

PSTricks

pst-am

A PSTricks package for drawing Modulations and Demodulations;
v.1.02

September 4, 2010

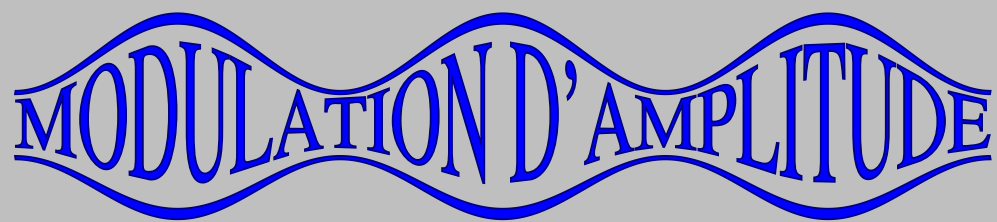

MODULATION D'AMPLITUDE

Package author(s):
Manuel Luque
Herbert Voß

Contents

1 Introduction	4
1.1 Example of a modulation	4
1.2 Schéma de principe du montage de la démodulation	5
2 Optional arguments	6
3 Possibility of drawing the curves in black on white	7
4 Le dessin de l'enveloppe	8
5 Le signal redressé	10
6 Le signal démodulé	11
7 L'influence de R et C sur la qualité de la démodulation	13
8 Suppression de la composante continue	15
9 Le phénomène de surmodulation	16
10 XY mode	18
11 Deux autres exemples	19
12 Les styles	21
13 List of all optional arguments for pst-am	22
References	22

pst-am allows the simulation of modulated and demodulated amplitude of the radio waves. You can choose several possible parameters and plot the following curves:

- modulated signals;
- wave carrier;
- signal modulation;
- signal recovering;
- signal demodulation.

The main command is called `\psAM [Options]` and has different options, including allowing view table of the used values, are detailed thereafter. The macro was written directly in PostScript¹.

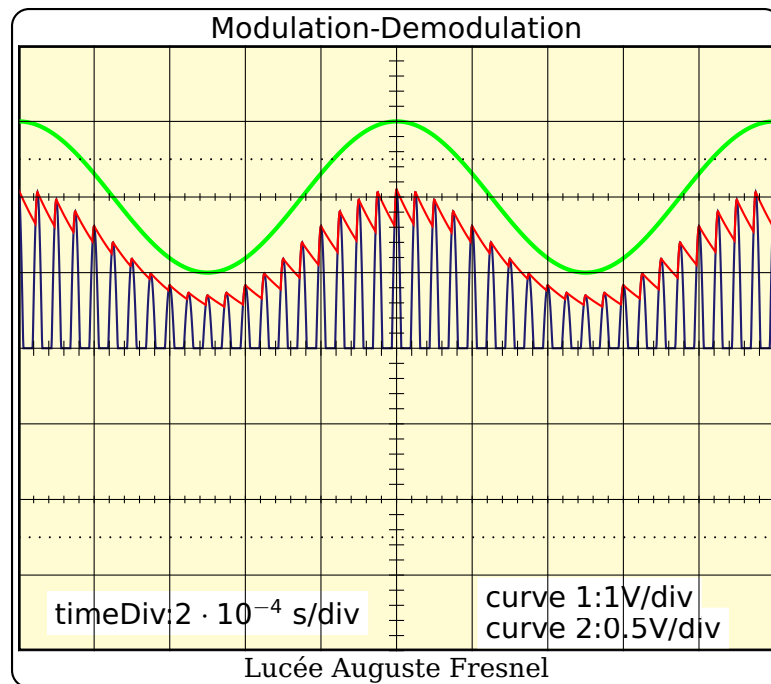

```
1 \psAM[SignalModulant,timeDiv=2e-4,SignalRedresse,SignalDemodule,  
2 voltDivY2=0.5,R=4700]
```

¹ Original idea by Peter Kleiweg and inspired by discussions on <http://melusine.eu.org/cgi-bin/mailman/listinfo/syracuse>

1 Introduction

1.1 Example of a modulation

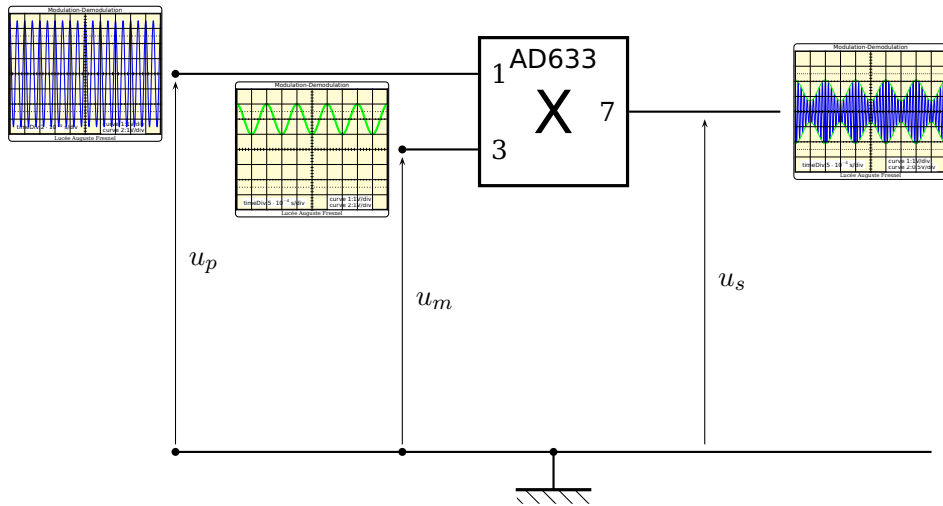

- l'onde **porteuse**, onde sinusoïdale de haute fréquence (H.F.) et d'amplitude constante.

Elle est produite par l'oscillateur de l'émetteur :

$$u_p(t) = U_p \cos 2\pi F_p t$$

- **le signal modulant** (signal B.F. à transmettre), considéré comme une onde sinusoïdale de la forme :

$$u_m(t) = U_m \cos 2\pi F_m t + U_0$$

- Le premier terme $u_m(t) = U_m \cos 2\pi F_m t$ représente le signal à transmettre.
- U_0 est la tension de décalage ou *offset*.

Un circuit électronique, appelé **multiplieur**, donne en sortie une tension :

$$u_s(t) = k \times u_p(t) \times u_m(t)$$

La tension obtenue à la sortie est de la forme :

$$u_s = k \cdot U_p \cos 2\pi F_p t \cdot (U_m \cos 2\pi F_m t + U_0)$$

Cette expression est mise sous la forme :

$$u_s(t) = A(1 + m \cos 2\pi F_m t) \cos 2\pi F_p t$$

avec :

- $A = kU_0 \cdot U_p$;

- $m = \frac{U_m}{U_0}$: **taux de modulation**

1.2 Schéma de principe du montage de la démodulation

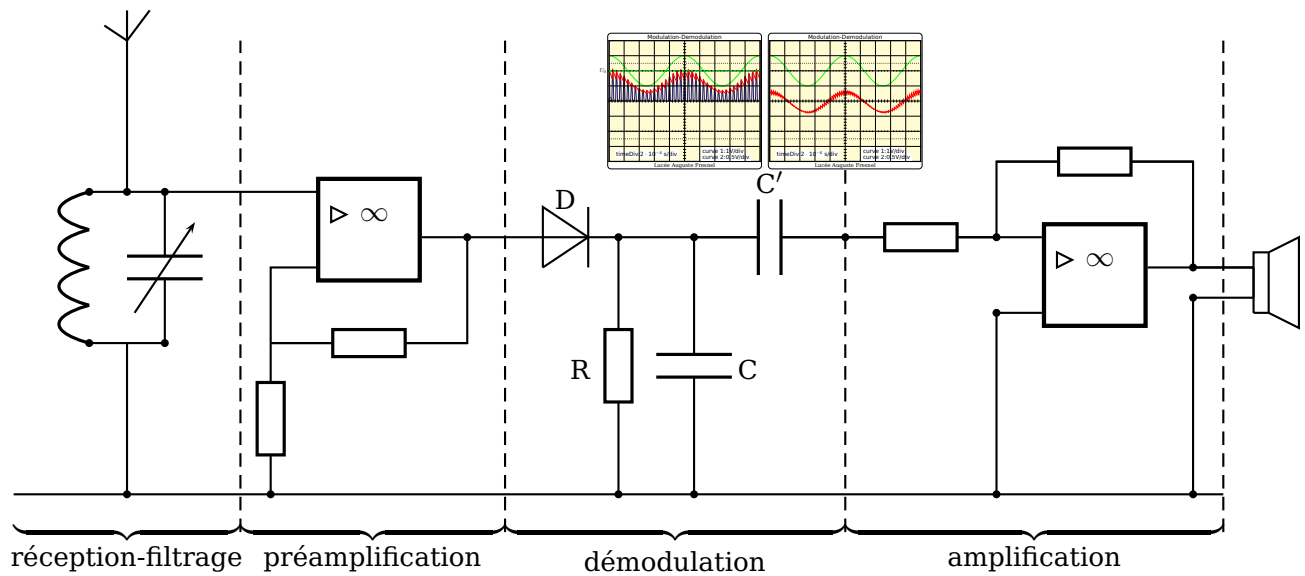

2 Optional arguments

<i>Name</i>	<i>type</i>	<i>default</i>	<i>description</i>
Up	number	3.5	carrier amplitude in V
Um	number	1	smodulated signal amplitude in V
Fp	number	2e4	frequency of carrier wave in Hz
Fm	number	1e3	frequency of modulated signal in Hz
U0	number	2	offset in V
R	number	3.3e3	resistor in Ω
C	number	3.9e-8	capacitor in F
timeDiv	number	2e-4	time base in s/div
voltDivY1	number	1	coefficient for the amplification 1 in V/div
voltDivY2	number	1	coefficient for the amplification 2 en V/div
SignalModulant	boolean	false	trace of signal modulant (curve 1)
SignalModule	boolean	false	trace of signal module (curve 2)
SignalPorteuse	boolean	false	trace of signal module (curve 2)
SignalRedresse	boolean	false	trace of signal redressé (curve 2)
SignalDemodule	boolean	false	trace of signal demodulte (curve 2)
XY	boolean	false	positionne l'écran en mode XY
traceU	boolean	false	trace la ligne de décalage U_0
UMandUm	boolean	false	pour permettre le calcul de m
values	boolean	false	values as a tabular under the image
BW	boolean	false	output curves in black on white
Centering	boolean	false	image and optional values are centered
title	text	{}	a title for the lower line

3 Possibility of drawing the curves in black on white

Avec l'option BW. Lorsqu'on souhaite afficher une courbe, il suffit de rajouter son nom dans la liste des options.

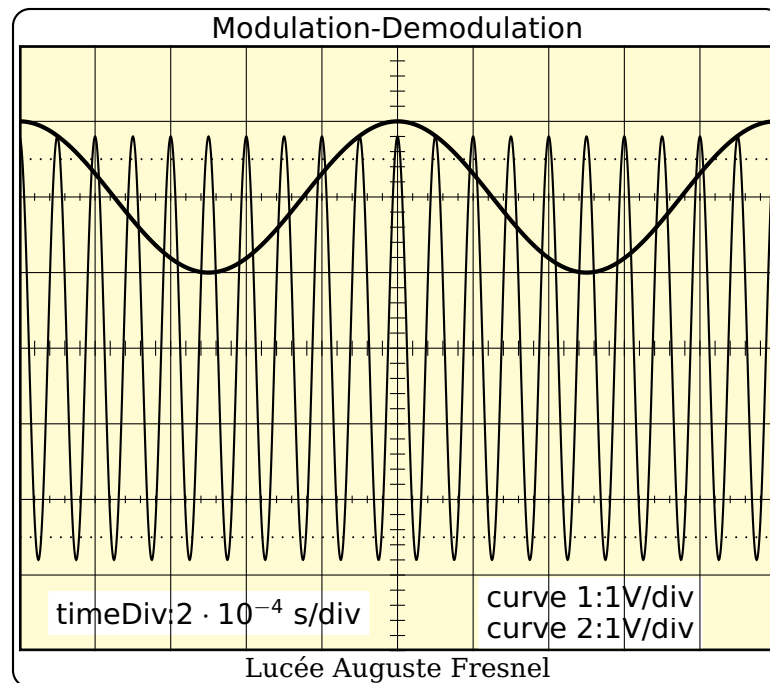

Amplitude porteuse	2,8 V
Amplitude audio	1 V
Frequence porteuse	$1 \cdot 10^4$ Hz
Frequence audio	$1 \cdot 10^3$ Hz
Decalage(U_0)	2 V
R	3300 Ω
C	$3,9 \cdot 10^{-8}$ F

```
\psAM[SignalModulant,SignalPorteuse,Up=2.8,frequencePorteuse=1e4,values,BW]
```

4 Le dessin de l'enveloppe

Avec l'option enveloppe.

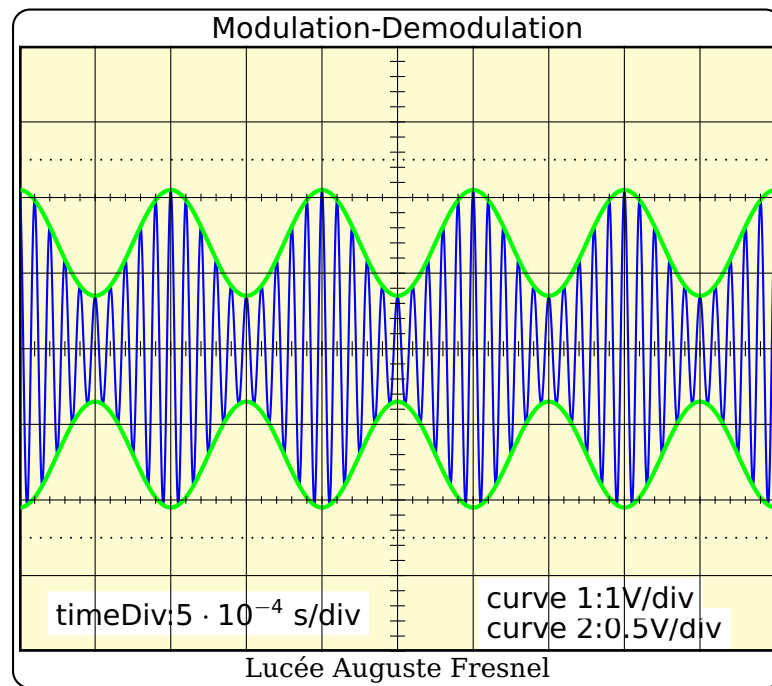

```
\psAM[SignalModule,enveloppe,frequencePorteuse=1e4,voltDivY2=0.5,timeDiv=5e-4]
```

L'option `UMandUm` permettra de déterminer facilement le taux de modulation.

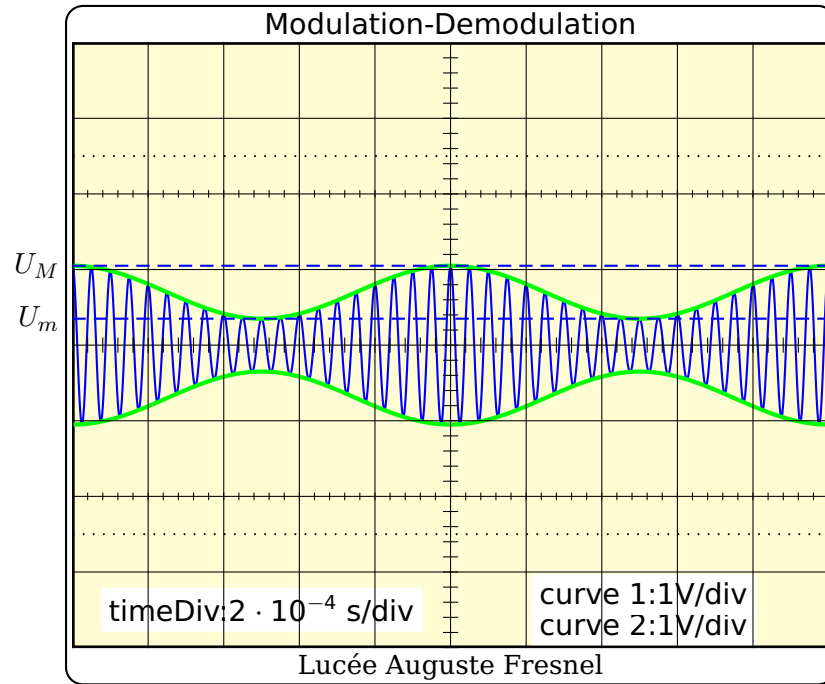

```
\psAM[SignalModule,enveloppe,UMandUm]
```

5 Le signal redressé

Avec l'option SignalRedresse.

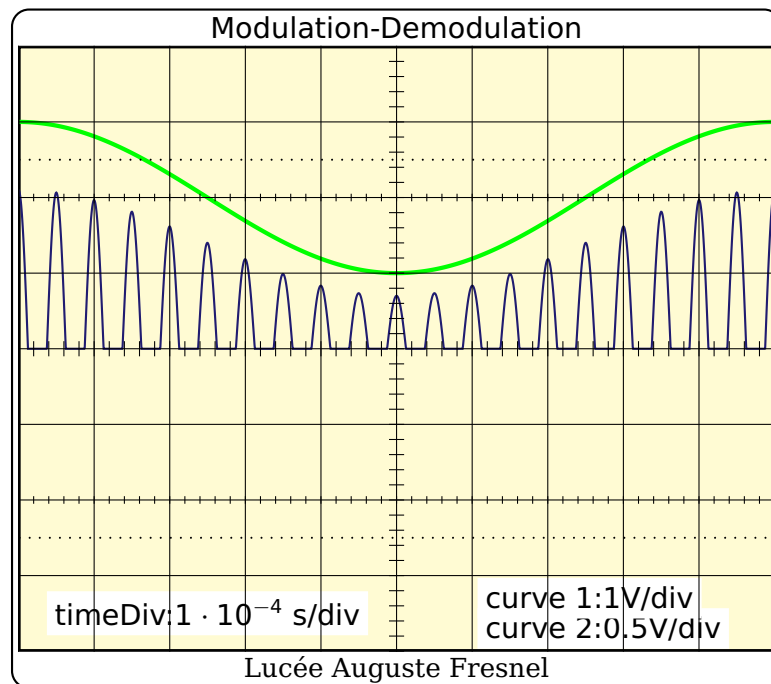

Amplitude porteuse	3,5 V
Amplitude audio	1 V
Frequence porteuse	$2 \cdot 10^4$ Hz
Frequence audio	$1 \cdot 10^3$ Hz
Decalage(U_0)	2 V
R	3300 Ω
C	$3,9 \cdot 10^{-8}$ F

```
\psAM[SignalModulant,timeDiv=1e-4,SignalRedresse,voltDivY2=0.5,values]
```

6 Le signal démodulé

Avec l'option SignalDemodule et, en exemple, deux possibilités en fonction du choix de la base de temps.

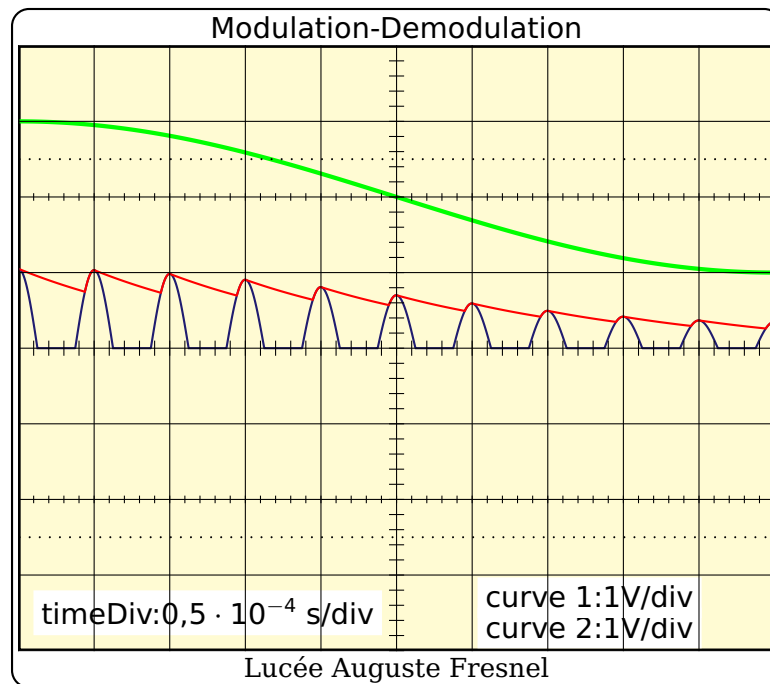

Amplitude porteuse	3,5 V
Amplitude audio	1 V
Frequence porteuse	$2 \cdot 10^4$ Hz
Frequence audio	$1 \cdot 10^3$ Hz
Decalage(U_0)	2 V
R	3 300 Ω
C	$3,9 \cdot 10^{-8}$ F

```
1 \psAM[SignalModulant,timeDiv=0.5e-4,SignalRedresse,SignalDemodule,values]
```

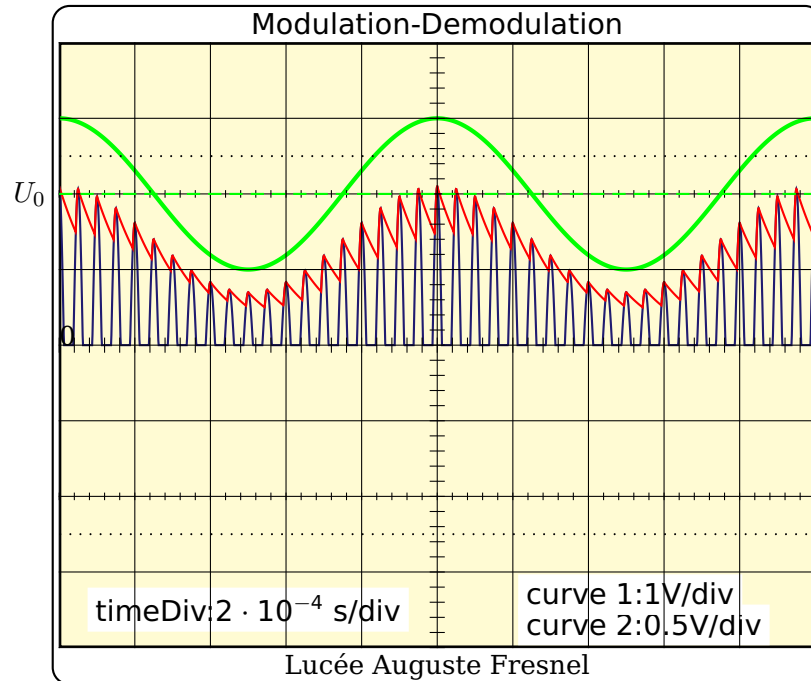

Amplitude porteuse	3,5 V
Amplitude audio	1 V
Frequence porteuse	$2 \cdot 10^4$ Hz
Frequence audio	$1 \cdot 10^3$ Hz
Decalage(U_0)	2 V
R	3300 Ω
C	$3,9 \cdot 10^{-8}$ F

```

1 \psAM[SignalModulant,SignalRedresse,SignalDemodule,timeDiv=2e-4,
2  frequencePorteuse=2e4,voltDivY2=0.5,values,traceU]

```

7 L'influence de R et C sur la qualité de la démodulation

Avec les paramètres R et C.

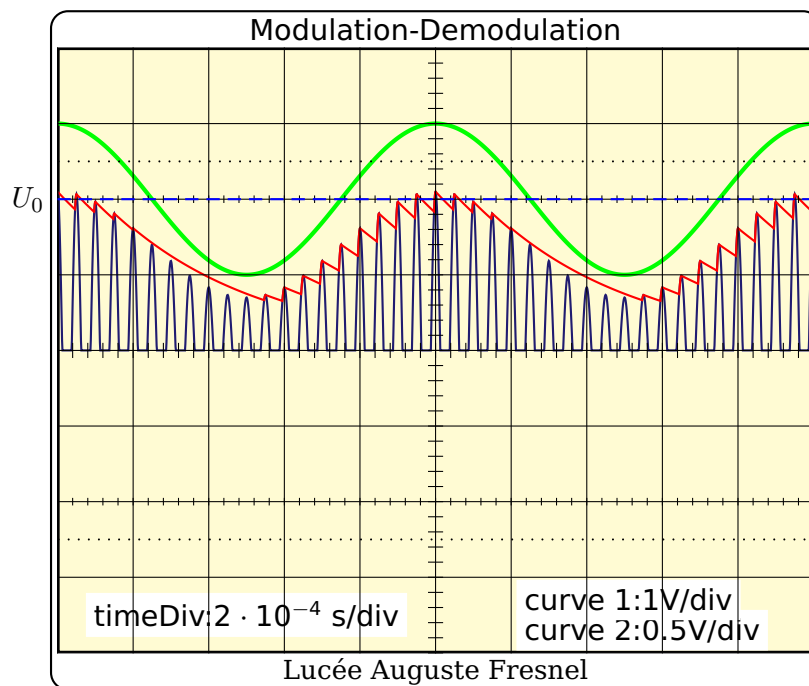

Amplitude porteuse	3,5 V
Amplitude audio	1 V
Frequence porteuse	$2 \cdot 10^4$ Hz
Frequence audio	$1 \cdot 10^3$ Hz
Decalage(U_0)	2 V
R	$1 \cdot 10^4 \Omega$
C	$3,9 \cdot 10^{-8}$ F

```

1 \psAM[SignalModulant,SignalRedresse,SignalDemodule,timeDiv=2e-4,
2   frequencePorteuse=2e4,voltDivY2=0.5,R=1e4,values]
3 \psline[linecolor=blue,linestyle=dashed](U01)(U02)
4 \uput[l](U01){$U_0$}

```

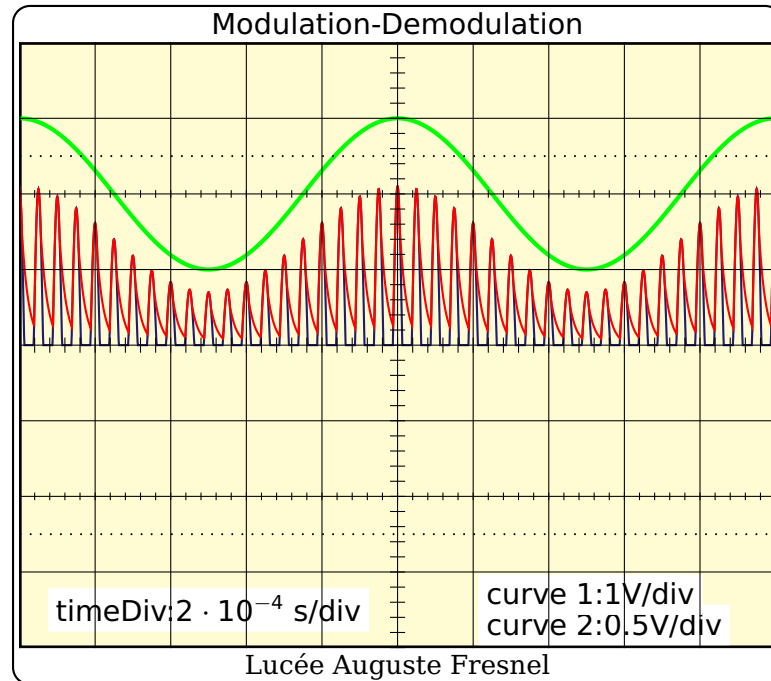

Amplitude porteuse	3,5 V
Amplitude audio	1 V
Frequence porteuse	$2 \cdot 10^4$ Hz
Frequence audio	$1 \cdot 10^3$ Hz
Decalage(U_0)	2 V
R	470 Ω
C	$3,9 \cdot 10^{-8}$ F

```

1 \psAM[SignalModulant,SignalRedresse,SignalDemodule,timeDiv=2e-4,
2  frequencePorteuse=2e4,voltDivY2=0.5,R=470,values]

```

8 Suppression de la composante continue

Avec l'option SignalFinal.

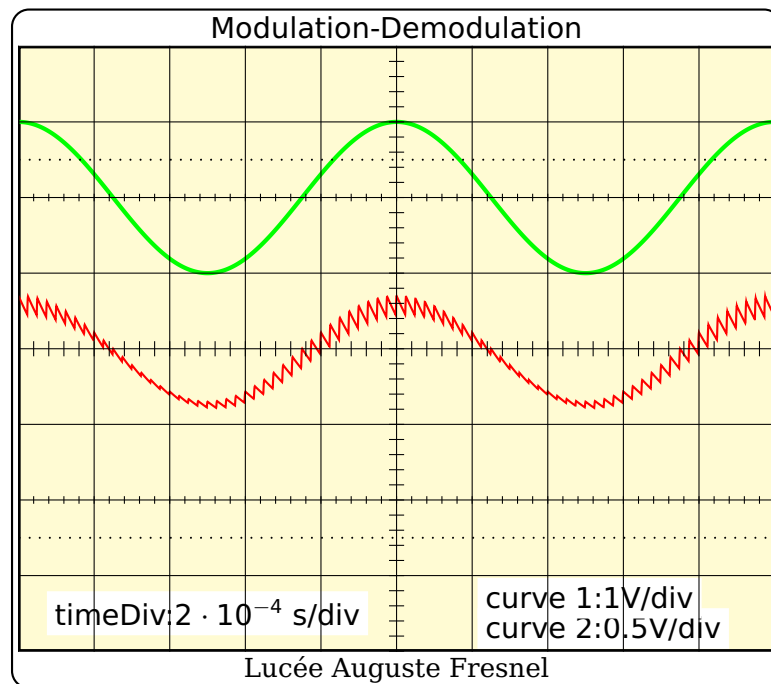

Amplitude porteuse	3,5 V
Amplitude audio	1 V
Frequence porteuse	$4 \cdot 10^4$ Hz
Frequence audio	$1 \cdot 10^3$ Hz
Decalage(U_0)	2 V
R	$4,7 \cdot 10^3 \Omega$
C	$3,9 \cdot 10^{-8}$ F

```
\psAM[SignalModulant,SignalFinal,timeDiv=2e-4,voltDivY2=0.5,frequencePorteuse=4e4,R=4.7e3,values]
```

9 Le phénomène de surmodulation

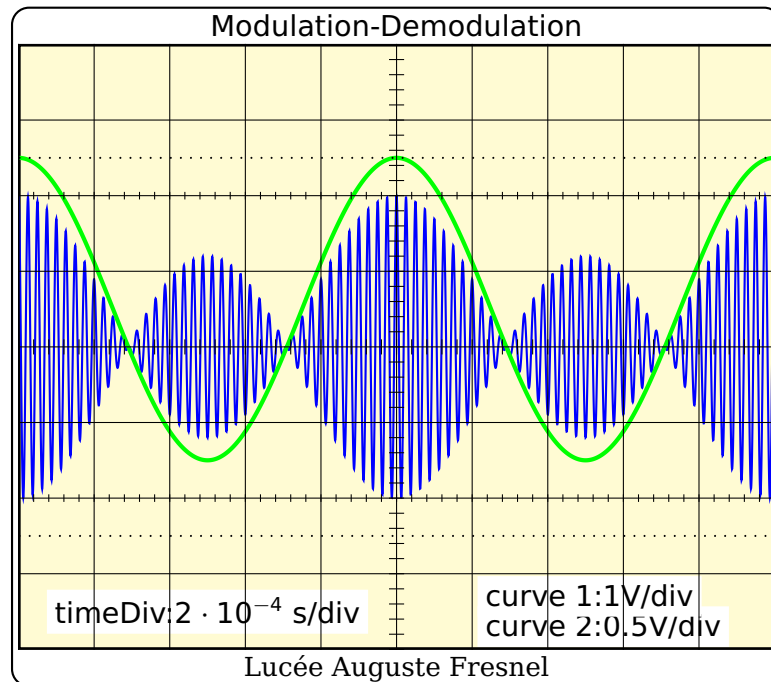

Amplitude porteuse	4 V
Amplitude audio	2 V
Frequence porteuse	$4 \cdot 10^4$ Hz
Frequence audio	$1 \cdot 10^3$ Hz
Decalage(U_0)	0,5 V
R	3 300 Ω
C	$3,9 \cdot 10^{-8}$ F

```

1 \psAM[SignalModulant,SignalModule,timeDiv=2e-4,U0=0.5,frequencePorteuse=4e4,
2 Up=4,Um=2,voltDivY2=0.5,values]

```

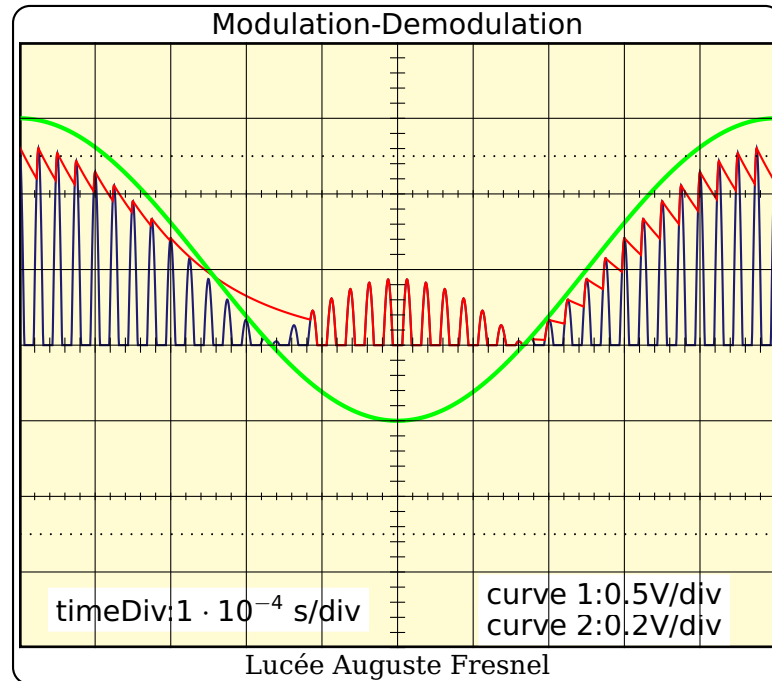

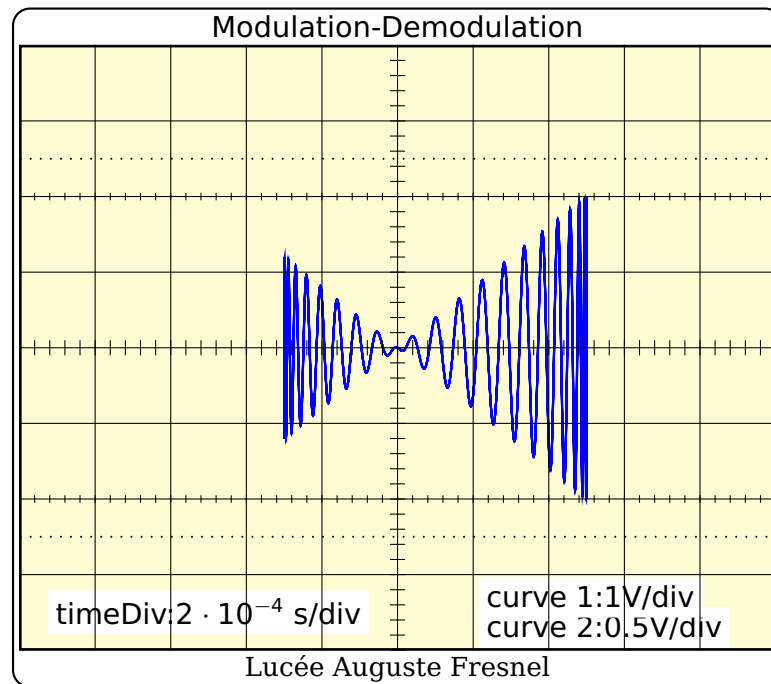

```
1 \psAM[SignalModulant,SignalRedresse,SignalDemodule,timeDiv=1e-4,U0=0.5,  
2 frequencePorteuse=4e4,voltDivY2=0.2,voltDivY1=0.5]
```

10 XY mode

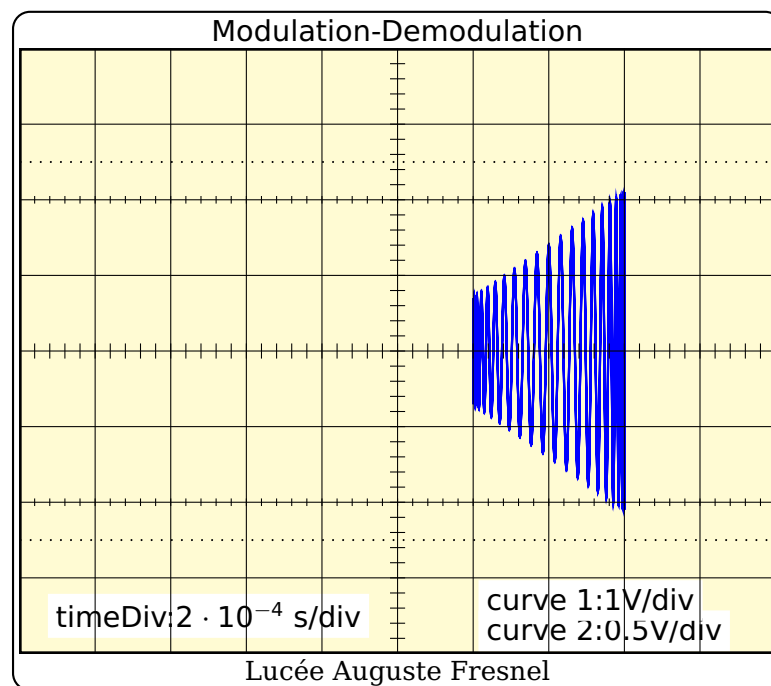

```
1 \psAM[XY,U0=0.5,frequencePorteuse=4e4,Up=4,Um=2,voltDivY2=0.5]
```



```
1 \psAM[XY,frequencePorteuse=4e4,voltDivY2=0.5,voltDivY1=1]
```

11 Deux autres exemples

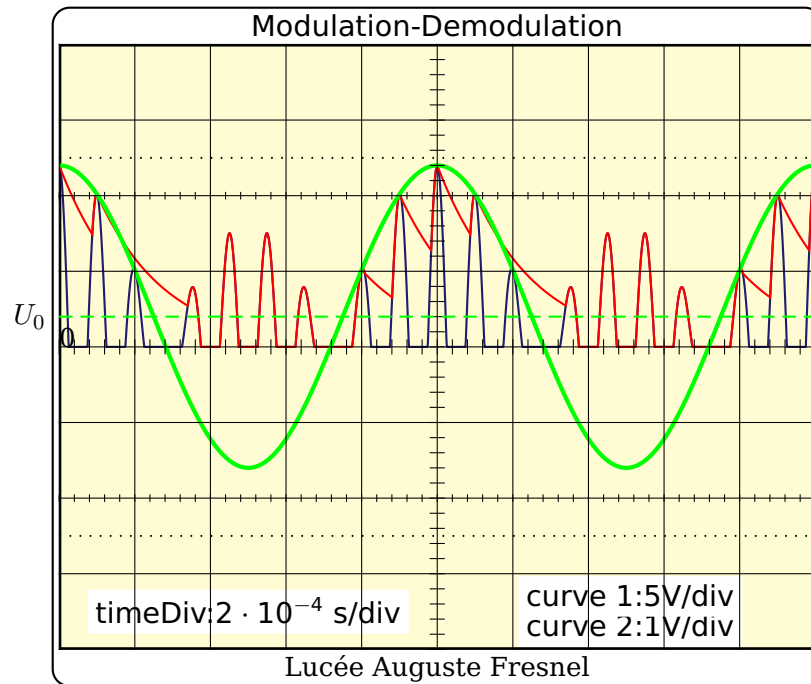

Amplitude porteuse	2 V
Amplitude audio	10 V
Frequence porteuse	$1 \cdot 10^4$ Hz
Frequence audio	$1 \cdot 10^3$ Hz
Decalage(U_0)	2 V
R	4 700 Ω
C	$3,9 \cdot 10^{-8}$ F

```

1 \psAM[SignalModulant,SignalRedresse,SignalDemodule,voltDivY2=1,voltDivY1=5,
2 timeDiv=2e-4,U0=2,R=4700,frequencePorteuse=1e4,Up=2,Um=10,values,traceU,
   values]

```

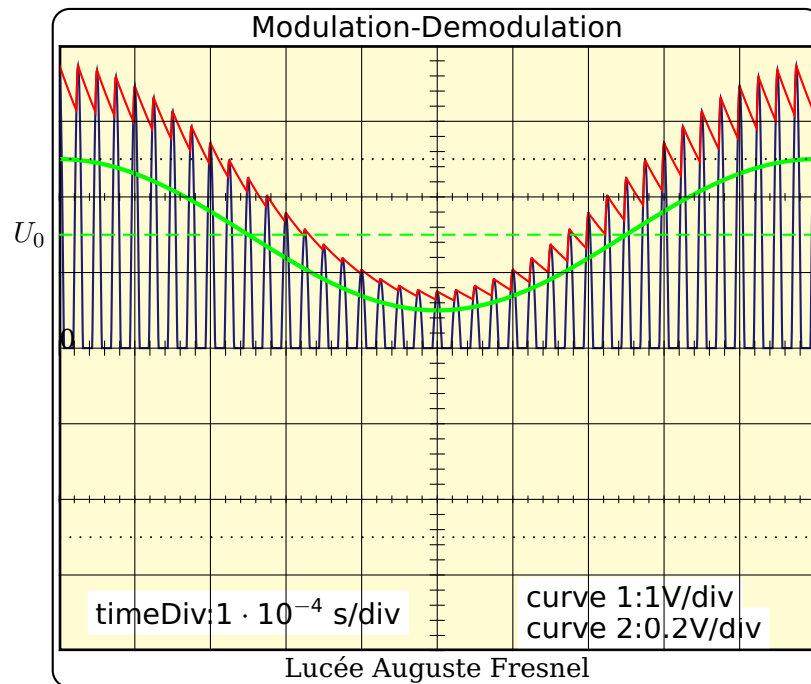

Amplitude porteuse	3 V
Amplitude audio	1 V
Frequence porteuse	$4 \cdot 10^4$ Hz
Frequence audio	$1 \cdot 10^3$ Hz
Decalage(U_0)	1,5 V
R	3300 Ω
C	$3,9 \cdot 10^{-8}$ F

```

1 \psAM[SignalModulant,SignalRedresse,SignalDemodule,timeDiv=1e-4,U0=1.5,
2   frequencePorteuse=4e4,Up=3,voltDivY2=0.2,traceU,values]

```

12 Les styles

À chaque courbe est associée un style, ce qui permet de les différencier. Le style du tracé d'une courbe pourra donc être modifié, simplement, en redéfinissant le `\newpsstyle` associé à la courbe avant son tracé.

De même, il sera possible de modifier l'allure de l'écran en redéfinissant les styles associés :

```
1 \newpsstyle{signalModulant}{plotpoints=1000,linecolor=green,linewidth=2\
  pslinewidth}
2 \newpsstyle{signalPorteuse}{plotpoints=2000,linecolor=blue}
3 \newpsstyle{signalRedresse}{plotpoints=2000,linecolor=Bleu}
4 \newpsstyle{signalDemodule}{plotpoints=4000,linecolor=red}
5 \newpsstyle{signalModule}{plotpoints=4000,linecolor=blue}
6 \newpsstyle{XY}{plotpoints=4000,linecolor=blue}
7 \newpsstyle{cadre}{framearc=0.05,linecolor=black}
8 \newpsstyle{screen}{fillstyle=solid,fillcolor=yellow!70!white!30}
```

13 List of all optional arguments for pst-am

Key	Type	Default
title	ordinary	[none]
frequencePorteuse	ordinary	2e4
frequenceAudio	ordinary	1e3
R	ordinary	3300
C	ordinary	3.9e-8
U0	ordinary	2
Up	ordinary	3.5
Um	ordinary	1
k	ordinary	0.1
timeDiv	ordinary	2e-4
voltDivY1	ordinary	1
voltDivY2	ordinary	1
Centering	boolean	true
SignalModule	boolean	true
SignalPorteuse	boolean	true
SignalRedresse	boolean	true
SignalDemodule	boolean	true
SignalModulant	boolean	true
SignalModule	boolean	true
SignalFinal	boolean	true
enveloppe	boolean	true
XY	boolean	true
traceU	boolean	true
UMandUm	boolean	true
values	boolean	true
BW	boolean	true

References

- [1] Hendri Adriaens. xkeyval package. [CTAN:/macros/latex/contrib/xkeyval](https://ctan.org/ctan-archive/macros/latex/contrib/xkeyval), 2004.
- [2] Denis Girou. Présentation de PSTricks. *Cahier GUTenberg*, 16:21–70, April 1994.
- [3] Michel Goossens, Frank Mittelbach, Sebastian Rahtz, Denis Roegel, and Herbert Voß. *The L^AT_EX Graphics Companion*. Addison-Wesley Publishing Company, Reading, Mass., 2007.
- [4] Alan Hoenig. *T_EX Unbound: L^AT_EX & T_EX Strategies, Fonts, Graphics, and More*. Oxford University Press, London, 1998.
- [5] Laura E. Jackson and Herbert Voß. Die plot-funktionen von pst-plot. *Die T_EXnische Komödie*, 2/02:27–34, June 2002.

-
- [6] Nikolai G. Kollock. *PostScript richtig eingesetzt: vom Konzept zum praktischen Einsatz*. IWT, Vaterstetten, 1989.
- [7] Frank Mittelbach and Michel Goossens et al. *The L^AT_EX Companion*. Addison-Wesley Publishing Company, Boston, second edition, 2004.
- [8] Frank Mittelbach and Michel Goossens et al. *Der L^AT_EX Begleiter*. Pearson Education, München, zweite edition, 2005.
- [9] Herbert Voß. Die mathematischen Funktionen von PostScript. *Die T_EXnische Komödie*, 1/02, March 2002.
- [10] Herbert Voß. *PSTricks Grafik für T_EX und L^AT_EX*. DANTE – Lob.media, Heidelberg/Hamburg, fifth edition, 2008.
- [11] Herbert Voß. *Mathematiksatz in L^AT_EX*. Lehmanns Media/DANTE, Berlin/Heidelberg, first edition, 2009.
- [12] Timothy Van Zandt. *PSTricks - PostScript macros for generic T_EX*. <http://www.tug.org/application/PSTricks>, 1993.
- [13] Timothy Van Zandt. *multido.tex - a loop macro, that supports fixed-point addition*. CTAN:/graphics/pstricks/generic/multido.tex, 1997.
- [14] Timothy Van Zandt. *pst-plot: Plotting two dimensional functions and data*. CTAN:/graphics/pstricks/generic/pst-plot.tex, 1999.
- [15] Timothy Van Zandt and Denis Girou. Inside PSTricks. *TUGboat*, 15:239–246, September 1994.

Index

BW, 6, 7

C, 6, 13

Centering, 6

enveloppe, 8

Fm, 6

Fp, 6

Keyword

BW, 6, 7

C, 6, 13

Centering, 6

enveloppe, 8

Fm, 6

Fp, 6

R, 6, 13

SignalDemodule, 6, 11

SignalFinal, 15

SignalModulant, 6

SignalModule, 6

SignalPorteuse, 6

SignalRedresse, 6, 10

timeDiv, 6

title, 6

traceU, 6

U0, 6

Um, 6

UMandUm, 6, 8

Up, 6

values, 6

voltDivY1, 6

voltDivY2, 6

XY, 6

Macro

\newpstyle, 21

\psAM, 3

\newpstyle, 21

Package

pst-am, 3

\psAM, 3

pst-am, 3

R, 6, 13

SignalDemodule, 6, 11

SignalFinal, 15

SignalModulant, 6

SignalModule, 6

SignalPorteuse, 6

SignalRedresse, 6, 10

timeDiv, 6

title, 6

traceU, 6

U0, 6

Um, 6

UMandUm, 6, 8

Up, 6

values, 6

voltDivY1, 6

voltDivY2, 6

XY, 6