



The ATM Forum
Technical Committee

Private Network-Network Interface
Specification Version 1.1
(PNNI 1.1)

With Revision Marks
Relative to af-pnni-0055.000

af-pnni-0055.001
April 2002

(Contents are Identical to af-pnni-0055.002)

© 2002 by The ATM Forum. The ATM Forum hereby grants its members the limited right to reproduce in whole, but not in part, this specification for its members internal use only and not for further distribution. This right shall not be, and is not, transferable. All other rights reserved. Except as expressly stated in this notice, no part of this document may be reproduced or transmitted in any form or by any means, or stored in any information storage and retrieval system, without the prior written permission of The ATM Forum.

The information in this publication is believed to be accurate as of its publication date. Such information is subject to change without notice and The ATM Forum is not responsible for any errors. The ATM Forum does not assume any responsibility to update or correct any information in this publication. Notwithstanding anything to the contrary, neither The ATM Forum nor the publisher make any representation or warranty, expressed or implied, concerning the completeness, accuracy, or applicability of any information contained in this publication. No liability of any kind shall be assumed by The ATM Forum or the publisher as a result of reliance upon any information contained in this publication.

The receipt or any use of this document or its contents does not in any way create by implication or otherwise:

- Any express or implied license or right to or under any ATM Forum member company's patent, copyright, trademark or trade secret rights which are or may be associated with the ideas, techniques, concepts or expressions contained herein; nor
- Any warranty or representation that any ATM Forum member companies will announce any product(s) and/or service(s) related thereto, or if such announcements are made, that such announced product(s) and/or service(s) embody any or all of the ideas, technologies, or concepts contained herein; nor
- Any form of relationship between any ATM Forum member companies and the recipient or user of this document.

Implementation or use of specific ATM standards or recommendations and ATM Forum specifications will be voluntary, and no company shall agree or be obliged to implement them by virtue of participation in The ATM Forum.

The ATM Forum is a non-profit international organisation accelerating industry cooperation on ATM technology. The ATM Forum does not, expressly or otherwise, endorse or promote any specific products or services.

NOTE: The user's attention is called to the possibility that implementation of the ATM interoperability specification contained herein may require use of an invention covered by patent rights held by ATM Forum Member companies or others. By publication of this ATM interoperability specification, no position is taken by The ATM Forum with respect to validity of any patent claims or of any patent rights related thereto or the ability to obtain the license to use such rights. ATM Forum Member companies agree to grant licenses under the relevant patents they own on reasonable and non discriminatory terms and conditions to applicants desiring to obtain such a license. For additional information contact:

The ATM Forum
Worldwide Headquarters

The address of which can be found at: <http://www.atmforum.com/contactfs1.html>

Acknowledgements

For PNNI 1.0, ~~The-the~~ PNNI SWG was chaired by Mike Goguen. Doug Dykeman was the editor for the PNNI Routing related sections of the document, and Rao Cherukuri for PNNI Signalling. The official meeting minutes were taken by Jason Jeffords.

The following people made significant technical contributions to the PNNI 1.0 specification:

Masuma Ahmed	Juha Heinanen	Russell Pretty
Anthony Alles	Tom Helstern	Tony Przygienda
Francois Audet	Michael Hluchyj	John Rutemiller
Tomas Berggren	Eric Hoffman	Abdallah Saleh
Caralyn Brown	Heinrich Hummel	Bill Salkewicz
David Bucciero	Nick Huslak	Hal Sandick
Ross Callon	Jason Jeffords	Shirish Sathaye
Rao Cherukuri	Martin Johnsson	Ross Schibler
Ashok Chippa	Claude Kawa	Jean-Bernard Schmitt
Rob Coltun	John Keene	Stephen Shew
David Cypher	Walter Kmitl	F. Y. Simon
Roger Dev	Paul Koning	Kumar Sivarajan
R. Dianda	Garry Kump	Ethan Spiegel
John Drake	Whay Lee	Ed Sullivan
Tim Dwight	Fong-Ching Liaw	Hiroshi Suzuki
Doug Dykeman	Sandrine Masson	George Swallow
John Elwell	Keith McCloghrie	Ted Tedijanto
Robert Epley	Dave McDysan	Kamlesh Tewani
Norman Finn	John Moy	Marek Tomaszewski
Mike Goguen	Raj Nair	Joachim Wagner
Dan Grossman	Maryann Perez	James Watt
Joel Halpern	Drew Perkins	David Wells
S. Kamran Hasan	Bernhard Petri	Malcolm Wiles
Tim Hefel	Paul Phillips	

For PNNI 1.1, the Control Signalling working group was chaired by Gert Öster. The specification was jointly edited by Thomas Cornély and Gert Öster. The minutes at related working group meetings were recorded by Thomas Cornély and Dave Paw.

The following people made significant technical contributions to the PNNI 1.1 specification:

<u>Ravi Raj Bhat</u>	<u>Ghassem Koleyni</u>
<u>Rao Cherukuri</u>	<u>Shawn McAllister</u>
<u>Ross Callon</u>	<u>Michael Osborne</u>
<u>Thomas Cornély</u>	<u>Gert Öster</u>
<u>David Cypher</u>	<u>Tony Przygienda</u>
<u>Robert Dianda</u>	<u>Carl Rajsic</u>
<u>Andrew Dolganow</u>	<u>Michal Rozenhal</u>
<u>Laurent Freléchoux</u>	<u>Yael Shavit</u>
<u>Dave King</u>	<u>Ethan Mickey Spiegel</u>
<u>Yoav Kluger</u>	<u>Malcolm Wiles</u>
<u>Paul Koning</u>	

Preface to PNNI 1.1

The PNNI 1.1 specification is contained in af-pnni-0055.002 and in af-pnni-0055.001. The contents of both documents are strictly identical, the only difference being that af-pnni-0055.001 contains revision marks to the existing PNNI 1.0 text of af-pnni-0055.000. In the unlikely case of discrepancies between the two documents, the text of af-pnni-0055.002 shall have precedence over the text of af-pnni-0055.001.

This new version of the PNNI specification, i.e., version 1.1, is comprised of:

- af-pnni-0055.000, *Private Network Network Interface Specification Version 1.0* (March 1996)
- af-pnni-0066.000, *Private Network Network Interface Specification Version 1.0 Addendum (Soft PVC MIB)* (September 1996)
- af-pnni-0075.000, *Addendum to PNNI V1.0 for ABR parameter negotiation* (January 1997)
- af-pnni-0081.000, *PNNI v1.0 Errata and PICS* (May 1997)
- af-cs-0127.000, *PNNI SPVC Addendum Version 1.0* (July 1999)
- Any additional technical or editorial corrections or updates
- Additional features (see Section 1.3 for more details)
- An updated “Mandatory and Optional Capabilities” Table (Annex G of PNNI 1.0) listing all currently specified PNNI capabilities and referencing the associated PNNI addenda

As a result, this specification supersedes the above specifications.

When PNNI 1.1 is supported, any reference to one of the above superseded specifications in the PNNI addenda listed below shall be understood as a reference to PNNI 1.1 instead. Similarly, when PNNI 1.1 is supported, any reference to UNI Signalling 4.0 [2] in those addenda shall be understood as a reference to UNI Signalling 4.1 [4]. Since Tables 5-18 (Information Group Summary), 5-19 (Information Groups in PNNI Packets) and 6-5 (Information Elements used in PNNI) of this document already reflect (and in some cases, update) changes specified in existing addenda to PNNI 1.0, the modifications to these tables as specified in the PNNI addenda listed below shall not apply to PNNI 1.1.

The purpose of the PNNI 1.1 specification is to provide an integrated basis for existing and future PNNI addenda. The following addenda are not integrated in this specification and are applicable to PNNI 1.1:

- af-cs-0102.000, *PNNI Addendum on PNNI/B-QSIG Interworking and Generic Functional Protocol for the Support of Supplementary Services* (October 1998)
- af-ra-0104.000, *PNNI Augmented Routing (PAR) Version 1.0* (January 1999)
- af-cs-0115.000, *PNNI Transported Address Stack Version 1.0* (May 1999)
- af-cs-0116.000, *PNNI Version 1.0 Security Signaling Addendum* (May 1999)
- af-ra-0123.000, *PNNI Addendum for Mobility Extensions Version 1.0* (May 1999)
- af-cs-0126.000, *PNNI Addendum for Generic Application Transport Version 1.0* (July 1999)
- af-cs-0140.000, *Network Call Correlation Identifier v1.0* (March 2000)
- af-cs-0141.000, *PNNI Addendum for Path and Connection Trace Version 1.0* (March 2000)
- af-cs-vmoa-0146.000, *Operation of the Bearer Independent Call Control (BICC) Protocol with SIG 4.0/PNNI 1.0/AINI* (July 2000)
- af-cs-0147.000, *UBR with MDCR Addendum to UNI Signalling 4.0, PNNI 1.0 and AINI* (July 2000)
- af-cs-0148.001, *Modification of Traffic Parameters for an Active Connection Signalling Specification (PNNI, AINI and UNI) – version 2.0* (May 2001)
- af-cs-0159.000, *Behavior Class Selector Signalling Version 1.0* (October 2000)
- af-cs-0167.000, *Guaranteed Frame Rate (GFR) Signalling Specification (PNNI, AINI and UNI), Version 1.0* (August 2001)
- af-ra-0171.000, *Addendum to PNNI 1.0 – Secure Routing* (November 2001)
- af-cs-0173.000, *Domain-Based Rerouting for Active Point- to-Point Calls Version 1.0* (August 2001)

The main enhancements of PNNI 1.1 are listed in Section 1.3. Note that in addition to the modifications contained in this document, since PNNI 1.1 extensively references the UNI Signalling 4.1 specification, unless explicitly stated otherwise, all coding changes specified in the UNI Signalling 4.1 specification are applicable to PNNI 1.1.

In af-pnni-0055.001, errata and text clarifications are highlighted using revision marks. Since some of these modifications have already been documented in other PNNI specifications, while others have never been documented before, different font colors are used to help identify the source of the modifications.

Additionally, "tags" are associated with revision marks. A "tag" is a superscript number following the revision mark it identifies. Tags should not be confused with references to notes which appear as superscript numbers in parentheses.

Example of a tagged revision mark : Else if the cause code indicates that the call was cleared due to a [signalling¹](#) error, and if upnode X...

Following is a list of the color-coded tags used in this document, along with the source they are associated with :

- **"1"** : is associated with modifications specified in "[PNNI v1.0 Errata and PICS](#)", af-pnni-0081.000;
- **"2"** : is associated with modifications specified in "[Addendum to PNNI for ABR parameters negotiation](#)". af-pnni-0075.000;
- **"3"** : is associated with errata and text clarifications which have not been published before;
- **"4"** : is associated with modifications specified in "[PNNI SPVC Addendum version 1.0](#)", af-cs-0127.000.

To avoid unnecessary use of tags, when a paragraph contains more than one untagged revision mark, the tag associated with the last revision mark in this paragraph applies to all of the untagged revision marks. The same principle also applies when a column of a table contains multiple untagged revision marks: the tag associated with the title cell applies to all the untagged revision marks in the column. When revision marks from different sources are located in the same paragraph (or column), those to which the previous rules do not apply are tagged individually.

Table of Contents

1.	INTRODUCTION	1
1.1	OVERVIEW	1
1.2	REFERENCE MODELS.....	1
1.3	PNNI STATUS	2
1.4	DOCUMENT ORGANIZATION	2
1.5	REFERENCES	3
2.	TERMINOLOGY.....	5
2.1	ABBREVIATIONS.....	5
2.2	DEFINITIONS.....	7
2.3	NOTATION AND CONVENTIONS.....	12
3.	PNNI ROUTING DESCRIPTION.....	13
3.1	PHYSICAL NETWORK.....	13
3.2	THE LOWEST HIERARCHICAL LEVEL.....	14
3.2.1	Peer Groups and Logical Nodes	14
3.2.2	Logical Links And Their Initialization	15
3.2.3	Information Exchange in PNNI	15
3.2.3.1	Nodal Information.....	15
3.2.3.2	Topology State Information	15
3.2.3.3	Reachability Information	16
3.2.3.4	Initial Topology Database Exchange	16
3.2.3.5	Flooding.....	16
3.2.4	Peer Group Leader.....	17
3.3	ONE HIERARCHICAL LEVEL UP	17
3.3.1	Logical Group Nodes.....	17
3.3.2	Feeding Information Up The Hierarchy.....	19
3.3.3	Feeding Information Down The Hierarchy.....	19
3.3.4	Uplinks (Revisiting The Hello Protocol)	19
3.3.5	PNNI Routing Control Channels	21
3.3.6	Revisiting Initial Topology Database Exchange.....	21
3.3.7	Horizontal Links	21
3.3.8	Topology Aggregation.....	22
3.3.8.1	Link Aggregation	22
3.3.8.2	Nodal Aggregation.....	22
3.4	COMPLETING THE PNNI ROUTING HIERARCHY	24
3.4.1	Progressing To The Highest Level Peer Group	24
3.4.2	Uplinks And Horizontal links Revisited	25
3.4.3	Recursion in the Hierarchy	26
3.5	ADDRESS SUMMARIZATION & REACHABILITY	26
3.5.1	General algorithm	26
3.5.2	Handling E.164 address prefixes and E.164 destination addresses.....	29
3.5.2.1	E.164 prefixes	29
3.5.3	Address Scoping	29
3.5.3.1	An Example of Address Summarization with Address Scoping	29
3.6	SINGLE NODE PERSPECTIVE	32
3.7	PATH SELECTION.....	33
3.7.1	Generic Connection Admission Control	34

4.	PNNI SIGNALLING DESCRIPTION.....	36
4.1	INTRODUCTION.....	36
4.2	OVERVIEW	36
4.3	ASSOCIATED SIGNALLING.....	37
4.4	DESIGNATED TRANSIT LISTS	37
4.5	CRANKBACK	37
4.6	SOFT PVPCs AND PVCCs.....	37
4.7	AN EXAMPLE OF CONNECTION SETUP WITH CRANKBACK.....	38
4.7.1	Example of a Connection Setup and Crankback of an Explicitly Routed Call	42
4.8	SUPPORTING ANYCAST WITH SCOPING	43
5.	PNNI ROUTING SPECIFICATION.....	45
5.1	GENERAL OPERATIONAL PROCEDURES	45
5.1.1	Timers.....	45
5.1.2	Packet Transmission	45
5.1.3	Packet Validation.....	45
5.2	ADDRESSING	45
5.2.1	ATM End System Addresses (AESAs).....	45
5.2.2	Address Prefixes	46
5.2.2.1	Address Prefixes for AESA Formats with Embedded Addresses.....	46
5.2.3	Matching an AESA with an Address Prefix.....	47
5.2.3.1	Matching an AESA with an Address Prefix for AESA Formats with Embedded Addresses	47
5.2.4	Node Addresses	47
5.3	IDENTIFIERS AND INDICATORS.....	48
5.3.1	Level Indicators	48
5.3.2	Peer Group Identifiers	48
5.3.3	Node Identifiers	49
5.3.4	Port Identifiers and Logical Links	50
5.3.5	Aggregation Tokens.....	50
5.3.6	Scope of Addresses.....	50
5.4	LOGICAL LINKS	51
5.5	PNNI ROUTING CONTROL CHANNELS.....	51
5.5.1	Specification of the AAL used by the PNNI Routing Control Channel.....	51
5.5.2	Traffic Contract for RCCs over Physical Links	52
5.5.3	Traffic Contract for RCCs over VPCs	52
5.5.4	SVCC-Based RCC Connection Establishment Overview.....	52
5.5.4.1	SETUP Message Contents	53
5.5.4.1.1	AAL Parameters	53
5.5.4.1.2	ATM Traffic Descriptor	53
5.5.4.1.3	Broadband Bearer Capability	54
5.5.4.1.4	Broadband Low Layer Information	54
5.5.4.1.5	QoS Parameter	55
5.5.4.1.6	Extended QoS Parameters	55
5.5.4.1.7	End-to-End Transit Delay	55
5.5.4.1.8	Called Party Number.....	55
5.5.4.1.9	Calling Party Number.....	55
5.5.4.1.10	Connection Identifier	55
5.5.4.1.11	DTL.....	55
5.5.4.2	CONNECT Message Contents.....	56
5.5.4.2.1	AAL Parameters	56
5.5.4.2.2	Broadband Low Layer Information	56
5.5.4.2.3	Connection Identifier	56
5.5.4.3	RELEASE and RELEASE COMPLETE Message Contents	56
5.5.5	SVCCs when One End is not an LGN	56
5.5.6	Establishing and Maintaining SVCCs between Logical Group Nodes	57
5.5.6.1	SVCC Establishment	57

5.5.6.2	Inconsistent Information and Partitioned Neighbor Peer Groups	58
5.5.6.3	Detailed Mechanisms for Establishment and Maintenance of SVCCs.....	58
5.6	THE HELLO PROTOCOL	60
5.6.1	PNNI Version Negotiation	60
5.6.2	Hellos Over Physical Links and VPCs.....	60
5.6.2.1	The Hello State Machine.....	60
5.6.2.1.1	The Hello Data Structure.....	60
5.6.2.1.2	Hello States	62
5.6.2.1.3	Events causing Hello state changes	63
5.6.2.1.4	Description of The Hello State Machine	66
5.6.2.2	Sending Hellos.....	69
5.6.2.2.1	Originating and sending ULIAs in Hellos on Outside Links.....	70
5.6.2.3	Receiving Hellos.....	71
5.6.2.3.1	Processing ULIAs received in Hellos on outside links.....	71
5.6.3	The LGN Hello Protocol	72
5.6.3.1	SVCC-Based RCC Hello Protocol.....	72
5.6.3.1.1	The SVCC-Based RCC Hello Data Structure	73
5.6.3.1.2	SVCIntegrityTimer.....	74
5.6.3.1.3	Loss of Neighbor Relationship.....	74
5.6.3.2	LGN Horizontal Link Hello Protocol	74
5.6.3.2.1	The LGN Horizontal Link Hello Data Structure	75
5.6.3.2.2	LGN Horizontal Link States.....	76
5.6.3.2.3	LGN Horizontal Link Events	77
5.6.3.2.4	Description of The Horizontal Link Hello State Machine.....	79
5.6.3.3	Overall Procedures.....	81
5.7	DATABASE SYNCHRONIZATION	81
5.7.1	The Neighboring Peer Data Structure.....	82
5.7.2	Neighboring Peer States	84
5.7.3	Events causing neighboring peer state changes	85
5.7.4	The Neighboring Peer State Machine	86
5.7.5	Sending Database Summary Packets	88
5.7.6	Receiving Database Summary Packets	89
5.7.7	Sending PTSE Request Packets.....	92
5.7.8	Receiving PTSE Request Packets.....	92
5.8	TOPOLOGY DESCRIPTION AND DISTRIBUTION.....	92
5.8.1	Topology Information.....	92
5.8.1.1	Topology State Parameters	93
5.8.1.1.1	Link State Parameters.....	93
5.8.1.1.2	Nodal State Parameters	93
5.8.1.1.3	Resource Availability Information Group (RAIG).....	94
5.8.1.1.3.1	Resource Availability Information Group Flags.....	94
5.8.1.1.3.2	Cell Delay Variation (CDV).....	94
5.8.1.1.3.3	Maximum Cell Transfer Delay (maxCTD).....	94
5.8.1.1.3.4	Administrative Weight (AW)	94
5.8.1.1.3.5	Cell Loss Ratio for CLP=0 (CLR ₀)	95
5.8.1.1.3.6	Cell Loss Ratio for CLP=0+1 (CLR ₀₊₁)	95
5.8.1.1.3.7	Maximum Cell Rate (maxCR).....	95
5.8.1.1.3.8	Available Cell Rate (AvCR).....	95
5.8.1.1.3.9	Cell Rate Margin (CRM).....	95
5.8.1.1.3.10	Variance Factor (VF)	95
5.8.1.2	Nodal Information.....	96
5.8.1.2.1	ATM End System Address of the Node	96
5.8.1.2.2	Leadership Priority.....	96
5.8.1.2.3	Nodal Information Flags	96
5.8.1.2.4	Preferred Peer Group Leader Node ID.....	97
5.8.1.2.5	Next Higher Level Binding Information	97
5.8.1.2.5.1	Parent Logical Group Node ID.....	97
5.8.1.2.5.2	Parent Logical Group Node's ATM End System Address.....	97
5.8.1.2.5.3	Parent Peer Group ID	97

5.8.1.2.5.4	Node ID of PGL of Parent Peer Group.....	97
5.8.1.3	Reachability Information	97
5.8.1.3.1	Internal Reachable Addresses.....	98
5.8.1.3.2	Exterior Reachable ATM Addresses	99
5.8.2	PTSPs and PTSEs.....	100
5.8.2.1	PTSPs.....	100
5.8.2.2	PTSEs	100
5.8.2.2.1	PTSE Header Contents.....	100
5.8.2.2.2	PTSE Checksum algorithm	101
5.8.2.2.3	PTSE identification and PTSE instance identification	101
5.8.2.2.4	Comparison of PTSE instances	101
5.8.3	Flooding.....	102
5.8.3.1	Overview.....	102
5.8.3.2	Sending PTSPs.....	102
5.8.3.3	Receiving a PTSP	103
5.8.3.4	Processing of Peer Retransmission List	104
5.8.3.5	Sending of PTSE Acknowledgments	105
5.8.3.6	Receiving Acknowledgment Packets	105
5.8.3.7	Origination of a New PTSE or a new PTSE Instance	105
5.8.3.8	Expiration of a PTSE's Lifetime.....	106
5.8.3.9	Removal of PTSEs from the topology database.....	106
5.8.3.10	Handling of PTSE sequence number wraparound	106
5.8.4	Aging PTSEs in the Topology Database.....	107
5.8.4.1	Computing the Remaining Lifetime of a PTSE.....	107
5.8.4.2	Refreshing Self-originated PTSEs	107
5.8.5	Triggered Updates of Topology Information.....	107
5.8.5.1	Significant Change Events for PNNI Topology State Elements	108
5.8.5.2	Processing Significant Changes to PTSEs	108
5.8.5.2.1	Changes in Nodal Information Groups.....	108
5.8.5.2.2	Changes in Internal Reachable ATM Addresses IGs.....	108
5.8.5.2.3	Changes in Exterior Reachable ATM Addresses IGs.....	108
5.8.5.2.4	Changes in other information groups	109
5.8.5.2.5	Changes to Resource Availability Information.....	109
5.8.5.2.5.1	Administrative Weight (AW)	109
5.8.5.2.5.2	Cell Loss Ratio (CLR ₀).....	109
5.8.5.2.5.3	Cell Loss Ratio (CLR ₀₊₁).....	109
5.8.5.2.5.4	Available Cell Rate (AvCR).....	109
5.8.5.2.5.5	Maximum Cell Transfer Delay (maxCTD)	110
5.8.5.2.5.6	Cell Delay Variation (CDV).....	111
5.8.5.2.5.7	Maximum Cell Rate (maxCR).....	112
5.8.5.2.5.8	Cell Rate Margin (CRM) and Variance Factor (VF).....	112
5.9	ADVERTISING AND SUMMARIZING REACHABLE ADDRESSES	112
5.9.1	Scope of Advertisement of Addresses	112
5.9.2	Summary Address and Suppressed Summary Address	113
5.9.3	Native Addresses	113
5.9.4	Foreign Addresses	113
5.9.5	Group Addresses.....	113
5.9.6	Exterior Reachable Addresses	114
5.10	HIERARCHY.....	114
5.10.1	Peer Group Leader.....	114
5.10.1.1	Peer Group Leader Election Algorithm	114
5.10.1.1.1	The PGL Election Data Structure.....	114
5.10.1.1.2	PGL Election States	116
5.10.1.1.3	Events Causing PGL Election State Changes	118
5.10.1.1.4	The PGL Election State Machine.....	120
5.10.1.1.5	Sending a Nodal Information PTSE.....	123
5.10.1.1.6	Choosing Preferred PGL.....	123
5.10.1.2	Leadership Priority	124
5.10.1.2.1	Group Leader Increment	124
5.10.1.2.2	Distinguished Values and Range Restrictions.....	124

5.10.1.2.3	Range Recommendations	124
5.10.1.2.4	Implications of Hierarchy.....	124
5.10.1.3	Default Configuration Consistency	124
5.10.1.4	Operation Without a Peer Group Leader	125
5.10.1.5	Exchange of Nodal Hierarchy Information on Outside Links	125
5.10.2	Advertising Uplinks	125
5.10.2.1	Advertising Uplinks from Lowest Level Nodes.....	125
5.10.2.2	Reverse Direction Information in Uplinks.....	126
5.10.3	Topology Aggregation.....	127
5.10.3.1	Link Aggregation and Binding Information	127
5.10.3.2	Simple Node Representation	128
5.10.3.3	Complex Node Representation.....	128
5.10.4	Feeding Information Down the Hierarchy	130
5.10.4.1	Proxy Flush	131
5.10.4.2	Flushing PTSEs in a Multi-Level Hierarchy	133
5.11	PEER GROUP PARTITIONS.....	134
5.11.1	Representation of the partition in the hierarchy.....	134
5.11.2	Routing in the Presence of Partitions.....	134
5.11.3	What to Aggregate as Peer Group Leader	134
5.12	OPERATION OF A NODE WHEN IN A TOPOLOGY DATABASE OVERLOAD STATE.....	135
5.12.1	Requirement for operation in topology database overload state	135
5.12.1.1	Minimum state required.....	135
5.12.1.2	Disallowed Functions	135
5.12.1.3	PGL election.....	135
5.12.1.4	PTSP reception and transmission	135
5.12.1.5	Periodic resynchronization	135
5.12.2	Recommendations for operation in topology database overload state	136
5.12.2.1	Call processing	136
5.12.2.2	Topology database handling.....	136
5.13	PATH SELECTION.....	136
5.13.1	Eligible Entities for Path Selection.....	138
5.13.2	Link Constraints, Node Constraints, and Path Constraints	138
5.13.3	CLR Selection for CBR and VBR Service	138
5.13.4	Generic CAC Algorithm for CBR and VBR Services	139
5.13.4.1	Parameter Choice for GCAC	139
5.13.4.2	Complex GCAC	139
5.13.4.2.1	Algorithm.....	140
5.13.4.2.2	Special Cases	140
5.13.4.2.3	Optional Improvement to Algorithm.....	140
5.13.4.3	Simple GCAC.....	140
5.13.5	Generic CAC Algorithm for Best-Effort Service.....	141
5.13.5.1	Minimum Acceptable ATM Traffic Descriptor	141
5.14	PACKET FORMATS.....	141
5.14.1	Notation	141
5.14.2	Information Group Tags	142
5.14.2.1	Mandatory Tag	142
5.14.2.2	Summarizing Tag.....	143
5.14.2.3	Transitive Tag.....	143
5.14.2.4	Mandatory Non-Transitive Information Groups.....	144
5.14.2.5	Examples	144
5.14.2.5.1	Advisory Metrics and Attributes	144
5.14.2.5.2	Local Information Groups.....	144
5.14.2.5.3	User lists	144
5.14.2.5.4	Security Labels.....	145
5.14.2.6	Information Group Tag Bit Definitions	145
5.14.3	Information Group Summary.....	146
5.14.4	PNNI Packet Header.....	150
5.14.5	The Resource Availability Information Group	150

5.14.6	Uplink Information Attribute	152
5.14.7	Transit Network ID	152
5.14.8	PNNI Hellos	153
5.14.8.1	The Aggregation Token IG	154
5.14.8.2	The Nodal Hierarchy List IG	154
5.14.8.3	The LGN Horizontal Link Extension IG	155
5.14.9	PNNI Topology State Packets (PTSP)	156
5.14.9.1	Restricted Information Groups	157
5.14.9.1.1	The Nodal state parameters IG	157
5.14.9.1.2	The Nodal Information Group	158
5.14.9.1.3	The Internal Reachable ATM Addresses Information Group	159
5.14.9.1.4	The Exterior Reachable ATM addresses Information Group	160
5.14.9.1.5	The Horizontal Links Information Group	161
5.14.9.1.6	The Uplinks Information Group	161
5.14.9.2	Unrestricted Information Groups	161
5.14.9.3	Unknown Information Groups	162
5.14.9.4	Processing PTSEs Violating Restrictions	162
5.14.9.5	PTSE Error Scenarios	163
5.14.9.5.1	Nodal Info Group in Nodal Info PTSE	163
5.14.9.5.2	Next higher Level Binding IG in Nodal Info IG	163
5.14.9.5.3	Nodal State Parameters IG	164
5.14.9.5.4	Horizontal Link IG	164
5.14.9.5.5	Uplink IG	164
5.14.9.5.6	ULIA	164
5.14.9.5.7	RAIGs	165
5.14.9.6	Nodal Information PTSE and its connection to other PTSEs issued by the node	165
5.14.10	PTSE Acknowledgment Packets	165
5.14.11	Database Summary Packets	166
5.14.12	PTSE Request Packets	167
5.14.13	System Capabilities	168
6.	PNNI SIGNALLING SPECIFICATION	169
6.1	PNNI MODEL	169
6.1.1	Definitions	170
6.1.2	Protocol model	171
6.1.2.1	Signalling layer	171
6.1.2.2	Signalling adaptation layer	172
6.1.2.3	ATM layer	172
6.2	OVERVIEW OF CALL/CONNECTION CONTROL	172
6.2.1	ATM Point-to-point call states	172
6.2.1.1	Null (NN0)	172
6.2.1.2	Call Initiated (NN1)	172
6.2.1.3	Call Proceeding Sent (NN3)	172
6.2.1.4	Alerting Delivered (NN4)	172
6.2.1.5	Call Present (NN6)	172
6.2.1.6	Alerting Received (NN7)	173
6.2.1.7	Call Proceeding Received (NN9)	173
6.2.1.8	Active (NN10)	173
6.2.1.9	Release Request (NN11)	173
6.2.1.10	Release Indication (NN12)	173
6.2.2	States associated with global call reference	173
6.3	MESSAGE FUNCTIONAL DEFINITIONS AND CONTENTS	173
6.3.1	Messages for ATM point-to-point call and connection control	174
6.3.1.1	ALERTING	175
6.3.1.2	CALL PROCEEDING	175
6.3.1.3	CONNECT	176
6.3.1.4	RELEASE	177
6.3.1.5	RELEASE COMPLETE	177
6.3.1.6	SETUP	178

6.3.1.7	STATUS	180
6.3.1.8	STATUS ENQUIRY.....	180
6.3.1.9	NOTIFY.....	181
6.3.1.10	CONNECTION AVAILABLE.....	181
6.3.2	Additional or modified messages for the support of 64kbit/s based ISDN circuit mode services	182
6.3.2.1	ALERTING.....	182
6.3.2.2	CONNECT.....	183
6.3.2.3	PROGRESS	183
6.3.2.4	RELEASE.....	184
6.3.2.5	SETUP	184
6.3.3	Messages used with the global call reference	184
6.3.3.1	RESTART.....	185
6.3.3.2	RESTART ACKNOWLEDGE	185
6.3.4	Messages for Point-to-multipoint call and connection control.....	186
6.3.4.1	ADD PARTY.....	186
6.3.4.2	ADD PARTY ACKNOWLEDGE	187
6.3.4.3	PARTY ALERTING.....	188
6.3.4.4	ADD PARTY REJECT.....	188
6.3.4.5	DROP PARTY.....	189
6.3.4.6	DROP PARTY ACKNOWLEDGE	189
6.4	GENERAL MESSAGE FORMAT AND INFORMATION ELEMENT CODING	190
6.4.1	Overview	190
6.4.2	Protocol discriminator	190
6.4.3	Call reference.....	190
6.4.4	Message type and message length.....	190
6.4.4.1	Message type.....	190
6.4.4.2	Message length.....	190
6.4.5	Variable length information elements	191
6.4.5.1	Coding rules.....	191
6.4.5.2	Extension of codesets.....	193
6.4.5.3	Broadband locking shift procedures.....	193
6.4.5.4	Broadband non-locking shift procedures	193
6.4.5.5	ATC additional parameters	193
6.4.5.6	ATC setup parameters.....	193
6.4.5.7	Alternative ATM traffic descriptor	194
6.4.5.8	ATM adaptation layer parameters	194
6.4.5.9	ATM traffic descriptor	194
6.4.5.10	Broadband bearer capability	195
6.4.5.11	Broadband high layer information.....	195
6.4.5.12	Broadband low layer information	195
6.4.5.13	Broadband repeat indicator.....	195
6.4.5.14	Call state	196
6.4.5.15	Called party number	196
6.4.5.16	Called party subaddress.....	196
6.4.5.17	Calling party number	196
6.4.5.18	Calling party subaddress.....	197
6.4.5.19	Cause	197
6.4.5.20	Connected number.....	197
6.4.5.21	Connected subaddress	197
6.4.5.22	Connection identifier.....	197
6.4.5.23	Connection scope selection	197
6.4.5.24	End-to-end transit delay	198
6.4.5.25	Extended QoS parameters.....	199
6.4.5.26	Minimum acceptable ATM traffic descriptor	199
6.4.5.27	Notification indicator.....	199
6.4.5.28	Quality of service parameter	199
6.4.5.29	Restart indicator	199
6.4.5.30	Transit network selection.....	199
6.4.5.31	Generic identifier transport.....	200
6.4.5.32	User-user	200

6.4.5.33	Broadband report type	200
6.4.6	Information elements defined for PNNI	201
6.4.6.1	Calling party Soft PVPC or PVCC	201
6.4.6.2	Called party Soft PVPC or PVCC	203
6.4.6.3	Crankback	205
6.4.6.4	Designated transit list.....	209
6.4.7	Information Elements for the support of 64 kbit/s based circuit mode services.....	210
6.4.7.1	Narrow-band bearer capability.....	210
6.4.7.2	Narrow-band high layer compatibility	210
6.4.7.3	Narrow-band low layer compatibility	210
6.4.7.4	Progress indicator	210
6.4.8	Information Elements for Point-to-Multipoint Call/connection Control.....	210
6.4.8.1	Endpoint reference.....	210
6.4.8.2	Endpoint state	210
6.5	CALL/CONNECTION CONTROL PROCEDURES FOR ATM POINT-TO-POINT CALLS	210
6.5.1	Establishment of a signalling AAL	211
6.5.2	Call/connection establishment	211
6.5.2.1	Call/connection request.....	211
6.5.2.2	Connection identifier allocation/selection.....	211
6.5.2.2.1	Associated signalling.....	212
6.5.2.2.2	Non-associated signalling.....	213
6.5.2.2.2.1	Allocation for switched virtual channels	213
6.5.2.2.2.2	Allocation for switched virtual paths.....	214
6.5.2.2.3	Use of VPCIs	214
6.5.2.2.4	VPCI and VCI ranges.....	215
6.5.2.3	Service category, traffic parameter, and QoS selection procedures	215
6.5.2.3.1	Determination of service category.....	215
6.5.2.3.2	Allowed combination of bearer capabilities, traffic parameters, and QoS.....	215
6.5.2.3.3	Traffic parameter selection procedures during the call/connection establishment request	215
6.5.2.3.4	Procedures for negotiation of traffic parameters during call/connection setup	216
6.5.2.3.5	QoS parameter selection procedures	217
6.5.2.3.6	Traffic parameter selection procedures for ABR connections	219
6.5.2.3.7	Processing of Cumulative RM fixed round-trip time parameter for ABR connections	221
6.5.2.4	Call/connection proceeding	221
6.5.2.5	Call/connection alerting	222
6.5.2.6	Call/connection connected.....	222
6.5.2.6.1	Procedures for traffic parameter selection during call/connection acceptance	222
6.5.2.6.2	Procedures for negotiation of traffic parameters during call/connection acceptance.....	223
6.5.2.7	Failure of call establishment	224
6.5.2.8	Generic identifier transport procedures.....	224
6.5.3	Call/connection clearing	224
6.5.3.1	Terminology.....	224
6.5.3.2	Exception conditions.....	224
6.5.3.3	Clearing.....	224
6.5.3.4	Clear collision	225
6.5.4	Call/connection collisions.....	225
6.5.5	Restart Procedures	225
6.5.5.1	Sending RESTART.....	225
6.5.5.2	Receipt RESTART.....	225
6.5.5.3	Restart collision	225
6.5.6	Handling of error conditions.....	226
6.5.6.1	Protocol discrimination error	226
6.5.6.2	Message too short	226
6.5.6.3	Call reference error	226
6.5.6.3.1	Invalid call reference format.....	226
6.5.6.3.2	Call reference procedural errors	226
6.5.6.4	Message type or message sequence errors	226
6.5.6.5	Message length error.....	227
6.5.6.6	General information element errors	227
6.5.6.6.1	Information element sequence.....	227

6.5.6.6.2	Duplicated information elements.....	227
6.5.6.6.3	Coding standard error.....	227
6.5.6.7	Mandatory information element error	227
6.5.6.7.1	Mandatory information element missing.....	227
6.5.6.7.2	Mandatory information element content error.....	227
6.5.6.8	Non-mandatory information element errors.....	227
6.5.6.8.1	Unrecognized information element	228
6.5.6.8.2	Non-mandatory information element content error	228
6.5.6.8.3	Unexpected recognized information element	228
6.5.6.9	Signalling AAL reset.....	228
6.5.6.10	Signalling AAL failure	228
6.5.6.11	Status enquiry procedure	229
6.5.6.12	Receiving a STATUS message	229
6.5.7	Error procedures with explicit action indicator.....	229
6.5.7.1	Unexpected or unrecognized message type.....	229
6.5.7.1.1	Pass along procedures	229
6.5.7.1.2	Message error procedures with explicit action indicator	230
6.5.7.2	Information element error	230
6.5.7.2.1	Pass along procedures	230
6.5.7.2.2	Information element error handling procedures with explicit action indicator.....	231
6.5.8	Handling of messages with insufficient information.....	231
6.5.9	Network node call control requirements.....	231
6.5.10	Notification procedures	231
6.5.11	Notification of interworking	231
6.5.12	List of Timers	231
6.6	CALL/CONNECTION CONTROL PROCEDURES FOR POINT-TO-MULTIPOINT CALLS	231
6.6.1	Setup of the initial party.....	232
6.6.2	Adding a party	232
6.6.3	Party dropping	233
6.6.4	Restart procedures	233
6.6.5	Handling of error conditions.....	233
6.6.6	List of timers for point-to-multipoint.....	233
7.	ANNEX A: DESIGNATED TRANSIT LIST	234
7.1	TERMINOLOGY	234
7.2	INITIAL DTL PROCESSING	234
7.2.1	Procedures at the DTL originator	234
7.2.2	Procedures at an entry border node.....	236
7.2.3	Procedures at a node which is not the DTL originator or an entry border node	238
7.3	NEXT STEP IN DTL PROCESSING.....	238
7.4	RECOMMENDATIONS ON INCLUSION OF PORT IDS IN DTLs	239
7.5	PSEUDOCODE OF DTL PROCEDURES	240
7.6	EXTERIOR ROUTES AND DTLs	242
8.	ANNEX B: CRANKBACK PROCEDURES	243
8.1	SCOPE OF CRANKBACK PROCEDURES.....	243
8.2	CRANKBACK CAUSE.....	243
8.2.1	Reachability Errors	243
8.2.1.1	Destination unreachable and transit network unreachable	244
8.2.1.2	Next node unreachable.....	244
8.2.2	Resource Errors	245
8.2.2.1	Resource Errors Due To Service Category	245
8.2.2.2	Resource Errors Due to Traffic and QoS Parameters.....	245
8.2.2.3	Resource Errors Due to VPCI/VCI Allocation	245
8.2.3	DTL Processing Errors	245
8.3	PROCEDURES FOR CRANKBACK LEVEL AND BLOCKED TRANSIT.....	246
8.3.1	Procedures at the Point of Blocking	246

8.3.1.1	Blocking at a node	246
8.3.1.2	Blocking at the preceding end of a link.....	247
8.3.1.3	Blocking at the succeeding end of a link.....	247
8.3.2	Receiving a clearing message with a Crankback information element	247
8.3.2.1	Receiving a clearing message indicating blocking at this interface.....	247
8.3.2.2	Receiving a clearing message at the entry border node at the crankback level	248
8.3.2.2.1	Alternate routing	248
8.3.2.2.2	Crankback to next higher level.....	248
8.3.2.3	Additional procedures for point-to-multipoint calls/connections.....	249
8.3.3	Pseudocode of Crankback Procedures	250
8.4	CARRYING UPDATED TOPOLOGY STATE PARAMETERS IN CRANKBACK INFORMATION ELEMENT.....	252
8.5	TRIGGERING SIGNIFICANT CHANGE EVENT FOR RESOURCE AVAILABILITY INFORMATION ON CALL BLOCKING.....	253
9.	ANNEX C: SOFT PERMANENT VIRTUAL CONNECTION PROCEDURES	255
9.1	MESSAGES.....	256
9.2	PROCEDURES FOR POINT-TO-POINT SOFT PVPC/PVCCs	256
9.2.1	Initiating PVPC/PVCC establishment.....	256
9.2.2	Receiving a CONNECT message at the calling NI.....	256
9.2.3	Receiving a SETUP message at the called NI	256
9.2.3.1	Last PVPC segment allocation/selection.....	257
9.2.3.2	Last PVCC segment allocation/selection at non-frame relay interfaces.....	257
9.2.3.3	Last PVCC segment allocation/selection at frame relay interfaces	258
9.3	PROCEDURES FOR POINT-TO-MULTIPOINT SOFT PVPC/PVCCs	258
9.3.1	Adding a party at the originating interface.....	258
9.3.2	Set up of the first party	258
9.3.2.1	Receiving a CONNECT message at the calling NI.....	258
9.3.2.2	Receiving a SETUP message at the called NI.....	259
9.3.3	Adding a party	259
9.3.3.1	Receiving an ADD PARTY ACKNOWLEDGE message at the calling NI.....	259
9.3.3.2	Receiving an ADD PARTY message at the called NI.....	259
9.3.3.2.1	Last PVCC segment allocation/selection	259
9.3.3.2.2	Last PVPC segment allocation/selection	260
9.4	PROCEDURES AT INTERMEDIATE SWITCHES	260
9.5	COMPATIBILITY WITH PNNI 1.0 NODES NOT SUPPORTING AF-CS-0127.000.....	261
10.	ANNEX D: ARCHITECTURAL CONSTANTS	262
11.	ANNEX E: ARCHITECTURAL VARIABLES.....	263
12.	ANNEX F: CONFIGURATION OF THE PNNI HIERARCHY	265
12.1	CONSIDERATIONS WHEN USING AESAS WITH EMBEDDED ADDRESSES	266
13.	ANNEX G: PNNI MINIMUM SUBSETS	267
14.	ANNEX H: MANAGEMENT INFORMATION BASES	270
14.1	THE UPDATED PNNI MANAGEMENT INFORMATION BASE (AS IN AF-PNNI-0055.002.MIB).....	270
14.2	THE UPDATED SOFT PVC MANAGEMENT INFORMATION BASE (AS IN AF-PNNI-0055.002.MIBSOFT).....	362
15.	ANNEX I: PROTOCOL IMPLEMENTATION CONFORMANCE STATEMENT (PICS) PROFORMA	383
15.1	PNNI 1.1 PICS PROFORMA	383
15.1.1	Introduction	383
15.1.1.1	Scope	383
15.1.1.2	Normative References.....	383
15.1.1.3	Definitions	383
15.1.1.4	Conformance Statement.....	384

15.1.2	Identification of the Implementation.....	384
15.1.3	PICS Proforma.....	387
15.1.3.1	Global Statement of Conformance.....	387
15.1.3.2	Instructions for Completing the PICS Proforma.....	387
15.1.3.3	Switching System Subsets (SS).....	388
15.1.3.4	Optional Features (OPT).....	389
15.1.3.5	General Operational Procedures.....	390
15.1.3.6	Addressing.....	391
15.1.3.7	Identifiers and indicators.....	393
15.1.3.8	Logical Links.....	395
15.1.3.9	PNNI Routing Control Channels.....	396
15.1.3.10	The Hello Protocol.....	403
15.1.3.11	SVCC-Based RCC Hello Protocol.....	410
15.1.3.12	LGN Horizontal Link Hello Protocol.....	412
15.1.3.13	Overall Procedures.....	416
15.1.3.14	Database Synchronization.....	417
15.1.3.15	Topology Description and Distribution.....	426
15.1.3.16	Advertising and Summarizing Reachable Address.....	430
15.1.3.17	Hierarchy.....	431
15.1.3.18	Peer Group Partitions.....	437
15.1.3.19	Topology Database Overload.....	438
15.1.3.20	Path Selection.....	439
15.1.3.21	Packet Formats.....	441
15.1.3.22	Signalling.....	444
15.1.3.23	Messages functional definitions and contents.....	445
15.1.3.24	Call/Connection control procedures.....	447
15.1.3.25	Designated Transit Lists (Annex A).....	458
15.1.3.26	Crankback Procedures (Annex B).....	463
15.1.3.27	Soft PVC Procedures (Annex C).....	468
15.1.3.28	Soft PVC Point-to-Multipoint Procedures.....	470
15.1.3.29	Interoperability Questions.....	472
15.1.3.30	Enhanced Status Enquiry (Annex R).....	473
15.1.3.31	Explicitly Routed Calls (Annex S).....	477
15.1.3.32	Support of the OAM Traffic Descriptor (Annex T).....	478
15.2	FRAME RELAY SOFT PVC EXTENSION PICS PROFORMA.....	479
15.2.1	Roles.....	479
15.2.2	Major Capabilities.....	479
15.2.2.1	Information Element Encoding.....	479
15.2.2.2	Soft PVC procedures for Point-to-Point connections.....	479
16.	ANNEXES J TO P.....	482
17.	ANNEX Q: PNNI 1.1 SUPPORT OF ADMINISTRATIVE BOUNDARIES.....	483
17.1	PROCEDURES FOR NCCI SUPPORT AT PNNI INTERFACES BETWEEN ADMINISTRATIVE DOMAINS.....	483
17.2	PROCEDURES FOR UBR WITH MDCR SUPPORT AT PNNI INTERFACES BETWEEN ADMINISTRATIVE DOMAINS.....	483
17.3	PROCEDURES FOR BCS SUPPORT AT PNNI INTERFACES BETWEEN ADMINISTRATIVE DOMAINS.....	484
18.	ANNEX R: ENHANCED STATUS ENQUIRY.....	485
18.1	INTRODUCTION.....	485
18.2	SCOPE.....	485
18.3	CODING.....	485
18.3.1	Messages.....	485
18.3.1.1	STATUS.....	485
18.3.1.2	STATUS ENQUIRY.....	486
18.3.2	Information elements.....	486
18.3.2.1	Call State.....	486
18.3.2.2	Endpoint State.....	486
18.3.2.3	Reference list.....	486

18.4	PROCEDURE FOR POINT-TO-POINT CALLS	486
18.5	POINT-TO-MULTIPOINT PROCEDURES	487
18.5.1	Call state enquiry	487
18.5.2	Party state enquiry	487
18.6	COMPATIBILITY WITH NODES NOT SUPPORTING THE CAPABILITY	488
19.	ANNEX S: EXPLICITLY ROUTED CALLS.....	490
20.	ANNEX T: SUPPORT OF THE OAM TRAFFIC DESCRIPTOR	494
20.1	CODING	494
20.1.1	Messages.....	494
20.1.1.1	SETUP.....	494
20.1.1.2	CONNECT	494
20.1.2	Information element.....	494
20.1.2.1	OAM traffic descriptor	494
20.2	HANDLING OF THE OAM TRAFFIC DESCRIPTOR INFORMATION ELEMENT IN THE SETUP MESSAGE	494
20.3	HANDLING OF THE OAM TRAFFIC DESCRIPTOR INFORMATION ELEMENT IN THE CONNECT MESSAGE.....	495
20.4	COMPATIBILITY WITH NODES NOT SUPPORTING THE CAPABILITY	495
21.	APPENDIX A: EXAMPLES OF MESSAGE SEQUENCES	496
21.1	GENERAL	496
21.2	FINITE STATE MACHINE	496
21.3	EXAMPLE OF MESSAGE SEQUENCES.....	497
21.3.1	Successful Call Establishment	497
21.3.2	Unsuccessful Call Establishment	498
21.3.3	Normal call clearing (from originator).....	498
21.3.4	Call termination by a Private network	499
22.	APPENDIX B: DERIVATION OF GENERIC CONNECTION ADMISSION CONTROL.....	500
22.1	GENERIC CAC FOR CBR AND VBR SERVICE CATEGORIES.....	500
22.2	GENERIC CAC FOR UBR AND ABR SERVICE CATEGORIES	502
23.	APPENDIX C: GUIDELINES FOR TOPOLOGY AGGREGATION.....	503
23.1	DIAMETER AND RADIUS	503
23.2	PRESUMED NODAL STATE PARAMETERS.....	503
23.3	SIGNIFICANT EXCEPTIONS	503
23.4	USELESS EXCEPTIONS	503
23.5	NUMBER OF EXCEPTIONS	503
24.	APPENDIX D: MULTI-PEER GROUP SYSTEMS	504
24.1	TECHNICAL DETAILS	504
24.1.1	Peer Group Leader.....	504
24.1.2	Border Systems.....	504
24.1.3	Core System in a Very Branchy Network	506
24.1.4	Backbone and Local Area Topology	506

25.	APPENDIX E: ALLOCATING RESOURCES IN TRANSIT PEER GROUPS	508
26.	APPENDIX F: PNNI PACKET SIZES	509
26.1	PNNI HELLO PACKET (PHP)	509
26.2	PNNI TOPOLOGY STATE PACKET (PTSP).....	509
26.3	PTSE ACKNOWLEDGEMENT PACKET (PTSE_AP)	510
26.4	DATABASE SUMMARY PACKET (DBSP).....	511
26.5	PTSE REQUEST PACKET (PTSE_RP)	511
27.	APPENDIX G. FLOODING PARAMETER SELECTION GUIDELINES.....	513
27.1	BASIC PARAMETER RELATIONS	513
27.2	HIGHER HIERARCHICAL LEVELS.....	513
27.3	VARYING THE PEERDELAYEDACKINTERVAL	513
27.4	DEFAULT PEERDELAYEDACKINTERVAL VALUE	513
28.	APPENDIX H: A SAMPLE ALGORITHM FOR ROUTE GENERATION.....	514
29.	APPENDIX I: USING PNNI TO CONNECT NON-PNNI ROUTING DOMAINS.....	521
30.	APPENDICES J TO P	522

List of Figures

<i>Figure 1-1: Switching System Architectural Reference Model</i>	1
<i>Figure 3-1: Private ATM network with 26 switching systems and 33 bi-directional links</i>	13
<i>Figure 3-2: Partially configured PNNI hierarchy showing lowest level nodes.</i>	14
<i>Figure 3-3: Partially configured PNNI hierarchy showing lowest hierarchical levels.</i>	18
<i>Figure 3-4: Uplinks.</i>	20
<i>Figure 3-5: Complex node representation of LGN A.4 from Figure 3-3.</i>	22
<i>Figure 3-6: Example of a complete PNNI hierarchically configured network.</i>	24
<i>Figure 3-7: Uplinks revisited.</i>	25
<i>Figure 3-8: Address summarization in a PNNI hierarchy.</i>	27
<i>Figure 3-9: Sample Network</i>	30
<i>Figure 3-10: View of the network from nodes A.3.3, A.3.2, A.3.1, and A.3.4.</i>	32
<i>Figure 4-1: ATM Interfaces</i>	36
<i>Figure 4-2: A Sample Hierarchical Network</i>	38
<i>Figure 4-3: An Example of Crankback and Alternate Routing</i>	39
<i>Figure 4-4: An Example of Explicitly Routed Call</i>	42
<i>Figure 5-1: NSAP Address Structure and Address Prefixes</i>	45
<i>Figure 5-2: Peer Group Identifier 14 octet encoding</i>	48
<i>Figure 5-3: An SVCC-Based RCC and horizontal links between a Lowest-Level Node and an LGN</i>	57
<i>Figure 5-4: Hello State Changes</i>	62
<i>Figure 5-5: LGN Horizontal Link Hello FSM</i>	76
<i>Figure 5-6: Neighboring Peer State Changes (Database Synchronization)</i>	84
<i>Figure 5-7: PGL Election FSM</i>	116
<i>Figure 5-8: Peer Group with Five Border Nodes</i>	129
<i>Figure 5-9: Default Node Representation</i>	130
<i>Figure 5-10: Complex Node Representation with Exceptions</i>	130
<i>Figure 6-1: PNNI interface</i>	169
<i>Figure 6-1a: Primitives used in the Signalling specification sections</i>	170
<i>Figure 6-2: PNNI Control Plane</i>	171
<i>Figure 6-3: ALERTING Message Contents</i>	175
<i>Figure 6-4: CALL PROCEEDING Message Contents</i>	175
<i>Figure 6-5: CONNECT Message Contents</i>	176
<i>Figure 6-6: RELEASE message content</i>	177
<i>Figure 6-7: RELEASE COMPLETE message content</i>	177
<i>Figure 6-8: SETUP message content</i>	179
<i>Figure 6-9: STATUS message content</i>	180
<i>Figure 6-10: STATUS ENQUIRY message content</i>	180
<i>Figure 6-11: NOTIFY message content</i>	181
<i>Figure 6-11a: CONNECTION AVAILABLE message content</i>	181
<i>Figure 6-12: ALERTING message contents</i>	182
<i>Figure 6-13: CONNECT message contents</i>	183
<i>Figure 6-14: PROGRESS message contents</i>	183
<i>Figure 6-15: RELEASE message content</i>	184
<i>Figure 6-16: SETUP message content</i>	184
<i>Figure 6-17: RESTART message content</i>	185
<i>Figure 6-18: RESTART ACKNOWLEDGE message content</i>	185
<i>Figure 6-19: ADD PARTY message content</i>	187
<i>Figure 6-20: ADD PARTY ACKNOWLEDGE message content</i>	187
<i>Figure 6-21: PARTY ALERTING message content</i>	188
<i>Figure 6-22: ADD PARTY REJECT message content</i>	188
<i>Figure 6-23: DROP PARTY message content</i>	189
<i>Figure 6-24: DROP PARTY ACKNOWLEDGE message content</i>	189
<i>Figure 6-25: Call state information element</i>	196

<i>Figure 6-26: End-to-end transit delay information element</i>	<i>198</i>
<i>Figure 6-27: Calling party Soft PVPC or PVCC Information element.....</i>	<i>202</i>
<i>Figure 6-28: Called party Soft PVPC or PVCC Information element</i>	<i>204</i>
<i>Figure 6-29: Crankback Information element.....</i>	<i>205</i>
<i>Figure 6-30: Designated transit list information element.....</i>	<i>209</i>
<i>Figure 13-1: PNNI Minimum Subsets</i>	<i>267</i>
<i>Figure 21-1 : PNNI Finite State Machine.....</i>	<i>496</i>
<i>Figure 21-2 : Setup, successful call</i>	<i>497</i>
<i>Figure 21-3 : Setup, unsuccessful call</i>	<i>498</i>
<i>Figure 21-4 : Normal call clearing by originator.....</i>	<i>498</i>
<i>Figure 21-5 : Call termination by Network B</i>	<i>499</i>
<i>Figure 24-1: Border Node between Peer Groups A and B</i>	<i>504</i>
<i>Figure 24-2: Two Domains with Individual Border Nodes.....</i>	<i>505</i>
<i>Figure 24-3: Backbone and Local Area Topology.....</i>	<i>506</i>

List of Tables

Table 3-1: Configured Summary Addresses.....	26
Table 3-2: Summary Address List	27
Table 3-3: Advertised Reachable Address Prefixes.....	28
Table 3-4: Advertised Reachability Information	28
Table 5-1: Default UNI Scope to PNNI Level Mappings	51
Table 5-2: AAL Parameters.....	53
Table 5-3: ATM User Cell Rate/ATM Traffic Descriptor.....	53
Table 5-4: Broadband Bearer Capability	54
Table 5-5: Broadband Low Layer Information	54
Table 5-6: QoS Parameter	55
Table 5-7: Extended QoS Parameters.....	55
Table 5-8: Called Party Number (ATM End System Addresses).....	55
Table 5-9: Cause I.E.	56
Table 5-10: Hello FSM.....	66
Table 5-11: Horizontal Link Hello FSM	79
Table 5-12: Neighboring Peer FSM.....	86
Table 5-13: Topology States Parameters.....	93
Table 5-14: PGL Election FSM Part 1.....	120
Table 5-15: PGL Election FSM Part 2.....	121
Table 5-16: PCR and SCR values for CLP=0.....	139
Table 5-17: PCR and SCR values for CLP=0+1	139
Table 5-18: Information Group Summary.....	146
Table 5-18: Information Group Summary continued.....	148
Table 5-19: Information Groups in PNNI Packets.....	149
Table 5-20: The PNNI Packet Header	150
Table 5-21: PNNI Packet Types	150
Table 5-22: The Resource Availability Information Group	151
Table 5-23: RAIG Flags.....	151
Table 5-24: The Uplink Information Attribute	152
Table 5-25: Transit Network ID	152
Table 5-26: Network Identification Data	152
Table 5-27: The PNNI Hello	153
Table 5-28: The Aggregation Token IG	154
Table 5-29: The Nodal Hierarchy List	154
Table 5-30: The LGN Horizontal Link Extension IG	155
Table 5-31: The PTSP Header	156
Table 5-32: The PTSE Header	156
Table 5-33: The Nodal State Parameters IG.....	157
Table 5-34: Flags.....	157
Table 5-35: The Nodal IG	158
Table 5-36: Nodal Flags	158
Table 5-37: The Internal Reachable ATM Address IG.....	159
Table 5-38: The Exterior Reachable ATM Address IG	160
Table 5-39: The Horizontal Links IG	161
Table 5-40: The Uplinks IG.....	161
Table 5-41: The PTSE Acknowledgement Packet	165
Table 5-42: The Database Summary Packet.....	166
Table 5-43: Database Summary Packet Flags.....	166
Table 5-44: The PTSE Request Packet.....	167
Table 5-45: The Systems Capabilities IG.....	168
Table 6-1: Messages for ATM Call and Connection Control.....	174
Table 6-2: Messages for ATM call/ connection control	182

<i>Table 6-3: Messages Used with the Global Call Reference</i>	<i>184</i>
<i>Table 6-4: Messages used with ATM Point-to-multipoint call/connection control.....</i>	<i>186</i>
<i>Table 6-5: Information elements used in PNNI.....</i>	<i>191</i>
<i>Table 13-1: Mandatory and Optional Capabilities.....</i>	<i>267</i>
<i>Table 13-2: Additional Optional PNNI 1.1 Capabilities.....</i>	<i>269</i>
<i>Table 26-1: Contents of PNNI Hello Packet</i>	<i>509</i>
<i>Table 26-2: Contents of PNNI Topology State Packet.....</i>	<i>510</i>
<i>Table 26-3: Contents of PTSE Acknowledgement Packet.....</i>	<i>511</i>
<i>Table 26-4: Contents of Database Summary Packet.....</i>	<i>511</i>
<i>Table 26-5: Contents of PTSE Request Packet</i>	<i>512</i>

1. Introduction

1.1 Overview

This document defines the PNNI protocol for use between private ATM switches, and between groups of private ATM switches. The abbreviation PNNI stands for either Private Network Node Interface or Private Network-to-Network Interface, reflecting these two possible usages. PNNI includes two categories of protocols:

- A protocol is defined for distributing topology information between switches and clusters of switches. This information is used to compute paths through the network. A hierarchy mechanism ensures that this protocol scales well for large world-wide ATM networks. A key feature of the PNNI hierarchy mechanism is its ability to automatically configure itself in networks in which the address structure reflects the topology. PNNI topology and routing is based on the well-known link-state routing technique.
- A second protocol is defined for signalling, that is message flows used to establish point-to-point and point-to-multipoint connections across the ATM network. This protocol is based on the ATM Forum UNI signalling, with mechanisms added to support source routing, crankback, and alternate routing of call setup requests in case of connection setup failure.

Use of this specification by public networks that wish to do so is not precluded.

1.2 Reference Models

The following is the reference model for a Switching System:

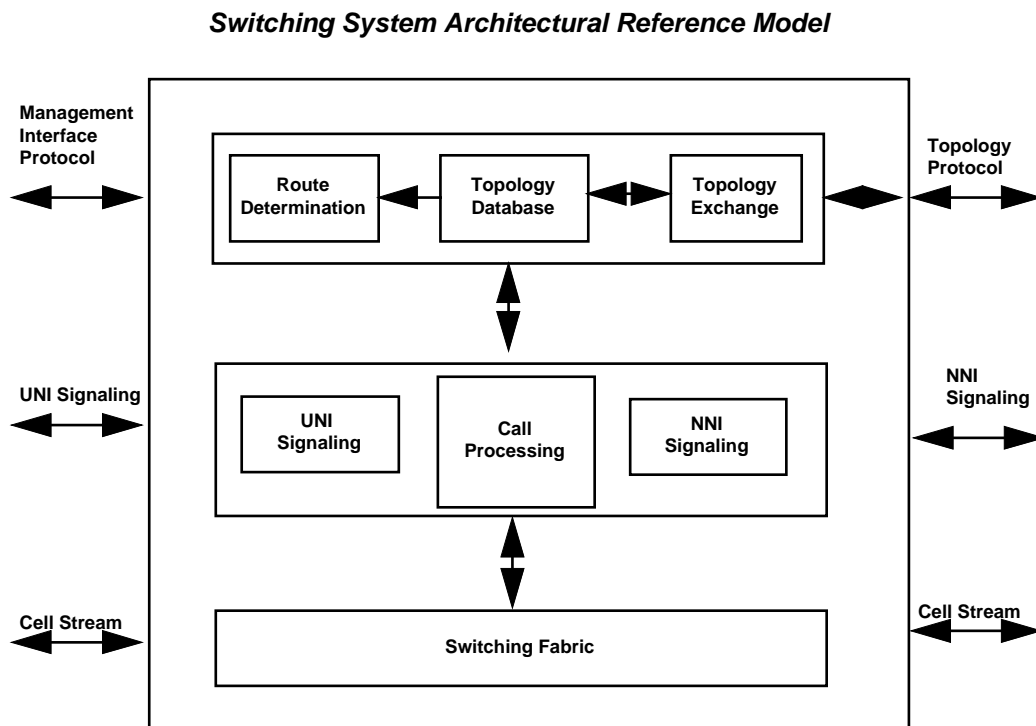

Figure 1-1: Switching System Architectural Reference Model

1.3 PNNI Status³

This document specifies routing and signalling procedures for PNNI 1.1. PNNI 1.1 is designed to be compatible with PNNI 1.0, UNI 3.1, and UNI Signalling 4.0 and 4.1.

~~The current document is a draft version of the Phase 1 PNNI 1.0 specification. PNNI Phase 1.0 is designed to be compatible with the ATM Forum UNI 3.1 specification.~~

Phase 1 of PNNI 1.0 has the following characteristics:

- Supports all UNI 3.1, ~~and some~~ UNI Signalling 4.0 (except Leaf Initiated Join, User to User, Proxy signalling and Virtual UNIs) capabilities.
- Scales to very large networks.
- Supports hierarchical routing.
- Supports QoS.
- Supports multiple routing metrics and attributes.
- Uses source routed connection setup.
- Operates in the presence of partitioned areas.
- Provides dynamic routing, responsive to changes in resource availability.
- Separates the routing protocol used within a peer group from that used among peer groups.
- Interoperates with external routing domains, not necessarily using PNNI.
- Supports both physical links and tunneling over VPCs.
- Supports Soft PVPC/PVCCs.
- Supports anycast.

In addition to errata and text clarifications, PNNI 1.1 adds the following characteristics:³

- Supports all UNI Signalling 4.1 capabilities (except Proxy signalling and Virtual UNIs).
- Explicitly supports multiple administrative domains within a single routing domain.
- Supports enhanced summarization of AESAs with embedded addresses (See Section 5.2.2.1).
- Supports triggering a significant change event for resource availability information on call blocking (See Section 8.5).
- Supports Frame Relay Soft PVC endpoints (as specified in [17]).
- Explicitly supports point to multipoint Soft PVPCs (See Section 9).
- Allows termination of Soft PVCs at non Cell Relay or Frame Relay endpoints (See Section 9).
- Supports enhanced pass along procedures.
- Supports enhanced status enquiry (See Section 18)
- Supports explicitly routed calls (See Section 19).
- Supports the OAM traffic descriptor (See Section 20).

1.4 Document Organization

The PNNI specification is organized into four main sections:

- Chapter 3 includes descriptive text covering the PNNI routing protocol.
- Chapter 4 includes descriptive text covering the PNNI signalling protocol.
- Chapter 5 provides the detailed definition of the PNNI routing protocol.
- Chapter 6 provides the detailed definition of the PNNI signalling protocol.

Annexes are formal clarifications of material in the document, and are part of the specification.

Appendixes are included to help clarify the specification, but are not part of the formal PNNI protocol.

1.5 References³

Only the specific versions of the following referenced documents and the specific versions of the documents referenced within these documents are applicable to this specification.

- [1] af-uni-0010.002, User-Network Interface (UNI) Specification Version 3.1 (September, 1994)
 - [2] af-sig-0061.000, ATM User-Network Interface (UNI) Signalling Specification Version 4.0 (July, 1996)
 - [3] af-pnni-0055.000, Private Network-Network Interface Specification Version 1.0 (PNNI 1.0) (March, 1996)
 - [4] af-sig-0061.002, ATM User-Network Interface (UNI) Signalling Specification Version 4.1 (April, 2002)
 - [5] af-ilmi-0065.000, Integrated Local Management Interface (ILMI) Specification Version 4.0 (September, 1996)
 - [6] af-pnni-0075.000, Addendum to PNNI V1.0 for ABR parameter negotiation (January, 1997)
 - [7] af-pnni-0081.000, PNNI V1.0 Errata and PICS (May, 1997)
 - [8] af-cs-0102.000, PNNI Addendum on PNNI/B-QSIG Interworking and Generic Functional Protocol for the Support of Supplementary Services (October, 1998)
 - [9] af-ra-0104.000, PNNI Augmented Routing (PAR) Version 1.0 (January, 1999)
 - [10] af-ra-0106.000, ATM Forum Addressing: Reference Guide (February 1999)
 - [11] af-cs-0115.000, PNNI Transported Address Stack Version 1.0 (May, 1999)
 - [12] af-cs-116.000, PNNI Version 1.0 Security Signaling Addendum (May, 1999)
 - [13] af-cs-0117.000, UNI Signalling 4.0 Security Addendum (May, 1999)
 - [14] af-tm-0121.000, Traffic Management Specification Version 4.1 (march, 1999)
 - [15] af-ra-0123.000, PNNI Addendum for Mobility Extensions Version 1.0 (May, 1999)
 - [16] af-cs-0126.000, PNNI Addendum for Generic Application Transport Version 1.0 (July, 1999)
 - [17] af-cs-0127.000, PNNI SPVC Addendum Version 1.0 (July, 1999)
 - [18] af-cs-0140.000, Network Call Correlation Identifier v1.0 (March, 2000)
 - [19] af-cs-0141.000, PNNI Addendum For Path and Connection Trace Version 1.0 (March, 2000)
 - [20] af-cs-0147.000, UBR with MDCR Addendum to UNI Signalling 4.0, PNNI 1.0 and AINI (July, 2000)
 - [21] af-cs-0148.001, Modification of Traffic Parameters for an Active Connection Signalling Specification (PNNI, AINI, and UNI), Version 2.0 (May, 2001)
 - [22] af-cs-0159.000, Behavior Class Selector Signalling Version 1.0 (October, 2000)
 - [23] af-cs-0167.000, Guaranteed Frame Rate Signalling Specification (PNNI, AINI, and UNI), Version 1.0 (August, 2001)
 - [24] af-ra-0171.000, Addendum to PNNI 1.0 – Secure Routing (November, 2001)
 - [25] af-cs-0173.000, Domain-based rerouting for active point-to-point calls version 1.0 (August, 2001)
- ATM Forum _____ Traffic Management Specification Version 4.0
ATM Forum _____ User Network Interface Specification Version 3.1
ATM Forum _____ User Network Interface Signalling Specification Version 4.0
ATM Forum _____ ILMI Specification Version 4.0
- [26] IEEE 802-1990, IEEE Standards for Local and Metropolitan Area Networks: Overview and Architecture
 - [27] IETF RFC 1573, "Evolution of the Interface Group of MIB-II", K. McCloghrie and F. Kastenholz, January 1994.

- ~~IETF RFC 1695 "Definitions of Managed Objects for ATM Management Version 8.0 using SMIV2", M. Ahmed and K. Tesink, August 1994.~~
- [28] ~~IETF RFC 2514, "Definitions of Textual Conventions and OBJECT-IDENTITIES for ATM Management", M. Noto, E. Spiegel, K. Tesink, February 1999.~~
- [29] ~~IETF RFC 2515, "Definitions of Managed Objects for ATM Management", K. Tesink, February 1999.~~
- [30] ~~IETF RFC 1902, "Structure of Management Information for Version 2 of the Simple Network Management Protocol (SNMPv2)", SNMPv2 Working Group, January 1996.~~
- [31] ~~IETF RFC 1903, "Textual Conventions for Version 2 of the Simple Network Management Protocol (SNMPv2)", SNMPv2 Working Group, January 1996.~~
- [32] ~~IETF RFC 1904, "Conformance Statements for Version 2 of the Simple Network Management Protocol (SNMPv2)", SNMPv2 Working Group, January 1996.~~
- [33] ~~ITU-T Recommendation I.150 (1993) B-ISDN Asynchronous Transfer Mode Functional Characteristics~~
- [34] ~~ITU-T Recommendation I.361 (1993) B-ISDN ATM Layer Specification~~
- [35] ~~ITU-T Recommendation I.363 (1993) B-ISDN ATM Adaptation Layer (AAL) Specification~~
- [36] ~~ITU-T Recommendation Q.2110 (1994) B-ISDN SAAL-ATM Adaptation Layer Service Specific Connection Oriented Protocol (SSCOP)~~
- [37] ~~ITU-T Recommendation Q.2130 (1994) B-ISDN SAAL Service Specific Coordination Function (SSCF) for Support of Signalling at the User-Network Interface (SCCF at UNI)~~
- [38] ~~ITU-T Recommendation Q.2931 (1995) B-ISDN DSS2 User-Network Interface (UNI) - Layer 3 Specification for Basic Call/Connection Control~~
- [39] ~~ITU-T Recommendation Q.2931 Amendment 2 (03/99) B-ISDN DSS2 User-Network Interface (UNI) - Layer 3 Specification for Basic Call/Connection Control, Amendment 2~~
- [40] ~~ITU-T Recommendation Q.2931 Amendment 2 Corrigendum 1 (2000) B-ISDN DSS2 User-Network Interface (UNI) - Layer 3 Specification for Basic Call/Connection Control, Amendment 2, Corrigendum 1~~
- [41] ~~ITU-T Recommendation Q.2931 Amendment 4 (1999) B-ISDN DSS2 User-Network Interface (UNI) - Layer 3 Specification for Basic Call/Connection Control, Amendment 4~~
- ~~ITU-T Q.2951 (1995) Stage 3 Description for Number Identification Supplementary Services Using B-ISDN DSS2 Basic Call~~
- ~~ITU-T Q.2962 (Note 1) B-ISDN DSS2 Connection Characteristics Negotiation During Establishment Phase~~
- [42] ~~ITU-T Recommendation Q.2971 (Note 1) B-ISDN DSS2 UNI Layer 3 Specification for Point-to-Multipoint Call/Connection Control~~
- [43] ~~ITU-T Recommendation Q.2971 Corrigendum 1 (1999) B-ISDN DSS 2 UNI Layer 3 Specification for point-to-multipoint call/connection control - Corrigendum 1~~
- [44] ~~ITU-T Recommendation X.76 (03/2000) Network-to-network interface between public networks providing PVC and/or SVC frame relay data transmission service~~

~~Note 1: This document is in course of preparation for publication during 1996.~~

~~Only these specific versions of the referenced documents, and the specific versions of the documents referenced from them etc., are included. Other, future, versions of these specifications may also be applicable, as may from time to time be determined by the ATM Forum Technical Committee.~~

2. Terminology

2.1 Abbreviations

AAL	ATM Adaptation Layer
ABR	Available Bit Rate
AESA	ATM End System Address ³
AFI	Authority and Format Identifier
AINI	ATM Inter-Network Interface ³
ASP	ATM Service Provider ³
ATC	ATM Transfer Capability ³
ATM	Asynchronous Transfer Mode
AvCR	Available Cell Rate
AW	Administrative Weight
BGP	Border Gateway Protocol
B-ICI	B-ISDN Inter-Carrier Interface
CAC	Connection Admission Control
CBR	Constant Bit Rate
CDV	Cell Delay Variation
CLP	Cell Loss Priority
CLR	Cell Loss Ratio
CLR ₀	Cell Loss Ratio objective for CLP=0 traffic
CRM	Cell Rate Margin
CTD	Cell Transfer Delay
DSP	Domain Specific Part
DTL	Designated Transit List
ES	End System
ESI	End System Identifier
FSM	Finite State Machine
GCAC	Generic Connection Admission Control
ICR	Initial Cell Rate
IDI	Initial Domain Identifier
IDP	Initial Domain Part
IDRP	Inter Domain Routing Protocol
ILMI	Interim Local Management Interface
IE	Information Element
ID	Identifier
IG	Information Group
LGN	Logical Group Node
LSB	Least Significant Bit
maxCR	Maximum Cell Rate
maxCTD	Maximum Cell Transfer Delay
MBS	Maximum Burst Size
MCR	Minimum Cell Rate
MIB	Management Information Base
MSB	Most Significant Bit
NNI	Network-to-Network Interface
NSAP	Network Service Access Point
OSPF	Open Shortest Path First
PCR	Peak Cell Rate
PG	Peer Group
PGL	Peer Group Leader
PGLE	Peer Group Leader Election
PTSE	PNNI Topology State Element
PTSP	PNNI Topology State Packet

PNNI	Private Network-to-Network Interface
PVC	Permanent Virtual Circuit Connection ³
PVCC	Permanent Virtual Channel Connection
PVPC	Permanent Virtual Path Connection
QoS	Quality of Service
RAIG	Resource Availability Information Group
RCC	Routing Control Channel
RDF	Rate Decrease Factor
RIF	Rate Increase Factor
SAAL	Signalling ATM Adaptation Layer
SCR	Sustainable Cell Rate
SSCOP	Service Specific Connection Oriented Protocol
SSCS	Service Specific Convergence Sublayer
SVC	Switched Virtual Circuit Connection ³
SVCC	Switched Virtual Channel Connection
<u>SVPC</u>	<u>Switched Virtual Path Connection³</u>
TBE	Transit Buffer Exposure
TLV	Type, Length, Value
UBR	Unspecified Bit Rate
ULIA	Uplink Information Attribute
UNI	User to Network Interface
VBR	Variable Bit Rate
VCC	Virtual Channel Connection
VCI	Virtual Channel Identifier
VF	Variance Factor
VP	Virtual Path
VPC	Virtual Path Connection
VPI	Virtual Path Identifier

2.2 Definitions

Address Prefix	A string of 0 or more bits up to a maximum of 152 bits that is the lead portion of one or more ATM addresses.
Adjacency	The relationship between two communicating neighboring peer nodes.
Aggregation Token	A number assigned to an outside link by the border nodes at the ends of the outside link. The same number is associated with all uplinks and induced uplinks associated with the outside link. In the parent and all higher-level peer group, all uplinks with the same aggregation token are aggregated.
Alternate Routing	A mechanism that supports the use of a new path after an attempt to set up a connection along a previously selected path fails.
Ancestor Node	A logical group node that has a direct parent relationship to a given node (i.e., it is the parent of that node, or the parent's parent, ...).
ATM Anycast Capability	The ability to allow an application to request a point-to-point connection to a single ATM end system that is part of an ATM group.
<u>ATM Service Provider Network</u>	<u>Any ATM network that provides transit services for users or other ATM networks belonging to different administrative entities.³</u>
Border Node	A logical node that is in a specified peer group, and has at least one link that crosses the peer group boundary.
Bypass	A bypass represents the connectivity between two ports in the complex node representation. A bypass is always an exception.
Child Node	A node at the next lower level of the hierarchy which is contained in the peer group represented by the logical group node currently referenced. This could be a logical group node, or a physical node.
Child Peer Group	A child peer group of a peer group is any one containing a child node of a logical group node in that peer group. A child peer group of a logical group node is the one containing the child node of that logical group node.
Common Peer Group	The lowest level peer group in which a set of nodes is represented. A node is represented in a peer group either directly or through one of its ancestors.
Complex Node Representation	A collection of nodal state parameters that provide detailed state information associated with a logical node.
Connection Scope	The level of routing hierarchy within which a given connection request to a group address is constrained.
Crankback	A mechanism for partially releasing a connection setup in progress which has encountered a failure. This mechanism allows PNNI to perform alternate routing.
Default Node Representation	A single value for each nodal state parameter giving the presumed value between any entry or exit to the logical node and the nucleus.
Designated Transit List	A list of node and optionally link Ids that completely specify a path across a single PNNI peer group.
Dijkstra's Algorithm	An algorithm that is sometimes used to calculate routes given a link and nodal state topology database.

Domain	Synonymous with PNNI Routing Domain.
DTL Originator	The first lowest-level node within the entire PNNI routing domain to build the initial DTL stack for a given connection.
DTL Terminator	The last lowest-level node within the entire PNNI routing domain to process the connection (and thus the connection's DTL).
End System	A system on which connection termination points are located.
Entry Border Node	The node which receives a call over an outside link. This is the first node within a peer group to see this call.
Exception	A connectivity advertisement in a PNNI complex node representation that represents something other than the default node representation.
Exit Border Node	The node that will progress a call over an outside link. This is the last node within a peer group to see this call.
Exterior	Denotes that an item (e.g., link, node, or reachable address) is outside of a PNNI routing domain.
Exterior Link	A link which crosses the boundary of the PNNI routing domain. The PNNI protocol does not run over an exterior link.
Exterior Reachable Address	An address that can be reached through a PNNI routing domain, but which is not located in that PNNI routing domain.
Exterior Route	A route which traverses an exterior link.
Foreign Address	An address or address prefix that does not match any of a given node's summary addresses.
Hello Packet	A type of PNNI Routing packet that is exchanged between neighboring logical nodes.
Hierarchically Complete Source Route	A stack of DTLs representing a route across a PNNI routing domain such that a DTL is included for each hierarchical level between and including the current level and the lowest visible level in which the source and destination are reachable.
Hop by Hop Route	A route that is created by having each switch along the path use its own routing knowledge to determine the next hop of the route, with the expectation that all switches will choose consistent hops such that the call will reach the desired destination. PNNI does not use hop-by-hop routing.
Horizontal Link	A link between two logical nodes that belong to the same peer group.
Induced Uplink	An uplink "A" that is created due to the existence of an uplink "B" in the child peer group represented by the node that created uplink "A". Both "A" and "B" share the same upnode, which is higher in the PNNI hierarchy than the peer group in which uplink "A" is seen.
Inside Link	Synonymous with horizontal link.
Instance ID	A subset of an object's attributes which serve to uniquely identify a MIB instance.
Interior	Denotes that an item (e.g., link, node, or reachable address) is inside of a PNNI routing domain.
Internal Reachable Address	An address of a destination that is directly attached to the logical node advertising the address.

Leadership Priority	The priority with which a logical node wishes to be elected peer group leader of its peer group. Generally, of all nodes in a peer group, the one with the highest leadership priority will be elected as peer group leader.
Level	Level is the position in the PNNI hierarchy at which a particular node or peer group exists. A level that has a smaller numerical value implies greater topology aggregation, and is hence called a 'higher level' in the PNNI hierarchy throughout this document. Conversely, a level that has a larger numerical value implies less topology aggregation, and is hence called a 'lower level' in the PNNI hierarchy throughout this document.
Link	Synonymous with logical link.
Link Aggregation Token	See Aggregation Token.
Link Attribute	A link state parameter that is considered individually to determine whether a given link is acceptable and/or desirable for carrying a given connection.
Link Constraint	A restriction on the use of links for path selection for a specific connection.
Link Metric	A link parameter that requires the values of the parameter for all links along a given path to be combined to determine whether the path is acceptable and/or desirable for carrying a given connection.
Link State Parameter	Information that captures an aspect or property of a link.
Logical Group Node	An abstract representation of a lower level peer group as a single point for purposes of operating at one level of the PNNI routing hierarchy.
Logical Link	An abstract representation of the connectivity between two logical nodes. This includes individual physical links, individual virtual path connections, and parallel physical links and/or virtual path connections.
Logical Node	A lowest-level node or a logical group node.
Logical Node ID	A string of bits that unambiguously identifies a logical node within a routing domain.
Lowest Level Node	A leaf in the PNNI routing hierarchy; an abstraction representing a single instance of the PNNI routing protocol. Lowest-level nodes are created in a switching system via configuration. They are not created dynamically.
Membership Scope	The level of routing hierarchy within which advertisement of a given address is constrained.
MIB Attribute	A single piece of configuration, management, or statistical information which pertains to a specific part of the PNNI protocol operation.
MIB Instance	An incarnation of a MIB object that applies to a specific part, piece, or aspect of the PNNI protocol's operation.
MIB Object	A collection of attributes that can be used to configure, manage, or analyze an aspect of the PNNI protocol's operation.
Native Address	An address or address prefix that matches one of a given node's summary addresses.
Neighbor Node	A node that is directly connected to a particular node via a logical link.
Network Management Entity (NM)	The body of software in a switching system that provides the ability to manage the PNNI protocol. NM interacts with the PNNI protocol through the MIB.
Nodal Attribute	A nodal state parameter that is considered individually to determine whether a given node is acceptable and/or desirable for carrying a given connection.

Nodal Constraint	A restriction on the use of nodes for path selection for a specific connection.
Nodal Metric	A nodal parameter that requires the values of the parameter for all nodes along a given path to be combined to determine whether the path is acceptable and/or desirable for carrying a given connection.
Nodal State Parameter	Information that captures an aspect or property of a node.
Node	Synonymous with logical node.
Non-Branching Node	A node that cannot currently support additional branching points for point-to-multipoint calls.
Nucleus	The interior reference point of a logical node in the PNNI complex node representation.
Null	A value of all zeros.
Outlier	A node whose exclusion from its containing peer group would significantly improve the accuracy and simplicity of the aggregation of the remainder of the peer group topology.
Outside Link	A link to a lowest-level outside node. In contrast to an inside link (i.e., horizontal link) or an uplink, an outside link does not form part of the PNNI topology, and is therefore not used in path computation.
Outside Node	A node which is participating in PNNI routing, but which is not a member of a particular peer group.
Parent Node	The logical group node that represents the containing peer group of a specific node at the next higher level of the hierarchy.
Parent Peer Group	The parent peer group of a peer group is the one containing the logical group node representing that peer group. The parent peer group of a node is the one containing the parent node of that node.
Path Constraint	A bound on the combined value of a topology metric along a path for a specific connection.
Path Scope	The highest level of PNNI hierarchy used by a path.
Peer Group	A set of logical nodes which are grouped for purposes of creating a routing hierarchy. PTSEs are exchanged among all members of the group.
Peer Group Identifier	A string of bits that is used to unambiguously identify a peer group.
Peer Group Leader	A node of a peer group that performs the extra work of collecting, aggregating, and building data that will be suitable to represent the entire peer group as a single node. This representation is made available in the parent node.
Peer Group Level	The number of significant bits in the peer group identifier of a particular peer group.
Peer Node	A node that is a member of the same peer group as a given node.
Physical Link	A real link which attaches two switching systems.
PNNI Protocol Entity	The body of software in a switching system that executes the PNNI protocol and provides the routing service.
PNNI Routing Control Channel	VCCs used for the exchange of PNNI routing protocol messages.
PNNI Routing Domain	A group of topologically contiguous systems which are running one instance of PNNI routing.

PNNI Routing Hierarchy	The hierarchy of peer groups used for PNNI routing.
PNNI Topology State Element	A collection of PNNI information that is flooded among all logical nodes within a peer group.
PNNI Topology State Packet	A type of PNNI Routing packet that is used for flooding PTSEs among logical nodes within a peer group.
Port	The point of attachment of a link to a node.
Port Identifier	The identifier assigned by a logical node to represent the point of attachment of a link to that node.
Private ATM Address	A twenty octet address used to identify an ATM connection termination point.³
Reachable Address Prefix	A prefix on a 20 octet ATM address indicating that all addresses beginning with this prefix are reachable.
Read-Only (RO)	Attributes which are read-only can not be written by Network Management. Only the PNNI Protocol entity may change the value of a read-only attribute. Network Management entities are restricted to only reading such read-only attributes. Read-only attributes are typically for statistical information, including reporting result of actions taken by auto-configuration.
Read-Write (RW)	Attributes which are read-write can not be written by the PNNI protocol entity. Only the Network Management Entity may change the value of a read-write attribute. The PNNI Protocol Entity is restricted to only reading such read-write attributes. Read-write attributes are typically used to provide the ability for Network Management to configure, control, and manage a PNNI Protocol Entity's behavior.
Restricted Transit Node	A node that is to be used for transit by a call only in restricted circumstances. It is free from such restriction when it is used to originate or terminate a call.
Routing Computation	The process of applying a mathematical algorithm to a topology database to compute routes. There are many types of routing computations that may be used. The Dijkstra algorithm is one particular example of a possible routing computation.
Routing Constraint	A generic term that refers to either a topology constraint or a path constraint.
Scope	A scope defines the level of advertisement for an address. The level is a level of a peer group in the PNNI routing hierarchy.
Source Route	As used in this document, a hierarchically complete source route.
Split System	A switching system which implements the functions of more than one logical node.
Spoke	In the complex node representation, this represents the connectivity between the nucleus and a specific port.
Summary Address	An address prefix that tells a node how to summarize reachability information.
Switching System	A set of one or more physical devices that act together as a single PNNI network management entity. A switching system contains one or more lowest-level nodes and, when it is acting as a PGL, one or more LGNs.
Topology State Parameter	A generic term that refers to either a link parameter or a nodal parameter.
Topology Aggregation	The process of summarizing and compressing topology information at a hierarchical level to be advertised at the level above.
Topology Attribute	A generic term that refers to either a link attribute or a nodal attribute.

Topology Constraint	A topology constraint is a generic term that refers to either a link constraint or a nodal constraint.
Topology Database	The database that describes the topology of the entire PNNI routing domain as seen by a node.
Topology Metric	A generic term that refers to either a link metric or a nodal metric.
Uplink	Represents the connectivity from a border node to an upnode.
Upnode	The node that represents a border node's outside neighbor in the common peer group. The upnode must be a neighboring peer of one of the border node's ancestors.

2.3 Notation and Conventions

<i>string</i>	A dot delimited string such as "A.2.3.1" represents a node ID or a peer group ID.
< <i>string</i> >	A string enclosed in brackets "<>" represents an ATM address. Specifically, it is the address of the entity identified by the string.
P< <i>string</i> >	A string enclosed by the notation "P<>" represents a prefix of an ATM address.
PG(<i>string</i>)	A string enclosed by the notation "PG()" represents a peer group ID

3. PNNI Routing Description

In this chapter an introduction to PNNI routing is provided. A detailed definition of the protocols is given in Chapter 5. In case of discrepancies, the material in Chapter 5 has precedence over this chapter.

The functions of the PNNI routing protocol include:

- Discovery of neighbors and link status.
- Synchronization of topology databases.
- Flooding of PTSEs.
- Election of PGLs.
- Summarization of topology state information.
- Construction of the routing hierarchy.

The remainder of this chapter provides a bottom up description of the PNNI routing protocol.

3.1 Physical Network

PNNI routing applies to a network of lowest-level nodes. Figure 3-1 illustrates such a network, consisting of 26 interconnected lowest-level nodes shown as small circles.

Data passes through lowest-level nodes to other lowest-level nodes and to end systems. End systems are points of origin and termination of connections. End systems are not shown in Figure 3-1. For purposes of route determination, end systems are identified by the 19 most significant octets of ATM End System Addresses. The selector octet (the last octet) is not used for purposes of PNNI route determination but may be used by end systems.

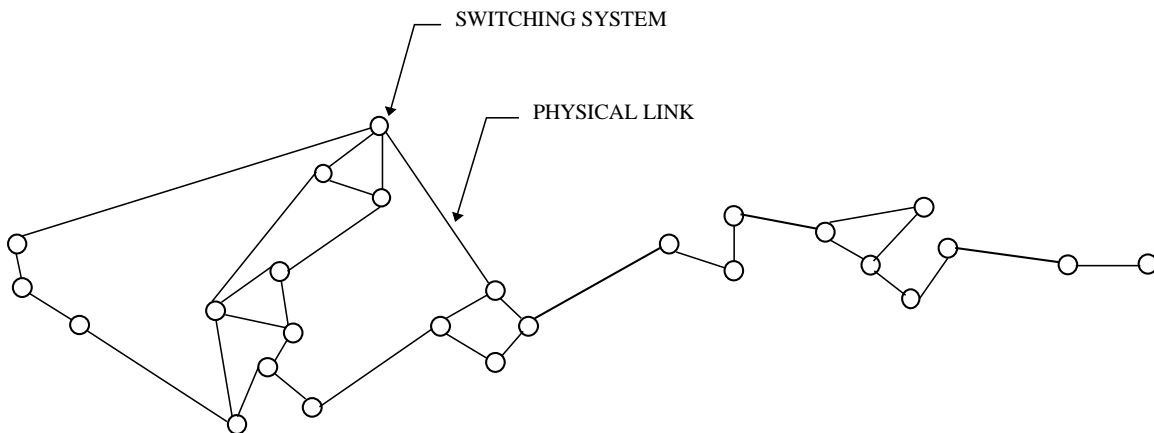

Figure 3-1: Private ATM network with 26 switching systems and 33 bi-directional links.

Each arc in Figure 3-1 represents a “physical link” attaching two switching systems. A port is the attachment point of a link to a lowest-level node within a switching system. Physical links are duplex (traffic may be carried in either direction). However, physical link characteristics may be different in each direction, either because the capacities are different or because existing traffic loads differ. Each physical link is therefore identified by two sets of parameters, one for each direction. Such a set consists of a transmitting port Identifier plus the node ID of the lowest-level node containing that port. Note that PNNI port IDs (as described in Section 5.3.4) may be different from equipment specific port identifiers.

3.2 The Lowest Hierarchical Level

If the PNNI protocol supported only the flat network representation depicted in Figure 3-1, then each lowest-level node would have to maintain the entire topology of the network, including information for every physical link in the network and reachability information for every node in the network. Although feasible for small networks, this would create enormous overhead for larger networks. The PNNI routing hierarchy is designed to reduce this overhead while providing for efficient routing.

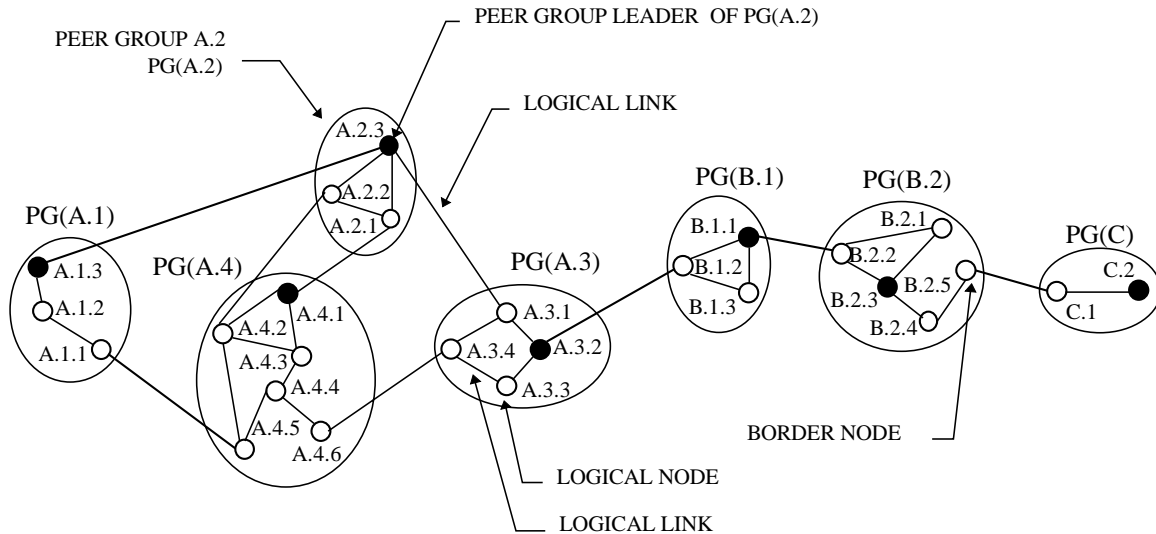

Figure 3-2: Partially configured PNNI hierarchy showing lowest level nodes.

This section begins with the description of the PNNI routing hierarchy by focusing on the lowest hierarchical level. Note that partial connectivity does exist before the entire PNNI routing hierarchy has been established; the entire PNNI routing hierarchy must be present before full connectivity between all nodes is achieved.

3.2.1 Peer Groups and Logical Nodes

The PNNI hierarchy begins at the lowest level where the lowest-level nodes are organized into peer groups. A “logical node” in the context of the lowest hierarchy level is a lowest-level node. For simplicity, logical nodes are often denoted as “nodes”. A peer group (PG) is a collection of logical nodes, each of which exchanges information with other members of the group, such that all members maintain an identical view of the group. Logical nodes are uniquely and unambiguously identified by “logical node IDs”.

In the example (see Figure 3-2) the network is organized into 7 peer groups A.1, A.2, A.3, A.4, B.1, B.2, and C. To avoid later confusion between nodes and peer groups, peer groups are represented in the figures by PG(). For example PG(A.3) denotes peer group A.3. Node and peer group numbering, such as A.3.2 and A.3, is for identification purposes when reading this document. It is an abstract representation that reflects the hierarchical structure being described. For example the node denoted by A.3.2 is located in PG(A.3), i.e. in peer group A.3.

A peer group is identified by its “peer group identifier”. Peer group IDs are specified at configuration time. Neighboring nodes exchange peer group IDs in “Hello packets” (see Section 5.6 for more information on the Hello protocol). If they have the same peer group ID then they belong to the same peer group. If the exchanged peer group IDs are different, then the nodes belong to different peer groups.

A “border node” has at least one link that crosses the peer group boundary. Hence neighboring nodes with different peer group IDs are border nodes of their respective peer groups. In the presence of certain errors or failures, peer groups can partition, leading to the formation of multiple peer groups with the same peer group ID.

The peer group ID is defined as a prefix of at most 13 octets on an ATM End System Address. Thus the peer group ID can default to a prefix on the address(s) of one or more nodes belonging to the peer group in question, but this is not a requirement.

3.2.2 Logical Links And Their Initialization

Logical nodes are connected by “logical links”. Between lowest level nodes, a logical link is either a physical link (such as those shown in Figure 3-1) or a VPC between two lowest-level nodes. Links between lowest level nodes in the same peer group are not aggregated. For example if two physical links were to connect the same pair of lowest-level nodes in Figure 3-1 then they would be represented by two separate logical links in Figure 3-2. Logical links inside a peer group are “horizontal links” whereas links that connect two peer groups are “outside links”.

When a logical link becomes operational, the attached nodes initiate an exchange of information via a well-known VCC used as a “PNNI Routing Control Channel” (RCC). Hello packets sent periodically by each node on this link specify the ATM End System Address, node ID, and its port ID for the link. In this way the Hello protocol makes the two neighboring nodes known to each other. As already mentioned, the PNNI Hello protocol also supports the exchange of peer group IDs so that neighboring nodes can determine whether they belong to a same peer group or to different peer groups.

The Hello protocol runs as long as the link is operational. It can therefore act as a link failure detector when other mechanisms fail.

3.2.3 Information Exchange in PNNI

Each node exchanges Hello packets with its immediate neighbors and thereby determines its local state information. This state information includes the identity and peer group membership of the node’s immediate neighbors, and the status of its links to the neighbors. Each node then bundles its state information in “PNNI Topology State Elements” (PTSEs), which are reliably flooded throughout the peer group.

PTSEs are the smallest collection of PNNI routing information that is flooded as a unit among all logical nodes within a peer group. A node’s topology database consists of a collection of all PTSEs received, which represent that node’s present view of the PNNI routing domain. In particular the topology database provides all the information required to compute a route from the given node to any address reachable in or through that routing domain.

3.2.3.1 Nodal Information

Every node generates a PTSE that describes its own identity and capabilities, information used to elect the peer group leader (see Section 3.2.4), as well as information used in establishing the PNNI hierarchy (see Section 3.3.1). This is referred to as the nodal information.

3.2.3.2 Topology State Information

PTSEs contain, among other things, “topology state parameters” (i.e. “link state parameters”, which describe the characteristics of logical links, and “nodal state parameters”, which describe the characteristics of nodes).

Topology state parameters are classified as either attributes or metrics. An attribute is considered individually when making routing decisions. For example a security “nodal attribute” could cause a given path to be refused. A metric on the other hand is a parameter whose effect is cumulative along a path. For example, delay “metrics” add up as one progresses along a given path. See Section 5.8 for more details.

Certain topology state information, especially that related to bandwidth, is rather dynamic. On the other hand, other topology state information, such as Administrative Weight, may be relatively static. There is no distinction between dynamic and static topology state parameters in the flooding mechanism for PNNI topology distribution.

3.2.3.3 Reachability Information

Reachability information consists of addresses and address prefixes which describe the destinations to which calls may be routed. This information is advertised in PTSEs by nodes in the PNNI routing domain.

Internal and exterior reachability information is logically distinguished based on its source. PNNI routing may not be the only protocol used for routing in an ATM network. Exterior reachability is derived from other protocol exchanges outside this PNNI routing domain. Internal reachability represents local knowledge of reachability within the PNNI routing domain. The primary significance of this distinction is that exterior reachability information shall not be advertised to other routing protocols or routing domains (for fear of causing routing loops across routing domains). Manual configuration can be used to create internal or exterior reachability information with corresponding effects on what is advertised to other routing protocols or domains.

Exterior reachable addresses may also be used to advertise connectivity to otherwise independent PNNI routing domains.

3.2.3.4 Initial Topology Database Exchange

When neighboring nodes, at either end of a logical link being initialized through the exchange of Hellos, conclude that they are in the same peer group, they proceed to synchronize their “topology databases”. Database synchronization is the exchange of information between neighbor nodes resulting in the two nodes having identical topology databases. The topology database includes detailed topology information about the peer group in which the logical node resides plus more abstract topology information representing the remainder of the PNNI routing domain. The way in which this higher level information flows into the peer group is described in subsequent Sections 3.3 to 3.5.

During a topology database synchronization, the nodes in question first exchange PTSE header information, i.e. they advertise the presence of PTSEs in their respective topology database. When a node receives PTSE header information that advertises a more recent PTSE version than the one it has or advertises a PTSE that it does not yet have, it requests the advertised PTSE and updates its topology database with the subsequently received PTSE. If a newly initialized node connects to a peer group then the ensuing database synchronization reduces to a one way topology database copy.

A link is advertised via PTSE transmissions only after the database synchronization between the respective neighboring nodes has successfully completed. In this way the link state parameters are distributed to all topology databases in the peer group containing that link. As we shall see in the following section, flooding is the mechanism used for advertising links.

3.2.3.5 Flooding

Flooding is the reliable hop-by-hop propagation of PTSEs throughout a peer group. It ensures that each node in a peer group maintains an identical topology database (Section 5.8.3). Flooding is the advertising mechanism in PNNI.

In essence, the flooding procedure is as follows. PTSEs are encapsulated within “PNNI topology state packets” (PTSPs) for transmission. When a PTSP is received its component PTSEs are examined. Each PTSE is acknowledged by encapsulating information from its PTSE header within an “Acknowledgment Packet”, which is sent back to the sending neighbor. If the PTSE is new or of more recent origin than the node’s current copy, it is installed in the topology database and flooded to all neighbor nodes except the one from which the PTSE was received. A PTSE sent to a neighbor is periodically retransmitted until acknowledged.

Flooding is an ongoing activity, i.e. each node issues PTSPs with PTSEs that contain updated information. The PTSEs contained in topology databases are subject to aging and get removed after a predefined duration if they are not refreshed by new incoming PTSEs. Only the node that originally originates a particular PTSE can reoriginate that PTSE. PTSEs are reissued both periodically and on an event driven basis.

3.2.4 Peer Group Leader

Section 3.3 describes how a peer group is represented in the next hierarchical level by a single node called a “logical group node”. The functions needed to perform this role are executed by a node, called the “peer group leader”, that is a member of the peer group being represented. There is at most one active peer group leader (PGL) per peer group; more precisely at most one per partition in the case of a partitioned peer group.

Apart from its specific role in aggregation and distribution of information for maintaining the PNNI hierarchy, the PGL does not have any special role in the peer group. For all other functions, e.g., connection establishment, it acts like any other node.

A “peer group leader election” (PGL) process determines which node takes on this leader function. The criterion for election is a node’s “leadership priority”. The node with highest leadership priority in a peer group becomes leader of that peer group. Note that the election process is a continuously running protocol. When a node becomes active with a leadership priority higher than that of the current PGL, the election process transfers peer group leadership to the newly activated node. When a PGL is removed or fails, the node with the next highest leadership priority becomes PGL. Finally, if a race condition between multiple nodes with identical leadership priority occurs then that node with the highest node ID becomes PGL. Note that when a node is elected PGL, its leadership priority is increased to ensure stability.

Internal operation of a peer group does not require having a peer group leader. Full connectivity within a peer group can be achieved without a peer group leader. A PNNI Routing Domain configured as a single peer group can achieve full connectivity even without a peer group leader.

A degenerate form of a peer group is one containing a single node. The peer group leader of a single node peer group is the node itself. This could occur through configuration, or as a result of failures.

3.3 One Hierarchical Level Up

This section describes how peer groups are represented in the next hierarchical level.

3.3.1 Logical Group Nodes

A “logical group node” is an abstraction of a peer group for the purpose of representing that peer group in the next PNNI routing hierarchy level. For example, in Figure 3-3, logical group node A.2 represents peer group A.2 in the next higher level peer group A. Figure 3-3 shows one way that the peer groups in Figure 3-2 can be organized into the next level of peer group hierarchy.

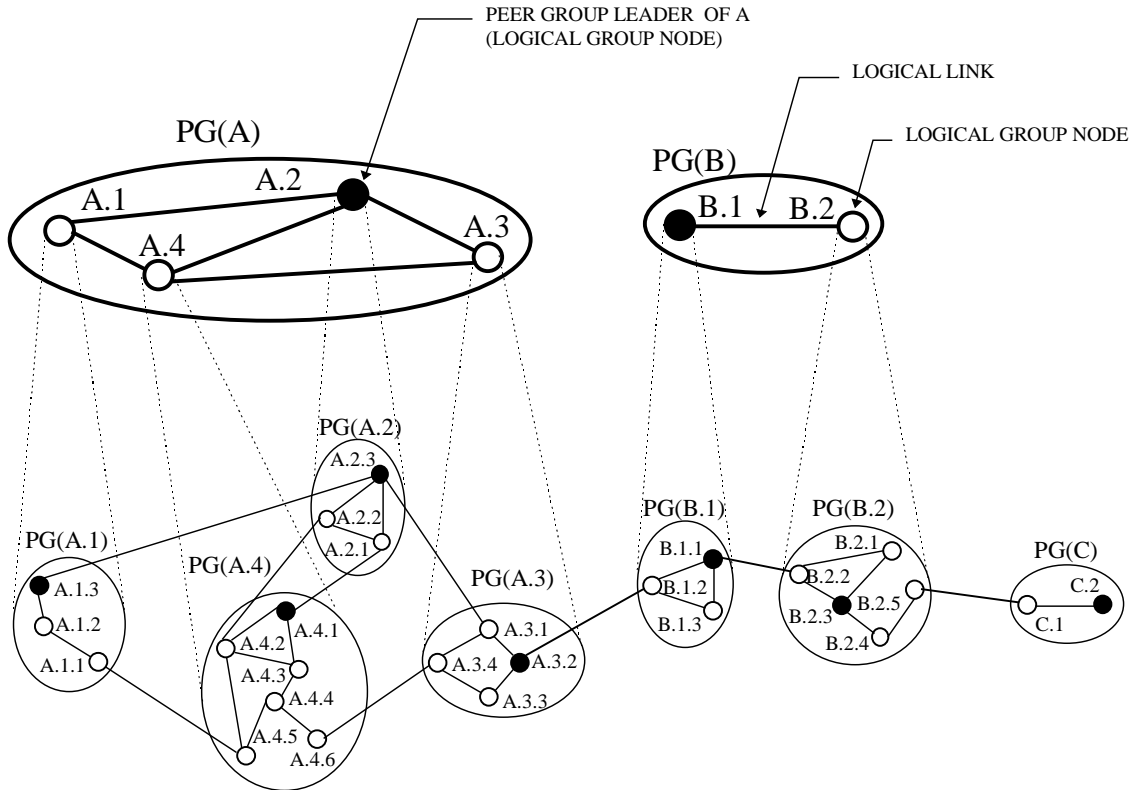

Figure 3-3: Partially configured PNNI hierarchy showing lowest hierarchical levels.

The functions of the logical group node and the peer group leader of its child peer group are closely related. In this specification the functions of these two nodes are considered to be executed in the same system. Therefore, the interface between those two components is not specified.

The functions of a logical group node include aggregating and summarizing information about its child peer group and flooding that information into its own peer group. A logical group node also passes information received from its peer group to the PGL of its child peer group for flooding. A logical group node does not participate in PNNI signalling.

A logical group node is identified by a node ID which by default contains the peer group ID of the peer group that the node is representing.

A logical group node is addressable by a unique ATM End System Address that may, for example, correspond to the address of the lowest-level node in the same switching system but with a different Selector value.

The manner in which a peer group is represented depends on the policies and algorithms of the peer group leader. Thus given two potential peer group leaders that implement the same policies and algorithms, the representation of the peer group does not depend on which of the two is elected.

Observe that logical group nodes in Figure 3-3 are organized into peer groups. For example, logical nodes A.1, A.2, A.3 and A.4 are organized into peer group A. This higher level peer group is a peer group in the sense of Section 3.2, the only difference being that each of its nodes represents a separate lower level peer group. Consequently, peer group A has a peer group leader (logical group node A.2) chosen by the leader election process. Note the functions that define peer group leader of A are located in node A.2, which is in turn implemented on the switching system containing lowest-level node A.2.3.

Peer group A is called the “parent peer group” of peer groups A.1, A.2, A.3 and A.4. Conversely, peer groups A.1, A.2, A.3 and A.4 are called “child peer groups” of peer group A.

A parent peer group is identified by a peer group ID that must be shorter in length than its child peer group IDs. Any node capable of becoming peer group leader must be configured with its parent peer group ID.

The length of a peer group ID indicates the level of that peer group within the PNNI hierarchy. One refers to this length as the “level indicator”. PNNI levels are not dense, in the sense that not all levels will be used in any specific topology. For example a peer group with an ID of length "n" bits may have a parent peer group whose ID ranges anywhere from 0 to n-1 bits in length. Similarly, a peer group with an ID of length "m" bits may have a child peer group whose identifier ranges anywhere from m+1 to 104 bits in length (104 is the maximum peer group ID length and corresponds to 13 octets).

3.3.2 Feeding Information Up The Hierarchy

A logical group node represents an entire underlying peer group. The associated peer group leader, as a member of the underlying peer group, has received complete topology state information from all nodes in the peer group. This provides the peer group leader with all of the required information to instantiate the logical group node. Conceptually this may be thought of as the peer group leader feeding information up to the logical group node it instantiates. This upward flow includes two types of information: reachability and topology aggregation. Reachability refers to summarized address information (see Section 3.5) needed to determine which addresses can be reached through the lower level peer group. Topology aggregation refers to the summarized topology information (see Section 3.3.8) needed to route into and across this peer group.

There is a filtering function inherent in the summarization process that propagates only the information needed by the higher levels. PTSEs never flow up the hierarchy. Instead the summarized information is advertised within PTSEs originated by the logical group node and flooded to its peers.

3.3.3 Feeding Information Down The Hierarchy

Section 3.3.2 described how feeding information up the PNNI routing hierarchy is necessary for creating the hierarchy itself and for distributing routing information about child peer groups. Conversely feeding information down the hierarchy is necessary to allow nodes in the lower level peer groups to route to all destinations reachable via the PNNI routing domain. Route computation uses this information to select routes to destinations.

Each logical group node feeds information down to its underlying peer group. The information fed down consists of the PTSEs it originates and all PTSEs it ~~originates or~~³receives via flooding from other members of the LGN's peer group. Each PTSE that flows down to a peer group leader is flooded across that peer group. This gives every node in a peer group a view of the higher levels into which it is being aggregated. In summary, PTSEs flow horizontally through a peer group and downward into and through child peer groups.

3.3.4 Uplinks (Revisiting The Hello Protocol)

When neighbor nodes conclude from the Hello protocol that they belong to different peer groups, they become border nodes. For example nodes A.3.4 and A.4.6 are border nodes in Figure 3-4. Links between border nodes in different peer groups are called outside links. There is no database exchange across outside links; the only PNNI protocol flows are for the Hello protocol.

Border nodes extend the Hello protocol across outside links to include information (the nodal hierarchy list) about their respective higher level peer groups, and the logical group nodes representing them in these peer groups. This information allows the border nodes to determine the lowest level peer group common to both border nodes. For example in Figure 3-4, the border nodes A.3.4 and A.4.6 identify that they have peer group A in common.

The mechanisms described above allow each node to know the complete topology (including nodes and links) within its peer group, as well as the complete (summarized) topology of the higher level parent peer group, and grand-parent peer group etc. In order for the node to realize which (border) nodes have connectivity to which higher level nodes, the border nodes must advertise links to those higher level nodes. These are called uplinks. The node at the other end of the uplink, the upnode, is always a neighboring peer of one of its ancestor nodes (in the two-level case depicted in Figure 3-4, a neighboring peer of its parent node).

For certain Hello states, a border node must include an Uplink Information Attribute (ULIA) information group in the Hello packets its sends on each outside link to neighboring border nodes. The ULIA sent to an outside neighbor encloses a complete set of information about the reverse direction resources to be advertised in the uplink advertisement that the receiving outside neighbor generates.

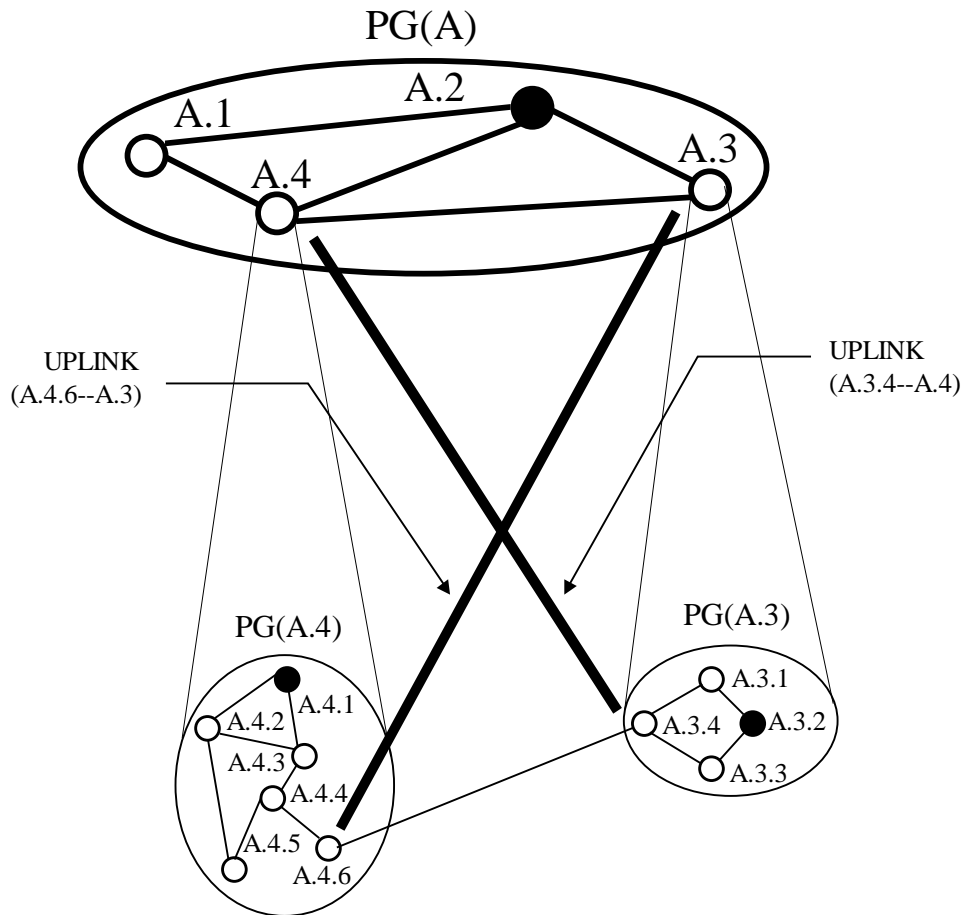

Figure 3-4: Uplinks.

The nodal hierarchy list provides the border nodes with the information necessary for them to determine their common higher level peer groups, and to identify the higher level nodes to which the border nodes will declare connectivity. For example in Figure 3-4, border node A.3.4 recognizes that its neighbor A.4.6 is represented by logical group node A.4 in the common parent peer group A. Consequently A.3.4 advertises an uplink between itself and upnode A.4. The uplink is denoted by (A.3.4--A.4). Similarly node A.4.6 has an uplink (A.4.6--A.3) to the remote higher level node (or upnode) A.3.

Border nodes advertise their uplinks in PTSEs flooded in their respective peer groups. This enables all nodes in the peer group to update their topology databases with the uplinks. It also gives the peer group leaders reachability information that must be fed up the hierarchy since uplinks help create the higher level peer group.

Topology state parameters for both directions of an uplink are included in the uplink PTSE since the upnode does not advertise a PTSE for the downward direction. Topology state parameters for the reverse direction of the uplink are exchanged in Hello packets on the outside link.

3.3.5 PNNI Routing Control Channels

Neighboring PNNI nodes have a routing control channel for the exchange of PNNI routing information. Neighboring nodes at their lowest level of the PNNI routing hierarchy use a reserved VCC for their routing control channel. The routing control channel between logical group nodes is an SVCC. The information required to establish this SVCC is derived from the uplink advertisements in the peer group represented by the logical group node.

For example, to establish the RCC between A.3 and A.4 the following steps are taken. Peer group leader A.3.2 receives the PTSE describing the uplink (A.3.4--A.4) flooded by A.3.4. A.3.2 extracts two key pieces of information from this PTSE, the ID of the common peer group that was previously identified as peer group A by the Hello protocol executing across (A.3.4--A.4.6), and the ATM End System Address of upnode A.4. Node A.3.2 passes this information to its logical group node A.3. From this information, A.3 deduces that it belongs to the same peer group as A.4. It also deduces that A.4 is a neighbor and it therefore needs to have an RCC to A.4.

Since A.3 has the ATM End System Address used to reach A.4, it has sufficient information to set up the SVCC. Similarly logical group node A.4 has enough information to set up the SVCC to A.3. Note that the protocol ensures that only one of them will initiate the SVCC establishment.

Note that at the time the SVCC for the RCC is being established, the nodes in both neighboring peer groups have all information required to route the SVCC. In particular, each peer group has its own internal topology information and knows of the existence and identity of uplinks and upnodes relevant to the routing of the SVCC-based RCC.

3.3.6 Revisiting Initial Topology Database Exchange

Logical group nodes at higher levels have behaviors similar to those of lower level nodes. For example, in Figure 3-3 when the SVCC-based RCC is established between nodes A.3 and A.4, the Hello protocol is activated across it. When A.3 and A.4 confirm that they are in the same peer group they will execute an initial topology database exchange across the RCC. Note A.3 and A.4 already know they belong to a same peer group otherwise they would not have set-up the RCC; the Hello protocol simply confirms the association.

The initial topology database exchange between logical group nodes A.3 and A.4 will synchronize the databases of these two nodes. Note that information specific to the child peer groups of A.3 and A.4 is not part of these databases. Thus the initial topology database exchange between nodes A.3 and A.4 only includes the PTSEs flooded in peer group A. Since PTSEs flow horizontally and downwards (Section 3.3.3), the database exchange will also include PTSEs fed into peer group A by A.2, the peer group leader of A. This assumes that the peer group leader of A exists before link (A.3--A.4) comes up. If that is not the case, no higher-level information will be available in the peer group at that time.

3.3.7 Horizontal Links

Horizontal links are logical links between nodes in the same peer group. Thus not only is (A.3.4--A.3.3) a horizontal link but (A.3--A.4) is also one (see Figure 3-4). This latter horizontal link is in the higher level peer group A and is created as a consequence of the uplinks derived in Section 3.3.4. Hellos are sent to the neighbor LGN over the SVCC-based RCC to exchange port IDs and status for horizontal links.

Horizontal links are not advertised until a successful exchange of Hellos and completion of database synchronization has occurred between neighboring nodes over the RCC. PTSEs describing the new link can now be flooded within the peer group containing the link, i.e. within peer group A, and downwards to the child peer groups.

A horizontal link between a pair of LGNs represents the connectivity between those two nodes for routing purposes. Logical group nodes are responsible for assigning port IDs to horizontal links, as well as other links attached to the node.

3.3.8 Topology Aggregation

Topology aggregation is the notion of reducing nodal as well as link information to achieve scaling in a large network. It is not only motivated by the need for complexity reduction but also to hide the topology internals of peer groups in the interest of security.

3.3.8.1 Link Aggregation

Link aggregation refers to the representation of some set of links between the same two peer groups by a single logical link (see Section 5.10.3.1). For example in Figure 3-3, the link connecting node A.2 to A.4 represents the aggregation of the two links (A.2.1--A.4.1), and (A.2.2--A.4.2).

Logical group nodes are responsible for link aggregation. A logical group node examines all of the uplink advertisements from its child peer group to a specific upnode. All uplinks to the same upnode with the same aggregation token, as the result of configuration, are aggregated into a single link. This link could be either a horizontal link, if the upnode is a peer of the logical group node, or an induced uplink otherwise (see Section 3.4.2).

3.3.8.2 Nodal Aggregation

Nodal aggregation is the process of representing a child peer group by a logical group node in its parent peer group.

The “complex node representation” is used to represent the result of this aggregation in the parent peer group. It is also permissible to use the complex node representation to model a lowest-level node.

The simplest complex node representation is a symmetric star topology with a uniform radius. The center of the star is the interior reference point of the logical node, and is referred to as the nucleus. The logical connectivity between the nucleus and a port of the logical node is referred to as a spoke. The concatenation of two spokes represents traversal of a symmetric peer group. The symmetric star topology is used as the “default node representation”, which consists of a single value for each nodal state parameter giving a presumed value between any entry or exit of the logical node and the nucleus, in either direction.

Usually peer groups are not symmetric. For example they may contain “outliers”, i.e. nodes whose removal would significantly improve the peer group symmetry. This asymmetry can be modeled by a set of “exceptions.” Exceptions can be used to represent particular ports whose connectivity to the nucleus is significantly different from the default. Additionally, an exception can be used to represent connectivity between two ports, i.e., a bypass, that is significantly better than that implied by traversing the nucleus.

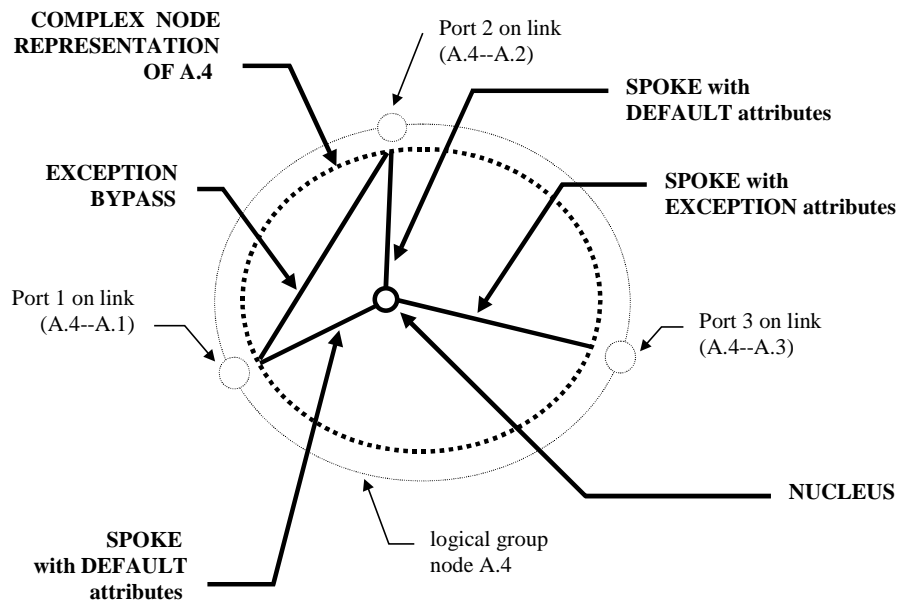

Figure 3-5: Complex node representation of LGN A.4 from Figure 3-3.

The complex node representation is illustrated in the following example. Consider peer group A.4 in Figure 3-3 and its summarization into the complex node represented in Figure 3-5. The nucleus represents the inside of the logical group node A.4. Each spoke emanating from the nucleus is associated with a port of the logical group node A.4. Figure 3-5 includes three spokes, one for each port. The three ports relate to Figure 3-3 as follows:

- Port 1 represents the port on link (A.4--A.1).
- Port 2 represents the port on link (A.4--A.2).
- Port 3 represents the port on link (A.4--A.3).

Note that the spokes for ports 1 and 2 use the default attributes, while the spoke for port 3 is an exception. One possible cause for the exception would be if nodes A.4.1 through A.4.5 are closely clustered whereas A.4.6 is a distant outlier.

Node traversal can also be modeled by an exception that bypasses the nucleus. For example (Figure 3-5) the Exception Bypass joining port 1 to port 2 corresponds to traversing A.4 when going between nodes A.1 and A.2. This exception could be caused by a very high speed bypass link between nodes A.4.2 and A.4.5

Node A.4 distributes its complex node representation via flooding of PTSEs to A.1, A.2 and A.3. The PTSEs are then passed down to the respective peer group leaders (Section 3.3.3) who in turn flood them across their own groups with the result that the topology databases of all nodes in peer groups A.1, A.2, A.3, and A.4 contain the complex node representation of A.4.

Routing across a logical group node corresponds to choosing a concatenation of spokes and/or bypasses. There is never a case where more than two spokes are included in such a concatenation, or there would be a loop. The concatenation must be selected to meet the resource requirements of the call. For example (Figures 3-3 and 3-5) assume logical link (A.1--A.2) is congested so that node A.3.4 routes to a node inside peer group A.1 either via logical links (A.3--A.4), (A.4--A.1) or (A.3--A.2), (A.2--A.4), (A.4--A.1). Furthermore assume that the two paths are equivalent from the routing criteria point of view (plausible since both traverse similar number of links). Then path selection corresponds to choosing the best of three possible complex node traversals (Figure 3-5):

1. Concatenation of the two spokes with default attributes.
2. Concatenation of the Exception spoke and a spoke with default attributes.
3. Exception Bypass.

If the best is Exception Bypass then (A.3--A.2), (A.2--A.4), (A.4--A.1) is the preferred route. Node A.3.4 will therefore use the link (A.4.2--A.4.5) when routing to a node inside peer group A.1.

Routing to an internal reachable address in a logical group node corresponds to choosing a spoke or a concatenation of bypasses and a spoke to the nucleus with acceptable attributes.

3.4 Completing The PNNI Routing Hierarchy

In this section the PNNI routing hierarchy description is completed by focusing on the recursive nature of the peer groups.

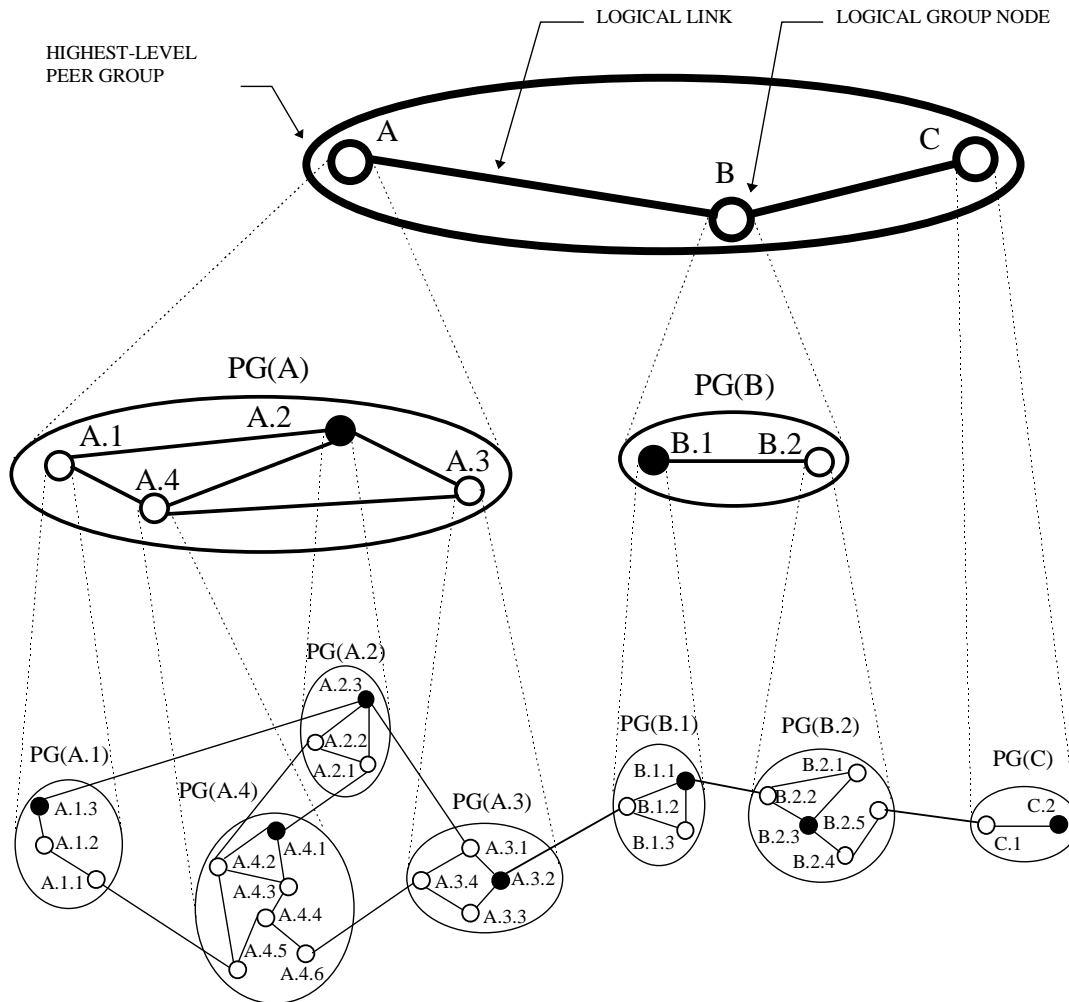

Figure 3-6: Example of a complete PNNI hierarchically configured network.

3.4.1 Progressing To The Highest Level Peer Group

The PNNI routing hierarchy example of the previous sections is still incomplete. The higher level peer groups (Figure 3-3) do not exhibit connectivity among each other. Figure 3-6 shows one possible completion of the hierarchy. Completion is achieved by creating ever higher levels of peer groups until the entire network is encompassed in a single highest level peer group. In the example of Figure 3-6 this is achieved by configuring one more peer group containing logical group nodes A, B and C. Node A represents peer group A which in turn represents peer groups A.1, A.2, A.3, A.4 and so on. Another possible configuration would be if peer groups B and C were aggregated into a peer group BC which was then aggregated with peer group A to form the highest level peer group. The network designer controls the hierarchy via configuration parameters that define the logical nodes and peer groups.

The hierarchical structure is very flexible. The upper limit on successive, child/parent related, peer groups is given by the maximum number of ever shorter address prefixes that can be derived from longest 13 octet address prefix. This equates to 104, more than enough since even international networks can be more than adequately configured with less than 10 levels of ancestry.

3.4.2 Uplinks And Horizontal links Revisited

The PNNI routing hierarchy allows asymmetries in the sense that for a given lower level peer group its parent peer group can simultaneously be a grandparent or great-grandparent peer group to some other lower level peer group. For example, the lower level peer group C, in Figure 3-6, is directly represented in the highest level peer group by logical group node C whereas lower level peer groups B.1 and B.2 are first grouped into the parent peer group B before being represented at the highest level by logical group node B.

The uplinks in this scenario are shown in Figure 3-7. The creation of the four uplinks (B.2.5--C), (C.1--B), (B.1.1--B.2) and (B.2.2--B.1) are covered in Section 3.3.4. However, uplink (B.2--C) is different in that it is derived from uplink (B.2.5--C). This is called an “induced uplink.”

When peer group leader B.2.3 receives the PTSE (flooded by B.2.5) describing the uplink (B.2.5--C) it passes the common peer group ID (the highest level peer group in this case) and the ATM End System Address of the upnode C to its LGN B.2. From this information, B.2 recognizes that node C is not a member of peer group B. It therefore derives a new uplink (B.2--C) that expresses the reachability to C from the perspective of B.2. Since B.2 represents B.2.5, (B.2--C) is a higher level representation of (B.2.5--C).

If another link were to connect B.2.1 to C.1, then uplink (B.2--C) could represent the aggregation of two lower level uplinks, namely (B.2.5--C) and (B.2.1--C). This would be determined by the aggregation tokens in the two uplinks.

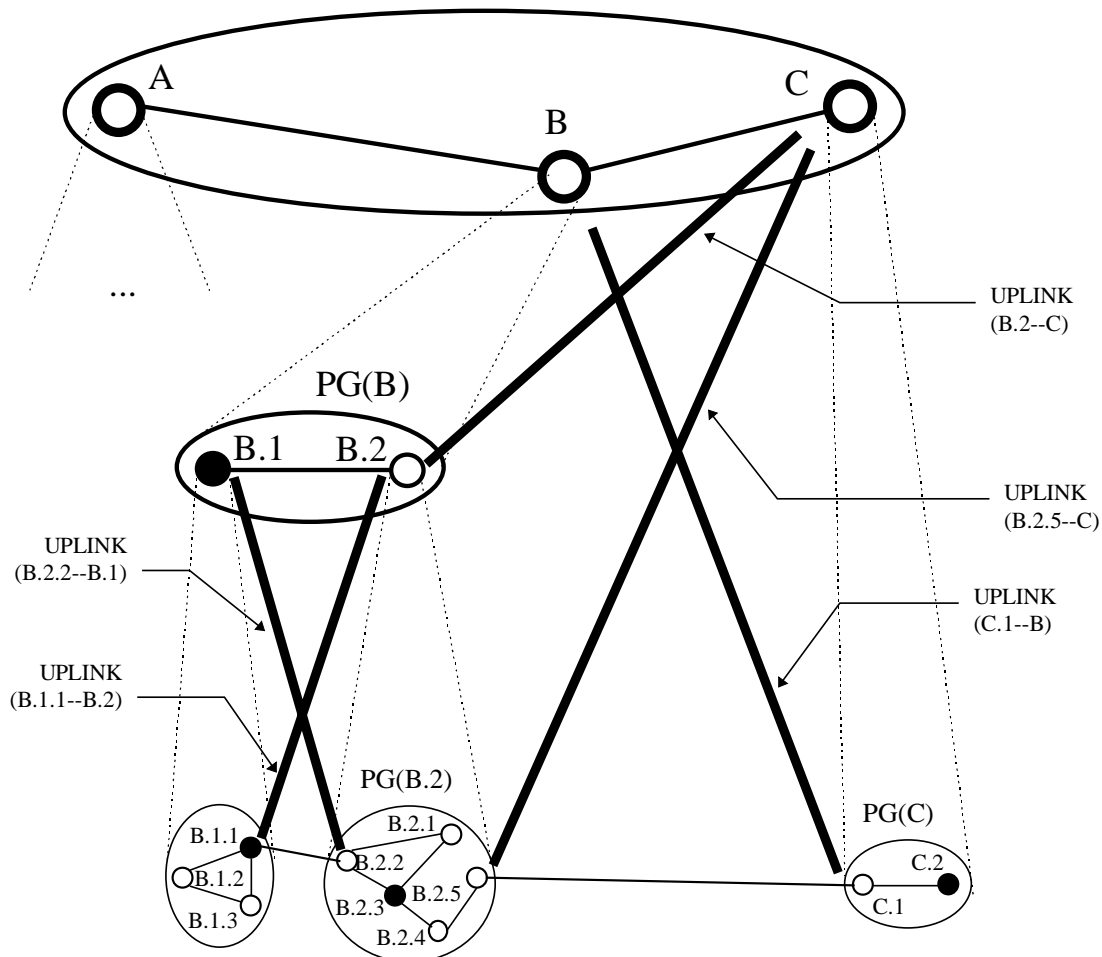

Figure 3-7: Uplinks revisited.

Induced uplinks may also be derived from induced uplinks at the next lower level. In the example, if there were additional peer groups between peer group B and the highest level peer group, there would be additional uplinks derived to upnode C.

An SVCC-based RCC is established between LGNs B and C as follows. After creating the uplink (B.2--C), B.2 floods its peer group B with a PTSE specifying the new uplink. On receiving the uplink information, peer group leader B.1 passes the common peer group ID (the highest level peer group in this case) and the ATM End System Address of the upnode C to its LGN B. Node B recognizes from this that node C is located in its peer group and now has sufficient information to set up the SVCC-based RCC between LGNs B and C.

- Node B chooses a path to node C through one of the border nodes advertising an uplink to C. In this example, B.2 is the only border node advertising an uplink to upnode C, and therefore the SVCC will transit border node B.2.

3.4.3 Recursion in the Hierarchy

The creation of a PNNI routing hierarchy can be viewed as the recursive generation of peer groups, beginning with a network of lowest-level nodes and ending with a single top-level peer group encompassing the entire PNNI routing domain. The hierarchical structure is determined by the way in which peer group IDs are associated with logical group nodes by configuration. From this perspective the key element of a PNNI routing hierarchy is the peer group structure.

Generally, the behavior of a peer group is independent of its level. Thus the descriptions in Section 3.3 apply to all peer groups. However, the highest level peer group differs in that it does not need a peer group leader since there is no parent peer group in which to represent it.

3.5 Address Summarization & Reachability

3.5.1 General algorithm³

Address summarization reduces the amount of addressing information which needs to be distributed in a PNNI network and thus contributes to scaling in large networks. It consists of using a single “reachable address prefix” to represent a collection of end system and/or node addresses that begin with the given prefix. Reachable address prefixes can be either summary addresses or foreign addresses.

A “summary address” associated with a node is an address prefix that is either explicitly configured at that node or that takes on some default value. A “foreign address” associated with a node is an address which does not match any of the node’s summary addresses. By contrast a “native address” is an address that matches one of the node’s summary addresses.

These concepts are clarified in the example depicted in Figure 3-8 which is derived from Figure 3-6. The attachments to nodes A.2.1, A.2.2 and A.2.3 represent end systems. The alphanumeric associated with each end system represents that end system’s ATM address. For example <A.2.3.2> represents an ATM address, and P<A.2.3>, P<A.2>, and P<A> represent successively shorter prefixes of that same ATM address.

An example list of configured summary addresses for each node in peer group A.2 is as follows:

Table 3-1: Configured Summary Addresses

Summary Addr at A.2.1	Summary Addr at A.2.2	Summary Addr at A.2.3
P<A.2.1> (configured)	P<Y.1> (configured)	P<A.2.3> (configured)
P<Y.2> (configured)	P<Z.2> (configured)	

Other summary addresses could have been chosen, for example P<Y.1.1> instead of P<Y.1> at node A.2.2 or P<W> at node A.2.1. But P<A.2> could not have been chosen (instead of P<A.2.1> or P<A.2.3>) as default summary address at nodes A.2.1 and A.2.3 since a remote node selecting a route would not be able to differentiate between the end systems attached to A.2.3 and the end systems attached to A.2.1. Note that for the chosen summary address list at A.2.1, P<W.1.1.1> is a foreign address since it does not match any of the summary addresses of node A.2.1.

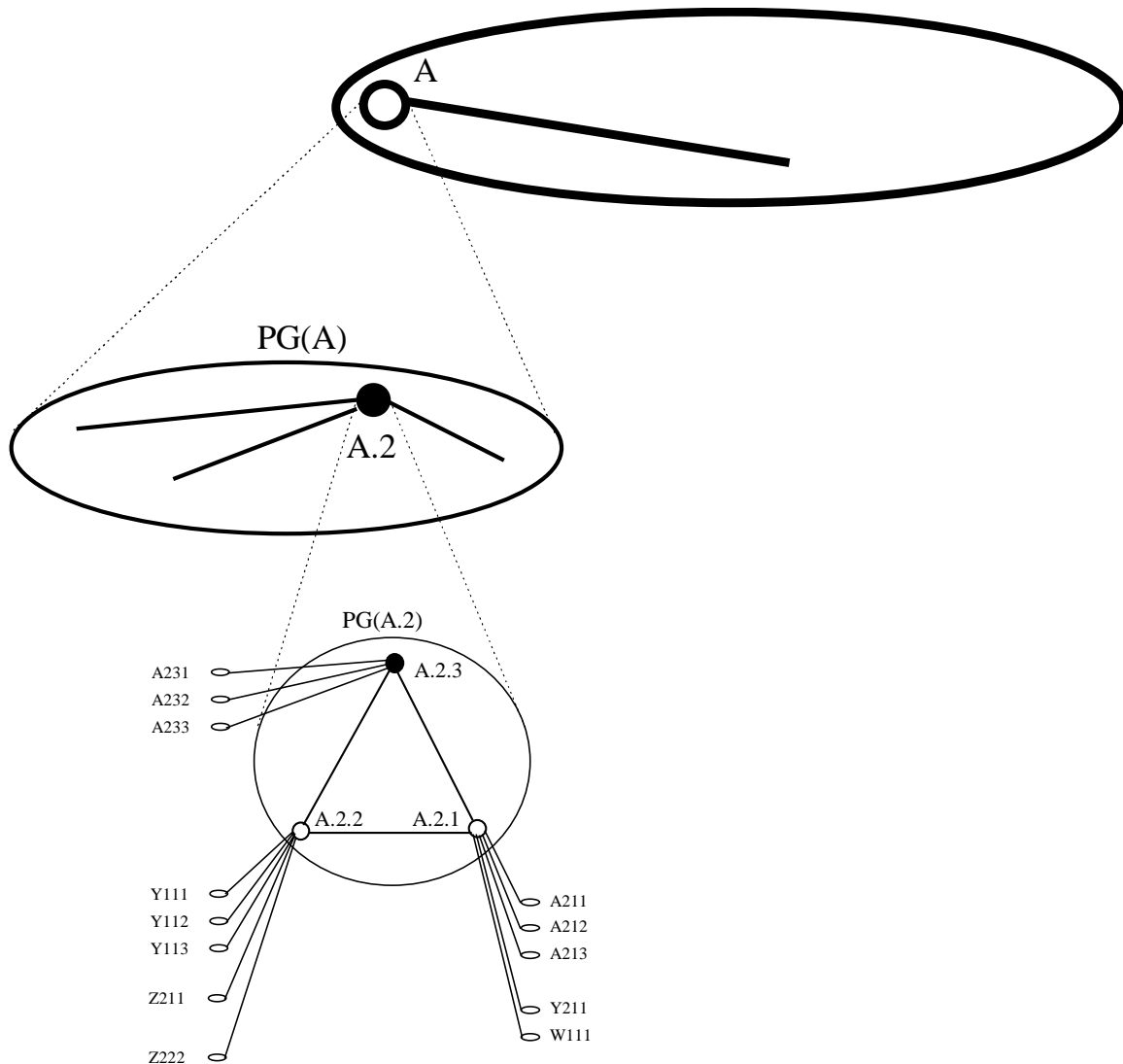

Figure 3-8: Address summarization in a PNNI hierarchy.

LGN A.2 requires its own list of summary addresses. Here again there are different alternatives. As PG(A.2) is the ID of peer group A.2 it is reasonable to include P<A.2> as a default summary address. Furthermore since summary addresses P<Y.1> and P<Y.2> can be further summarized by P<Y>, it also makes sense to configure P<Y> as a summary address in this list:

Table 3-2: Summary Address List

Summary Addr List of LGN A.2
P<A.2> (default)
P<Y> (configured)

P<Z.2> is not included in the summary address list of LGN A.2 so as to demonstrate what happens in such a situation. It should be noted that every node in peer group A.2 having the potential to become peer group leader should have the same summary address list in its LGN configuration.

The following table shows the reachable address prefixes advertised by each node in peer group A.2:

Table 3-3: Advertised Reachable Address Prefixes

Reachable Addr Prefixes flooded by node A.2.1	Reachable Addr Prefixes flooded by node A.2.2	Reachable Addr Prefixes flooded by node A.2.3
P<A.2.1> P<Y.2> P<W.1.1.1>	P<A.2.2> P<Y.1> P<Z.2>	P<A.2.3>

As expected, node A.2.1 floods its summary addresses plus its foreign address whereas nodes A.2.2 and A.2.3 only issue summary addresses since they lack foreign addressed end systems.

Reachability information, i.e., reachable address prefixes, are fed throughout the PNNI routing hierarchy so that all nodes can reach the end systems with addresses summarized by these prefixes. A filtering is associated with this information flow to achieve further summarization wherever possible, i.e. LGN A.2 attempts to summarize every reachable address prefix advertised in peer group A.2 by matching it against all summary addresses contained in its list (see Table 3-2). For example when LGN A.2 receives (via PGL A.2.3) the reachable address prefix P<Y.1> issued by node A.2.2 (see Table 3-1) and finds a match with its configured summary address P<Y>, LGN A.2 achieves a further summarization by advertising its summary address P<Y> instead of the longer reachable address prefix P<Y.1>.

There is another filtering associated with advertising of reachability information to limit the distribution of reachable address prefixes. By associating an “suppressed summary address” with the address(es) of end system(s), advertising by an LGN of that summary address is inhibited. This option allows some addresses in the lower level peer group to be hidden from higher levels of the hierarchy, and hence other peer groups. This feature can be implemented for security reasons, making the presence of a particular end system address unknown outside a certain peer group.

Reachable address prefixes that cannot be further summarized by the LGN A.2 are advertised unmodified. For example when LGN A.2 receives the reachable address prefix P<Z.2> issued by A.2.2, the match against all its summary addresses (Table 3-2) fails, consequently LGN A.2 advertises P<Z.2> unmodified. Note that LGN A.2 views P<Z.2> as foreign since the match against all its summary addresses failed, even though P<Z.2> is a summary address from the perspective of node A.2.2. The resulting reachability information advertised by LGN A.2 is listed in Table 3-4:

Table 3-4: Advertised Reachability Information

Reachability information advertised by LGN A.2.
P<A.2> P<Y> P<Z.2> P<W.1.1.1>

Note that the reachability information advertised by node A.2.3 is different than that advertised by LGN A.2 as shown in Tables 3-3 and 3-4, even though node A.2.3 is PGL of peer group A.2. The reachability information advertised by LGN A.2 is the only reachability information about this peer group available outside of the peer group.

The relationship between LGN A and peer group leader A.2 is similar to the relationship between LGN A.2 and peer group leader A.2.3. If LGN A is configured without summary addresses, then it would advertise all reachable address prefixes that were flooded across peer group A into the highest peer group (including the entire list in Table 3-4). On the other hand if LGN A is configured with the default summary address P<A> (default because the ID of peer group A is PG(A)) then it will attempt to further summarize every reachable address prefix beginning with P<A> before advertising it. For example it will advertise the summary address P<A> instead of the address prefix P<A.2> (see Table 3-4) flooded by LGN A.2.

The ATM addresses of the logical nodes are subject to the same summarization rules as end system addresses.

The reachability information (reachable address prefixes) issued by a specific PNNI node is advertised across and up successive (parent) peer groups, then down and across successive (child) peer groups to eventually reach all PNNI nodes lying outside the specified node.

3.5.2 Handling E.164 address prefixes and E.164 destination addresses³

E.164 AESA addresses in PNNI signalling are encoded just as defined by ITU. This means that an ATM End System address which contains an international E.164 number (right justified) looks like:

AFI=45 Or AFI=C3	0.....0	int'l E.164 #	F	HO-DSP	ESI	SEL
		IDI				

For the purposes of advertising prefixes in PNNI, and for matching such addresses against prefixes, the address must be converted to an AESA in which the E.164 is left justified in the IDI, i.e. the left padded 0x0s are replaced with right padded 0xFs, resulting in:

AFI=45 Or AFI=C3	int'l E.164 #	F.....F	F	HO-DSP	ESI	SEL
	IDI					

This conversion in representation is performed on all PNNI reachability advertisements before they are advertised. The logic for matching an address against such prefixes is described in terms of this same conversion into a left-justified E.164 address. Actual operation of an implementation is an internal matter as long as the correct results are achieved.

3.5.2.1 E.164 prefixes³

When an E.164 prefix is to be used with PNNI, it is converted into the form described above. The length of the converted prefix depends upon whether there are significant bits in the DSP.

For an E.164 prefix where there are significant bits in the DSP, the length of the converted prefix is the same as the original length, in order to preserve those bits. Any address matching such a prefix must have the precise E.164 address specified in the prefix.

For an E.164 prefix where all significant bits are in the IDI, the length of the converted prefix is shortened to omit the trailing 0xF in the IDI. Thus, an E.164 prefix of 1-2-3 will match any AESA with an E.164 content whose most significant three digits are 1-2-3.

3.5.3 Address Scoping

Reachability information advertised by a logical node always has a scope associated with it. The scope denotes a level in the PNNI routing hierarchy, and it is the highest level at which this address can be advertised or summarized. If an address has a scope indicating a level lower than the level of the node, the node will not advertise the address. If the scope indicates a level that is equal to or higher than the level of the node, the address will be advertised in the node's peer group.

When summarizing addresses, the address to be summarized with the highest scope will determine the scope of the summary address. The same rule applies to group addresses, i.e. if two or more nodes in a peer group advertise reachability to the same group address but with different scope, their parent node will advertise reachability to the group address with the highest scope.

Note that rules related to address suppression take precedence over those for scope.

3.5.3.1 An Example of Address Summarization with Address Scoping

In this section we present a very simple and artificial example, but one that demonstrates most of the possible default cases of address summarization. Suppose we have the very simple network shown in Figure 3-9 consisting three levels of hierarchy and of only two nodes. Suppose also that the number of addresses required to prevent suppression is configured to 1.

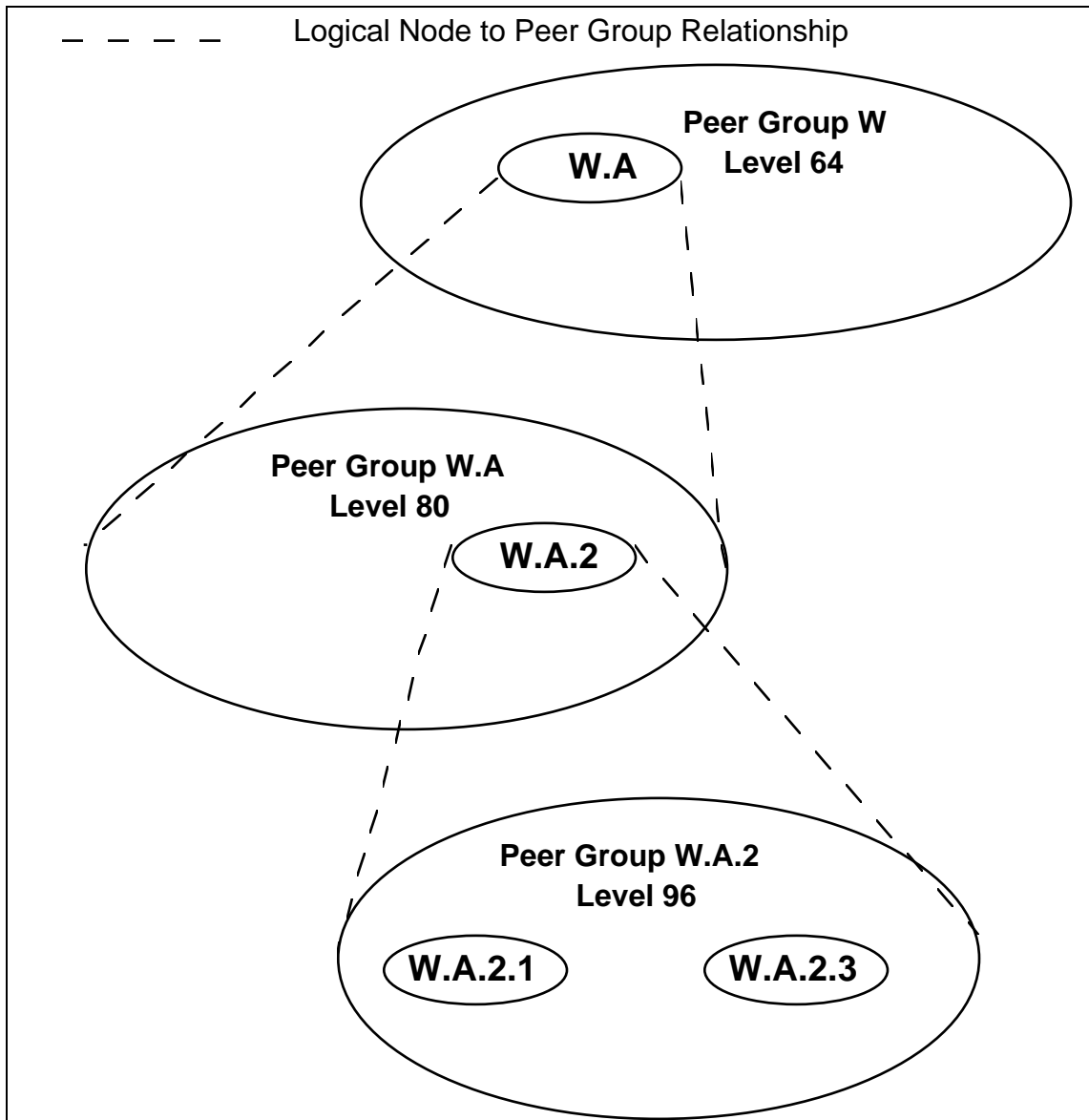

Figure 3-9: Sample Network

Suppose Node W.A.2.1 which is at level 96 has the following reachable addresses:

- W.A.2.1.ddd
- W.A.2.1.eee
- W.A.2.3.fff
- W.F.2.7.zzz
- A.N.Y.C.ast1 Scope 80
- A.N.Y.C.ast2 Scope 104
- A.N.Y.C.ast3 Scope 96
- A.N.Y.C.ast4 Scope 72

The node would advertise these as follows:

- W.A.2.1
- W.A.2.3.fff
- W.F.2.7.zzz
- A.N.Y.C.ast1 Scope 80
- A.N.Y.C.ast3 Scope 96
- A.N.Y.C.ast4 Scope 72

W.A.2.1 is the node's summary address by default. The addresses which match this are not advertised. The address A.N.Y.C.ast2 was not advertised since its scope, 104, is lower than the node's level.

Node W.A.2.3 is also at level 96 and has the following addresses attached.

- W.A.2.3.aaa
- W.A.2.3.bbb
- W.A.2.3.ccc
- W.F.1.5.xxx
- W.F.2.7.yyy
- A.N.Y.C.ast3 Scope 80

The node would advertise these as follows:

- W.A.2.3
- W.F.1.5.xxx
- W.F.2.7.yyy
- A.N.Y.C.ast3 Scope 80

Node W.A.2 is at level 80. The Peer Group Leader of Peer Group W.A.2 (this same physical node but operating at level 96) has received the addresses advertised by the two nodes. These are fed to the logical group node W.A.2 which summarizes them as follows:

- W.A.2
- W.F.1.5.xxx
- W.F.2.7.yyy
- W.F.2.7.zzz
- A.N.Y.C.ast1 Scope 80
- A.N.Y.C.ast3..Scope 80
- A.N.Y.C.ast4 Scope 72

W.A.2 is the default summary address for this node. All address which match it are suppressed. The address A.N.Y.C.ast3 is advertised because one of the two instances of this had sufficient scope. Node logical group node W.A is at level 64. It again summarizes the addresses as follows:

- W.A
- W.F.1.5.xxx
- W.F.2.7.yyy
- W.F.2.7.zzz

Its default summary address is W.A. None of the group address are advertised since they all have a scope greater than level 64.

3.6 Single Node Perspective

This section derives the perspective that a lowest-level node has of the network. This view is informative since it corresponds to the network description contained in the node's topology database(s). Figure 3-10 shows this view for all the nodes contained in the lowest level peer group A.3 of the PNNI routing hierarchy depicted in Figure 3-6. The view is the same for all four nodes A.3.1 to A.3.4 of the group because flooding within peer group A.3 ensures that the topology databases of all its members are identical.

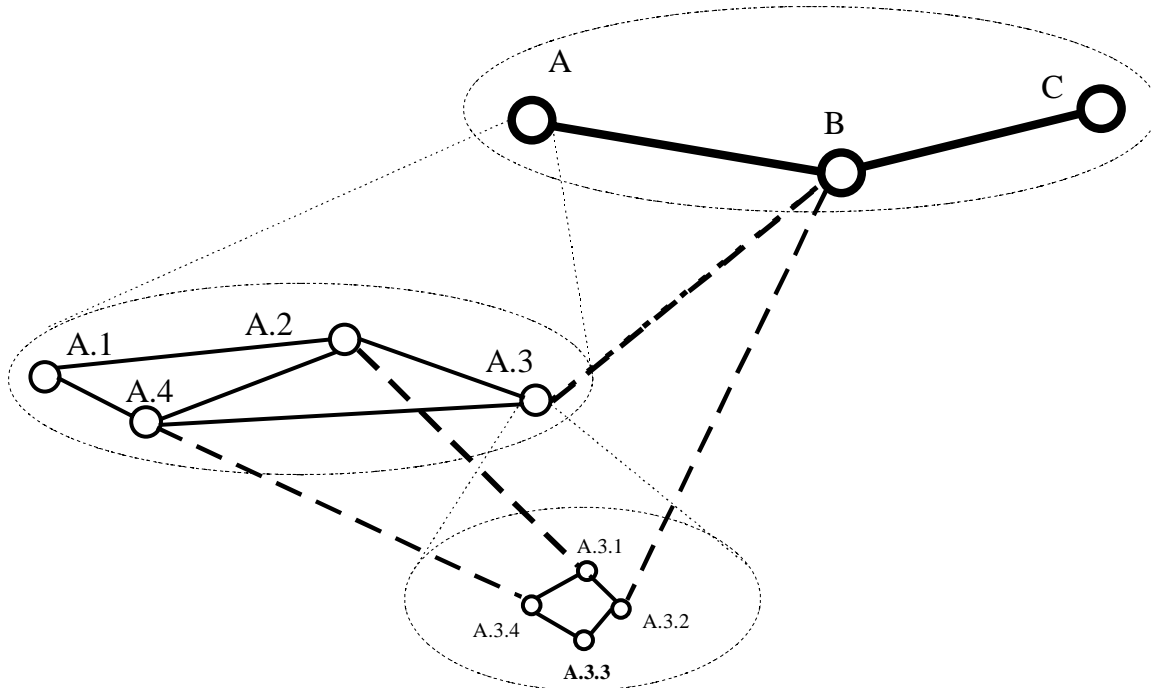

Figure 3-10: View of the network from nodes A.3.3, A.3.2, A.3.1, and A.3.4.

The view shown in Figure 3-10 includes all ancestor peer groups of peer group A.3, i.e. peer group A and the highest level peer group. Generalizing, the view that a peer group has of the rest of the network corresponds to that group's parent peer group and parent peer group of the parent and so on. This is true for any peer group at any hierarchical level.

This example focuses on node A.3.3 and traces how its 'view of the world' evolves. To simplify the scenario it is assumed that the neighbors of A.3.3 are active before A.3.3 comes up. When A.3.3 initializes, two new links appear, (A.3.3--A.3.4) and (A.3.3--A.3.2). The Hello protocols on these new links inform A.3.3 of its neighbors A.3.2 and A.3.4.

Node A.3.3 can now obtain the entire topology database(s) from its neighbors via the initial topology database exchange and via flooding.

The single node perspective of A.3.3 is formed from the PTSEs in the topology database as follows. Node A.3.3 learns the topology of peer group A.3 from information in the PTSEs originated by its peers in peer group A.3. Connectivity to the upnode A.4 in parent peer group A (Figure 3-6) is learned from the uplink (A.3.4--A.4) that was created and flooded by border node A.3.4. Similarly, connectivity to upnode A.2 is learned from the uplink (A.3.1--A.2), that was created and flooded by border node A.3.1. There is no uplink from any node in peer group A.3 to node A.1. Uplinks only provide information about connectivity between lower level peer groups and neighboring upnodes (e.g., A.4 and A.2). Node A.3.3's complete view of the nodes A.1, A.2, and A.4 and the connectivity among them is learned from the PTSEs originated by those nodes.

Connectivity to upnode B (Figure 3-6) is obtained by the uplink (A.3.2--B) created by node A.3.2. Node A.3.3's complete view of the nodes B and C and the connectivity between them is learned from the PTSEs originated by those nodes.

Topology aggregation is implicit in all nodes of Figure 3-10 that do not belong to peer group A.3, the group to which A.3.3 belongs. For example the complex node representation shown in Figure 3-5 is associated with LGN A.4.

Topology aggregation is also implicit in all links of Figure 3-10 that do not belong to peer group A.3. The example demonstrates this for link (A.2--A.4) which represents the aggregation of links (A.2.1--A.4.1) and (A.2.2--A.4.2), contained in Figure 3-6.

In its topology database A.3.3 will have advertisements describing the address prefixes reachable through each node. For example, the reachable address prefixes associated with the end systems attached to nodes A.2.1, A.2.2, A.2.3 (Figures 3-6 and 3-8) are summarized in advertisements from logical group node A.2.

3.7 Path Selection

ATM is a connection-oriented networking technology. That means that a path selected by PNNI for the establishment of a virtual connection or virtual path will remain in use for a potentially extended period of time. This means that the consequences of an inefficient routing decision will affect a connection for as long as that connection remains open. Thus it is critical that PNNI select paths carefully.

ATM allows a user to specify, when setting up a call, Quality of Service (QoS) and bandwidth parameter values that an ATM network must be able to guarantee for that call. Call establishment consists of two operations: (1) the selection of a path, and (2) the setup of the connection state at each point along that path. Path selection is done in such a way that the path chosen appears to be capable of supporting the QoS and bandwidth requested, based on currently available information. The processing of the call setup at each node along the path confirms that the resources requested are in fact available. (If they are not, then crankback occurs, which causes a new path to be computed if possible; thus the final outcome is either the establishment of a path satisfying the request, or refusal of the call.)

To some extent efficient QoS-sensitive path selection is still a research issue. Also, some known algorithms for QoS-sensitive path selection in the presence of multiple constraints require consideration of multiple independent link parameters and are relatively expensive computationally. It is therefore very important that PNNI allows flexibility in the choice of QoS-sensitive path selection algorithms.

There are two basic routing techniques that have been used in networking: source routing and hop-by-hop routing. In source routing, the originating (or source) system selects the path to the destination and other systems on the path obey the source's routing instructions. In hop-by-hop routing, each system independently selects the next hop for that path, which results in progress toward the destination provided that the decisions made at each hop are sufficiently consistent

In principle, either routing technique can be applied to connection-oriented networks, such as ATM. However, hop-by-hop routing does have some disadvantages in this type of network .

The first is the creation of routing loops. There are several possible causes of routing loops:

1. Inconsistency in routing decisions when switches use different routing algorithms
2. Inconsistency in routing databases among the switches (typically due to changes in topology information that have not fully propagated yet)

Inconsistency in routing decisions leads to a fundamental constraint of hop-by-hop routing, which is that the path selection must be fully specified, and all systems must implement it exactly as specified.

Further, due to inconsistency among the routing databases it is also possible for paths to be followed as a consequence of the individual hop by hop decisions that are far from optimal yet contain no loops. Any connection established with such an inefficient path will use that path for as long as that connection remains open.

Another disadvantage of hop-by-hop routing is that it replicates the cost of the path selection at each system. While this is less serious for connection-oriented networks (where the cost only occurs at connection setup) the QoS-sensitive path selection of PNNI may be far more costly.

In source routing, the source is responsible for selecting the path to the destination. It does this based on its local knowledge of the network topology. Since only one database is involved, loops are not possible, nor will the paths be inefficient due to database inconsistency. Furthermore, since only the source selects the path, the algorithm used need not be the same in every system, and the cost of executing it is only incurred once. In addition, it is much easier to do path selection based on specialized considerations, because there is no requirement for the algorithms to be consistent among all the nodes.

To avoid the difficulties stated above of using hop by hop routing with connection oriented service, and to gain the advantages of source routing, PNNI uses source routing for all connection setup requests. This implies that the first node in a peer group selects the entire path across that peer group. The path is encoded as a Designated Transit List (DTL) which is explicitly included in the connection setup request. The DTL specifies every node used in transit across the peer group, and may optionally also specify the logical links which are used between those nodes. If a node along the path is unable to follow the DTL for a specific connection setup request due to lack of resources, then the node must refuse that request and must crankback the request to the node that created the DTL.

Since PNNI allows for multi-level hierarchical routing, the originating switch selects a path to the destination containing all the detail of the hierarchy known to it. This is called a hierarchically complete source route. Such a path is not a fully detailed source route because it does not contain the details of the path outside the originator's peer group. Instead, those portions of the path are abstracted as a sequence of logical group nodes to be transited. When the call setup arrives at the entry switching system of a peer group, that switching system is responsible for selecting a (lower level) source route describing the transit across that peer group. Naturally, the path used to cross a lower level peer group must be consistent with the higher level path (i.e., must reach the "next hop" destination specified by the higher level path).

The use of source routing implies that only one node is involved in the actual selection of the path followed across any one peer group by any one specific connection setup request. This implies that it is not necessary for each node in a peer group to use the same path selection algorithm. Rather, each node may use whatever path is felt most appropriate given the capabilities of that node and the constraints of the call. Different nodes may use different path selection algorithms for a variety of reasons, such as transition to a new software release, for networks in which nodes have significantly different processing capabilities, or in multi-vendor networks. Similarly, the path selection algorithm used for one level of the PNNI hierarchy may be different from the path selection algorithm used for a different level (subject to the constraint that path selection at any particular lower level must be consistent with the path selected by higher levels).

PNNI therefore does not specify any single required algorithm for path selection. Rather, each implementation is free to use whatever path selection algorithm is felt appropriate. One acceptable path selection algorithm is provided in Appendix H.

3.7.1 Generic Connection Admission Control

The idea of a generic connection admission control (CAC) came from the realization that, since CAC is not to be standardized, it is not feasible to perform the actual CAC to determine if a switching system will admit a new connection.

For each connection request, a path is computed based on information stored in the node's topology database, together with the connection's service category, traffic characteristics, and QoS requirements. The path is chosen to satisfy the connection's end-to-end traffic and QoS requirements as well as to meet network efficiency criteria. During connection setup, each switching system along the chosen path performs CAC to ensure that the connection can be accommodated without jeopardizing QoS guarantees to the existing connections. How a switching system does CAC is not subject for standardization. If a switching system accepts the connection, its ability to accept future connections may change. This will trigger origination of new PTSE instances describing this node's updated resource availability if the changes are significant (see Section 5.8.5.2). The determination of a 'significant' change is algorithmically defined as controlled by configuration parameters. The values of the configuration parameters are chosen to balance the frequency of PTSE updates against the possibility of a failed call attempt due to old information.

A generic CAC is needed in the path selection process to determine if a link or node is likely to have enough resources available to support the proposed connection. A generic CAC should include a link or node if the switching system is likely to accept the proposed connection. Conversely, the generic CAC should exclude a link or node if the switching system is likely to reject the new connection. In essence, a generic CAC predicts the outcome of the actual CAC performed at a switching system.

Using a generic CAC, each switching system is free to use any CAC but is required to advertise a set of topology state parameters carrying some information that can be used by the generic CAC to make its prediction. A generic CAC and the set of topology state parameters supporting it have to be flexible enough to allow any CAC to be approximated reasonably well.

4. PNNI Signalling Description

4.1 Introduction

ATM signalling is a set of protocols used for call/connection establishment and clearing over ATM interfaces. The interfaces of interest to the ATM Forum are illustrated in Figure 4-1.

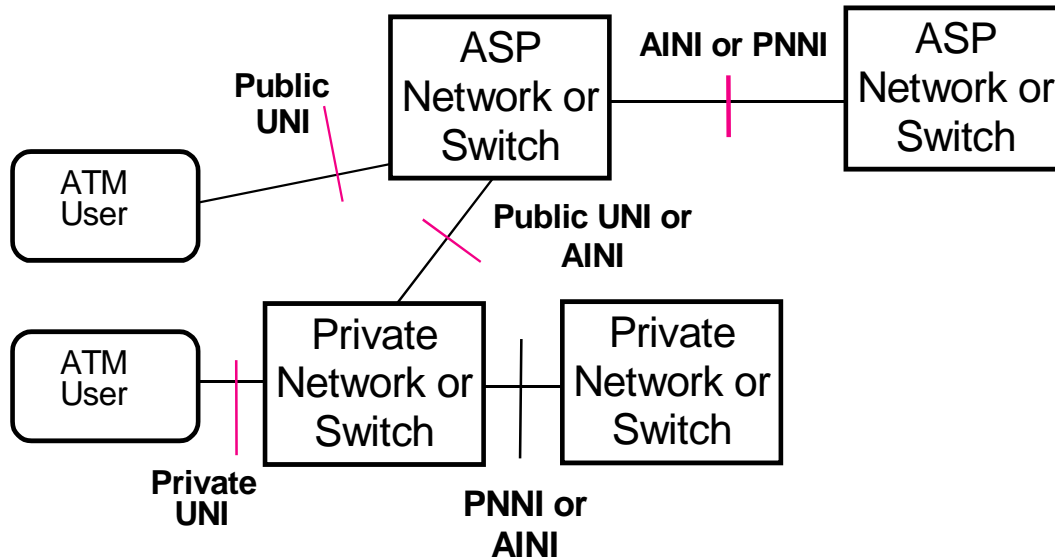

Where:

Public UNI: the user network interface between an ATM user and a public ATM network

Private UNI: the user network interface between an ATM user and a private ATM network

B-ICI: the network network interface between two public networks or switching systems. B-ICI stands for B-ISDN Inter-Carrier Interface.

Private NNI: the network network interface between two private networks or switching systems.

Figure 4-1: ATM Interfaces

This chapter provides a description of the signalling procedures over the PNNI interface. These procedures enable calls to be setup across a private ATM network that is executing the PNNI protocol. [A detailed definition of the PNNI Signalling protocol is given in Chapter 6. In case of discrepancies, the material in Chapter 6 has precedence over this chapter.](#)³

4.2 Overview

~~PNNI signalling is based on a subset of UNI 4.0 signalling. It does not support some UNI 4.0 signalling features such as proxy signalling, leaf initiated join capability or user to user supplementary service, but adds new features which pertain to the use of PNNI routing for dynamic call setup. In addition, PNNI signalling differs from UNI 4.0 signalling in that it is symmetric.~~

~~PNNI 1.1 Signalling is based on the UNI Signalling 4.1 specification and supports all capabilities defined in UNI Signalling 4.1, except proxy signalling. PNNI 1.1 Signalling also adds new features which pertain to the use of PNNI Routing for dynamic call setup. In addition, PNNI signalling differs from UNI Signalling 4.1 in that it is symmetric.~~³

PNNI signalling makes use of the information gathered by PNNI routing. Specifically, it uses the route calculations derived from the reachability, connectivity, and resource information dynamically maintained by PNNI routing. These routes are calculated as needed from the node's view of the current topology.

In order to meet the requirements, PNNI signalling uses four additional features beyond those defined for UNI signalling. Designated Transit Lists (DTLs) are used to carry hierarchically-complete source routes. Crankback and alternate routing allows for attempting alternate paths to cope with inaccurate information. Associated signalling is used for PNNI operation over virtual path connections. Soft permanent VPCs/VCCs (Soft PVPC/PVCCs) are supported.

4.3 Associated Signalling

By default (if no VPCs are configured for use as logical links on the interface), the signalling channel on VPI=0 controls all of the virtual paths on the physical interface. PNNI also supports signalling and routing over multiple virtual path connections (VPCs) to multiple destinations through a single physical interface. In this situation, each VPC configured for use as a logical link has a signalling channel associated with it. Virtual channels within these VPCs are controlled only by the associated signalling channel of that particular VPC, i.e., the default signalling channel (on VPI=0) on the same physical interface does not control virtual channels within VPCs used as logical links, but does control all the remaining virtual channels and virtual paths on the physical link. This use of the VPI=0 signalling channel is a special case of the Non-Associated Signalling capability defined in Q.2931.

4.4 Designated Transit Lists

In processing a call, PNNI signalling may request a route from PNNI routing. PNNI specifies routes using DTLs. A DTL is a complete path across a peer group, consisting of a sequence of Node IDs and optionally Port IDs traversing the peer group. It is provided by the source node (i.e., DTL originator) or an entry border node to a peer group. A hierarchically complete source route represents a route across a PNNI routing domain that includes each hierarchical routing level between the current level and the lowest visible level in which the source and destination are reachable. This is expressed as a sequence of DTLs ordered from lowest to highest peer group level and organized as a stack (i.e., a last in, first out data structure). The DTL at the top of the stack is the DTL corresponding to the lowest level peer group.

4.5 Crankback

When creating a DTL, a node uses the currently available information about resources and connectivity. That information may be inaccurate for a number of reasons. These reasons include hierarchical aggregation and changes in resource availability due to additional calls which have been placed since the information was produced. Therefore a call being processed according to the DTL may be blocked along its specified route. Crankback and alternate routing is a mechanism for adapting to this situation short of clearing the call back to the source. When the call cannot be processed according to the DTL, it is cranked back to the creator of that DTL with an indication of the problem. This node may choose an alternate path over which to progress the call or may further crankback the call. An alternate path must obey all received higher-level DTLs, and must avoid the blocked node(s) or link(s).

4.6 Soft PVPCs and PVCCs

A PVPC or PVCC is a permanent virtual path connection or virtual channel connection. The qualifier “permanent” signifies that it is established administratively (i.e., by network management) rather than on demand (i.e., by the use of signalling across the UNI). A Soft PVPC or PVCC is one where the establishment within the network is done by signalling. By configuration the switching system at one end of the Soft PVPC or PVCC initiates the signalling for this. These procedures are specified in detail in Annex C.

The network management system provisions one end of the Soft PVPC or PVCC with the address identifying the egress interface from the network. The calling end has the responsibility for establishing, releasing, and (optionally) re-establishing the call.

4.7 An Example of Connection Setup with Crankback

In this section, a detailed example of connection setup including crankback and alternate routing is presented. [We first present an example where path selection and alternate routing are performed dynamically by the nodes. Section 4.7.1 presents an example where a call is initially routed using an explicit route selected by the network manager.](#)³

The network used in this example is shown in Figure 4-2. It is assumed that the link between A.3.3 and B.1.2 is blocked (though the PNNI routing information says that it is OK), and that the link between A.3.1 and B.2.3 cannot support the high peak cell rate requested by the call.

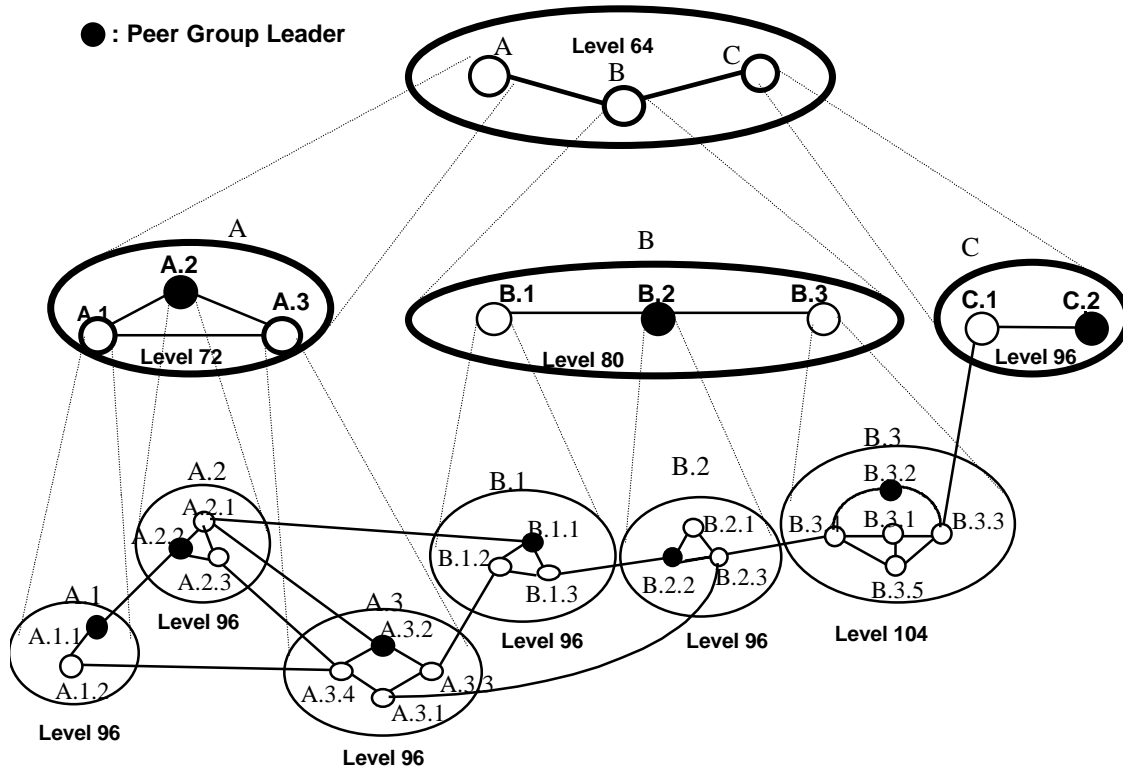

Figure 4-2: A Sample Hierarchical Network

Consider the detailed picture of peer groups A.[1--3] and B.[1--3] shown in Figure 4-2. Assume a connection is to be setup from an end-system A.1.2.x attached to switching system A.1.2 to an end system B.3.3.y attached to switching system B.3.3. A.1.2.x sends the setup request to A.1.2 as a normal UNI SETUP. A.1.2 examines its view of the world. The destination address B.3.3.y is reported as reachable through node B. Note that B as it appears in the name of the peer group may be a different bit string than the B that is part of the ATM-endpoint address of the destination. That is why the advertisement from B explicitly includes the prefixes of the reachable addresses. As mentioned above, it is likely that the PTSE from node B is actually announcing that it can reach an address prefix describing multiple end systems, which include end system B.3.3.y.

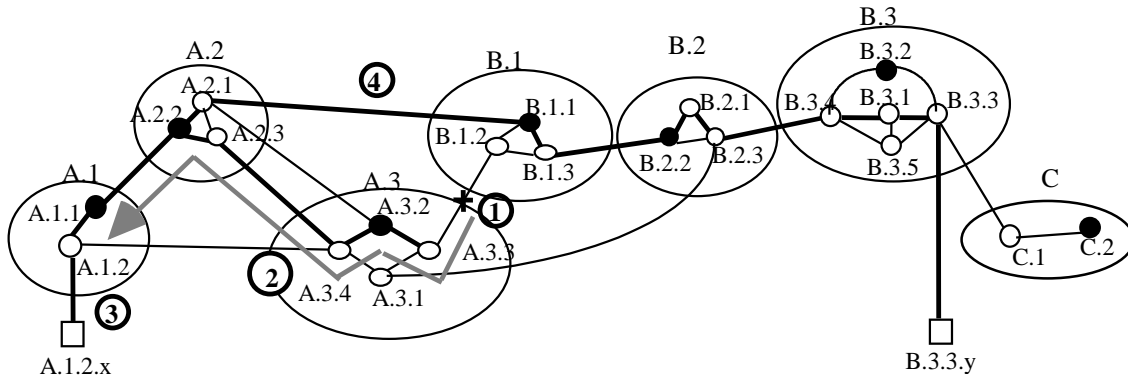

Figure 4-3: An Example of Crankback and Alternate Routing

Examining the topology, A.1.2 finds that the path is either (A.1.2, A.1.1, A.2, A.3, B), (A.1.2, A.1.1, A.2, B), or (A.1.2, A.3, B). Let us assume that on the basis of metrics and policy, A.1.2 chooses (A.1.2, A.1.1, A.2, A.3, B). We will then build three DTLs, in a stack:

```
DTL:[A.1.2, A.1.1], pointer-2
DTL:[A.1, A.2, A.3] pointer-1
DTL:[A, B] pointer-1
```

Each DTL lists nodes that the call setup needs to visit at a given hierarchical level (with the current node included). The current transit pointer following each DTL specifies which element in the list is currently being visited at that level, except that the top DTL is advanced by one to indicate which node will be visited next. Note that the transit pointer is not actually encoded as an index, but rather as an octet offset. For clarity, it is shown simply as an index in this section. The DTL lists are ordered as a stack of DTLs (i.e., the top DTL is acted on; when the end of the top DTL is reached, it is removed from the call request and the next DTL is examined).

Before forwarding the call setup, A.1.2 stores the content of the SETUP message, in case alternate routing will be required. A.1.2 then forwards the call setup to his neighbor A.1.1. A.1.1 examines the top DTL and notices the DTL pointing to its own Node ID. A.1.1 looks for the next entry in the top DTL, but finds it exhausted. Looking at the next DTL, the next destination is A.2. Since A.1.1 is not A.2 (i.e., A.1.1 is not in the peer group summarized into logical node A.2), it starts looking to see how to get to A.2. A.1.1 finds that an immediate neighbor is in A.2, so it removes the top DTL and advances the current transit pointer in the next DTL:

```
DTL:[A.1, A.2, A.3] pointer-2
DTL:[A, B] pointer-1
```

Note that A.1.1 did not add any DTLs and did not make any routing decisions, so A.1.1 will not be involved in alternate routing and does not need to make any copies of the SETUP message before forwarding the call setup to A.2.

A.2.2 looks at the top DTL, and sees that the current destination is A.2. Since A.2.2 is in A.2, it looks at the next entry in the DTL, and starts routing to A.3. Analyzing the topology, A.2.2 finds that the path is through A.2.3, so it pushes that DTL onto the list:

```
DTL:[A.2.2, A.2.3] pointer-2
DTL:[A.1, A.2, A.3] pointer-2
DTL:[A, B] pointer-1
```

Since A.2.2 added a DTL to the stack, and may be involved in alternate routing, A.2.2 stores the contents of the received SETUP message and the contents of the DTL that it added on top of the stack, before sending the packet to A.2.3.

A.2.3 first determines that the top DTL target has been reached, and then that the DTL is exhausted. Finally, A.2.3 notices that the next destination on the next DTL is a neighbor, so A.2.3 removes the top DTL and advances the current transit pointer in the next DTL:

DTL:[A.1, A.2, A.3] pointer-3
DTL:[A, B] pointer-1

The setup arrives at A.3.4. Since A.3.4 is in A.3 the target has been reached. That leaves the target as B. A.3.4 builds a route to B, through A.3.2 and A.3.3, and pushes a new DTL on the list:

DTL:[A.3.4, A.3.2, A.3.3] pointer-2
DTL:[A.1, A.2, A.3] pointer-3
DTL:[A, B] pointer-1

Since A.3.4 added a DTL to the stack, and may be involved in alternate routing, A.3.4 stores the contents of the SETUP message before progressing the call to A.3.2.

A.3.2 receives the call setup, advances the current transit pointer, and forwards the setup request to A.3.3. A.3.2 will not be involved in alternate routing, and so does not need to keep any copies of the SETUP message. A.3.3 receives the call setup, and decides to forward the SETUP message to his neighbor in B. Before forwarding the SETUP message, A.3.3 removes the top two DTLs, as both have been exhausted and the SETUP message is departing from A.3.3 and A.3:

DTL:[A, B] pointer-2

At this point, the call setup is blocked, as A.3.3 (the preceding node) finds out either from the CAC internal to A.3.3, or from a RELEASE or a RELEASE COMPLETE message containing a Crankback IE with blocked transit type #2, "call or party has been blocked at the succeeding end of this interface", as indicated by the circle labeled 1. The crankback procedure now begins, with A.3.3 sending back out the preceding interface a RELEASE message. The Crankback IE in the RELEASE message indicates that the call was blocked at the link between A.3.3 and B, as determined from the DTLs from the received SETUP message, and that the Crankback Level is 96 (the level of peer group A.3).

The RELEASE message is received at A.3.2, which did not create any DTLs for this call, so crankback proceeds further. After or while tearing down the succeeding virtual channel, the RELEASE message is sent out the preceding interface in the direction of A.3.4.

The RELEASE message is received at A.3.4, which specified a DTL for this call at level 96, so A.3.4 attempts to do alternate routing. After eliminating the blocked link from consideration, two different paths are found across A.3 to B. One option is through A.3.1 and on to B, the other is through A.3.2, A.3.3, A.3.1, and on to B. However, the link between A.3.1 and B cannot support the high peak cell rate requested in the original SETUP message, so A.3.4 decides to continue the crankback procedure rather than to try one of the other options, as better paths may exist further back along the original path. A.3.4 sends another RELEASE message back through the preceding interface, but changes the blocked transit identifier to show that the link from A.3 to B is blocked, and also changes the Crankback Level to 72 (the level of A.1's peer group) as indicated by the circle labeled 2.

The RELEASE message is received at A.2.3, which did not create any DTLs for this call, so crankback proceeds further (in the direction of A.2.2).

The RELEASE message is received at A.2.2, which did create a DTL for this call. A.2.2 examines the crankback level in the crankback IE, and determines that the level is higher than the level of the DTL that it created, so crankback proceeds further (in the direction of A.1).

The RELEASE message is received at A.1.1, which did not create any DTLs for this call, so crankback proceeds further (in the direction of A.1.2).

The RELEASE message is received at A.1.2. A.1.2 sees that the Crankback Level matches the level of a DTL it specified for this call, and finds a copy of the corresponding SETUP message contents. Alternate routing is attempted, as indicated by the circle numbered 3, and A.1.2 decides to try the path (A.1.2, A.1.1, A.2, B), resulting in the following stack of DTLs:

```
DTL:[A.1.2, A.1.1], pointer-2
DTL:[A.1, A.2], pointer-1
DTL:[A, B], pointer-1
```

A.1.2 then forwards the call setup to A.1.1. A.1.1 removes the top DTL from the stack, advances the current transit pointer in the next DTL, and forwards the call to A.2.2. A.2.2 finds a path through A.2.1 to B, pushes a new DTL onto the stack, and forwards the call setup to A.2.1:

```
DTL:[A.2.2, A.2.1], pointer-2
DTL:[A.1, A.2], pointer-2
DTL:[A, B], pointer-1
```

A.2.1 receives the setup and notes that B is a neighbor. He removes the top two DTLs from the stack, advances the current transit pointer in the next DTL, and forwards the call setup to B.1.1 as indicated by the circle numbered 4 in Figure 4-3:

```
DTL:[A, B], pointer-2
```

B.1.1 receives the setup, and sees that the current DTL destination has been reached. B.1.1 must now build a new source route to descend to the final destination. He notices that the path will go through B.2 to B.3, so he pushes that on. He then calculates that the path through B.1 is simply to B.1.3, so he pushes that on, giving:

```
DTL:[B.1.1, B.1.3] pointer-2
DTL:[B.1, B.2, B.3] pointer-1
DTL:[A, B], pointer-2
```

B.1.1 then forwards the setup to B.1.3. In the usual fashion, after checking, B.1.3 removes the top DTL, advances the DTL pointer, and hands it to his neighbor in B.2. B.2.2 notices that he is the current target, and then finds a path through B.2 to B.3, and pushes that on the list, giving:

```
DTL:[B.2.2, B.2.1, B.2.3] pointer-2
DTL:[B.1, B.2, B.3] pointer-2
DTL:[A, B], pointer-2
```

B.2.2 then forwards the setup to B.2.1.

B.2.1 looks at the top DTL, advances it, and forwards the setup to B.2.3. B.2.3 removes the DTL, advances the pointer, and forwards the setup to his neighbor in B.3. B.3.4 builds a new DTL, giving:

```
DTL:[B.3.4, B.3.1, B.3.3] pointer-2
DTL:[B.1, B.2, B.3] pointer-3
DTL:[A, B], pointer-2
```

B.3.1 looks at the top DTL, advances the current transit pointer, and forwards the setup to B.3.3. B.3.3 determines that it is the DTL terminator for the DTL stack since:

- all DTLs are at the end and
- B.3.3 is a lowest-level node, and
- B.3.3 has reachability to the destination.

B.3.3 then strips the DTL stack from the SETUP message, and forwards the message across the UNI to the destination.

4.7.1 Example of a Connection Setup and Crankback of an Explicitly Routed Call³

There are applications where it is desirable for the network operator to explicitly dictate the exact lowest level nodes and sometimes links that a call is to traverse. A call directed in this manner is called an explicitly routed call. In this section, a detailed example of connection setup including crankback is presented for an explicitly routed call.

One application where explicit routing is useful is to ensure physical path diversity between several calls. Physical path diversity provides enhanced reliability: if two calls are diversely routed, no single failure can affect both calls. This service would most likely be used with Soft PVCs. In order to guarantee diversity, the path through the network must be selected by the network operator and not by PNNI routing because PNNI routing typically has no knowledge of the underlying transmission infrastructure and hence cannot know whether or not two distinct PNNI links share common transmission infrastructure.

Explicitly routed calls carry their explicit route in the DTL stack of the call establishment message, as described in the previous section. However, in the case of an explicit route, all DTL information elements only contain lowest level Node IDs and Port IDs. Moreover, Node IDs from multiple peer groups can be contained in the same DTL information element subject to the maximum size of the DTL information element.

Figure 4-4 provides an example of how an explicitly routed call is progressed through the network.

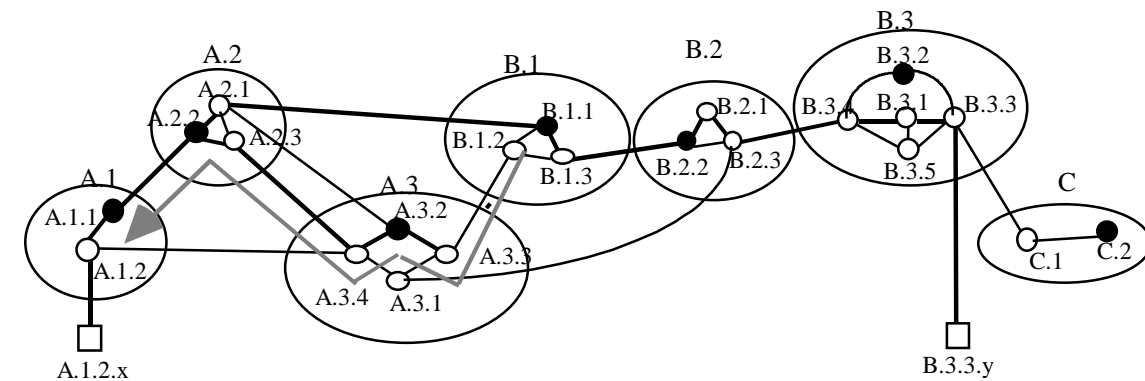

Figure 4-4: An Example of Explicitly Routed Call

Assume that the operator decides that a given Soft PVC is to be routed from node B.1.2 to A.1.2 along the path (B.1.2, A.3.3, A.3.1, A.3.4, A.2.3, A.2.2, A.1.1, A.1.2). The operator wants this path to be used even though there is a shorter path that exists in the network and therefore provides this path as an explicit route to node B.1.2 for this Soft PVC. Node B.1.2 encodes the following DTL information element into the SETUP message:

DTL:[B.1.2, A.3.3, A.3.1, A.3.4, A.2.3, A.2.2, A.1.1, A.1.2], pointer-1

In order to forward the call, B.1.2 must find a link to the next node in the DTL, namely A.3.3. Note that A.3.3 is a lowest level node adjacent to B.1.2 but in a different peer group. Having found a link to A.3.3, B.1.2 forwards the call setup after advancing the DTL pointer, resulting in the following DTL information element:

DTL:[B.1.2, A.3.3, A.3.1, A.3.4, A.2.3, A.2.2, A.1.1, A.1.2], pointer-2

A.3.3 examines the top DTL and notices the DTL pointing to its own Node ID. A.3.3 looks for the next entry in the DTL and finds A.3.1, so it advances the DTL pointer. A.3.3 finds a link to A.3.1 and progresses the call. A.3.1 sees that the DTL is pointing to its own Node ID, so it looks for the next entry in the DTL. It finds A.3.4 to which it has a direct link. So, A.3.1 advances the DTL pointer and progresses the call to A.3.4. A.3.4 notices that the top DTL is pointing to its own Node ID, so it advances the pointer and progresses the call to the next Node ID in the DTL, namely A.2.3, which is in a different peer group. Processing of the DTL continues in this manner by nodes A.2.2 and A.1.1 until node A.1.2 is reached. A.1.2 notes that the DTL is pointing to its own Node ID, so it looks for the next entry in the DTL. A.1.2 determines that it is the DTL terminator for the DTL stack since:

- all DTLs are at the end and
- A.1.2 is a lowest-level node, and
- A.1.2 has reachability to the destination.

A.1.2 then completes the call as for any other Soft PVC connection.

If the path from the source to the destination node were to exceed the number of transits in a single DTL information element, the source node would create a DTL stack, which would contain all lowest level Node IDs from the source to the destination in order. The first DTL information element is processed as explained in the previous example. When the end of a DTL information element is reached, it is popped by the current node at the end of this DTL information element. The current node examines the new topmost element of the DTL stack. For an explicitly routed call, it finds that the Node ID pointed to by the topmost DTL is a lowest level node adjacent to the current node (rather than an ancestor node as in the case of a non-explicitly routed call). This adjacent node may be in the same peer group or in a different peer group than the current node. The call is forwarded to this adjacent node without advancing the DTL pointer and processing of the call continues as explained in the previous example.

It is possible for the call to block along the explicit route and then crankback. In this case, the RELEASE message with the Crankback information element returns all the way to the node that originated the call. No alternate routing is attempted by any entry border node traversed by the call since none of these nodes will have created a DTL for this call. In the example above, if the call had blocked at the link between nodes A.3.1 and A.3.4, the crankback indicating a link blocked between nodes A.3.1 and A.3.4 would be returned all the way to node B.1.2. Node A.3.3 (the entry border node to peer group A.3) would not attempt alternate routing since it did not insert any DTLs for this call.

4.8 Supporting Anycast with Scoping

Reachability information advertised by a logical node, including that to group addresses, has scope associated with it (see Section ~~3.5.4~~3.5.3³). Scope serves two purposes. First, it defines the highest level at which a given reachable address (or prefix) can be advertised. Second, it defines the “service” scope for a given group address used for anycast purposes, i.e., the highest level peer group containing the group address outside of which a calling party will not be allowed to establish connections to.

For each anycast connection request, the user indicates at the UNI, using the connection scope selection IE, the routing scope of the connection, i.e., how far out it is allowing the network to search for the anycast address. Using a local mapping, the first node translates the value of the connection scope selection IE into a PNNI routing level and uses it to compute a route to the anycast address. The PNNI routing level is not carried in PNNI signalling (but the connection scope as specified by the calling user is carried, so it will be available if the call progresses to other routing domains). However, as the example below shows, the DTL IEs carry enough information for entry border nodes to determine the appropriate destination in the case where there are multiple anycast group addresses advertised in its peer group with different scopes.

Consider the network configuration shown in Figure 4-2 and assume the following:

- B.2.1 advertises reachability to group address G1 with scope of 80,
- B.2.3 also advertises reachability to G1, but with scope of 64.

Using the address scoping rules discussed in Section ~~3.5.1~~3.5.3³, B.2 and B will also advertise reachability to G1, and the scope of advertisement will be 64. Suppose a user at A.1.1 requests an anycast connection to G1 with connection scope selection that gets translated locally into a PNNI routing level of 64. Suppose also that from A.1.1's point of view, no nodes in peer group A advertise reachability to G1 (there may be nodes in peer groups A.2 or A.3 advertising reachability to G1, but with scope no larger than their respective peer group). Consequently, A.1.1 computes a route to B and generates the following DTLs: DTL:[A.1.1, A.1.2] pointer-2

DTL:[A.1, A.3] pointer-1

DTL:[A, B] pointer-1

The DTLs will route the connection to B.1.2 where the called party address (i.e., G1) is used for the first time to compute lower-level routes. In this case, B.1.2 will see the reachability advertisement from B.2 to G1 and computes the following DTLs: DTL:[B.1.2, B.1.3] pointer-2

DTL:[B.1, B.2] pointer-1

DTL:[A, B] pointer-2

When the connection setup reaches B.2.2, the called party address is again used to compute lower-level routes. In this case, there are multiple advertisements for G1 seen by B.2.2, namely from B.2.1 and B.2.3. B.2.2 infers from the highest level DTL (i.e., [A, B]) that the calling party is within the peer group containing A and B, but outside peer group B. Therefore, B.2.2 chooses to go to B.2.3, instead of B.2.1.

5. PNNI Routing Specification

This chapter provides the detailed specification of the PNNI routing protocol. The chapter begins with operational procedures that apply to the entirety of the protocol. Sections 5.2 through 5.5 provide specifications of the elements of the system. Sections 5.5 through 5.13 are the procedures to implement PNNI. Section 5.14 contains all of the packet formats.

5.1 General Operational Procedures

5.1.1 Timers

Timers that trigger transmission of messages must be jittered. This is done to prevent unintentional synchronization of transmissions, which could result in network instability.

Jittering is accomplished by applying a new random fractional variance to the time out value each time a timer is reset. The range of the fractional variance is plus or minus 25% of the nominal value.

5.1.2 Packet Transmission

Except for Hello packets (see Section 5.6.2.2) all packets are encoded according to the protocol version given by the Version field of the hello data structure.

5.1.3 Packet Validation

For any received packet, if the packet length in the PNNI packet header exceeds the received data length, the packet shall be discarded without further processing.

If the packet type in the PNNI packet header is not recognized the entire packet shall be discarded.

Any other parsing error in type or length field (including the case where the length is not a multiple of four) can be handled by ignoring the offending element, the enclosing element or by ignoring the entire packet at the discretion of the implementation.

If a packet is received with an unsupported version (see Section 5.6.1), the packet must be discarded, optionally with a management notification. For packets other than Hello packets, any packet received with a supported Version different from the expected value is to be discarded.

5.2 Addressing

5.2.1 ATM End System Addresses (AESAs)³ ~~ATM Addressing Convention~~



Figure 5-1: NSAP Address Structure and Address Prefixes

Addressing and identification of components of the PNNI routing hierarchy are based on use of ATM End System Addresses and/or prefixes applied to ATM End System Addresses. ATM End System Addresses are in turn modeled after NSAP addresses as illustrated in Figure 5-1.

ATM End System Addresses are 20 octets long. PNNI routing only operates on the first 19 octets of the ATM address. The selector (20th) octet has only local significance to the end system and is therefore ignored by PNNI routing. NSAPs are usually assigned by an authority which imposes substructure on the address. PNNI never uses, examines, or interprets the additional substructure if it is present, with one significant exception. The first octet, the Authority and Format Identifier (AFI), is used by PNNI to distinguish between individual addresses, which identify single ATM end systems, or group addresses, which identify one or more ATM end systems. The valid individual and group values of the AFI are given in [Table A5-1 of UNI signalling 4.0](#) [Table A-1 of \[10\]](#). The substructure of the NSAP address (IDP, DSP, ESI, and SEL) is included here for completeness, but is not important to routing operations, [except as specified in Sections 5.2.2.1 and 5.2.3.1](#). For further information on the substructure of ATM End System Addresses, see [\[10\]Section 3.1 of UNI Signalling 4.0](#). Guidelines for assigning ATM Group addresses are provided in [Section 3.3 of \[10\]Annex 5 of UNI Signalling 4.0](#).³

5.2.2 [Address Prefixes](#)³

A prefix of a ATM End System Address is the first “p” bits of that address. The value of p may vary from zero to 152 bits. A prefix with zero length summarizes “all” ATM End System Addresses in one advertisement; PNNI routing will direct calls for which there is no more specific match to systems which advertise such a zero length prefix (i.e. the ‘default’ route). Prefixes with lengths greater than zero and less than 152 are used to summarize some portion of the addressing domain where shorter prefixes summarize greater portions than do longer prefixes (i.e. longer prefixes are more specific).

A set of possible address prefixes are represented in Figure 5-1 by the set of ‘starred’ (****>) arrows. Note that the arrows, like the prefixes, are always applied to the left most bits of an address. The prefix length determines how far these arrows stretch to the right.

PNNI operates in a topologically hierarchical environment. The structure of the hierarchy is defined by the peer group IDs (see Section 5.3.2) used in the routing domain. Address assignment has a hierarchy that should generally correspond to the topological hierarchy, for proper scaling. This allows address summarization where an address prefix represents reachability to all addresses that begin with the stated prefix. Addresses that are exception cases in this general hierarchy are then described by longer prefixes.

[Generally PNNI will advertise reachability to end systems using prefixes on ATM End System Addresses to form summaries. If an end system attached to a node does not fit into one of the node’s configured summaries it will be necessary for the node to make an explicit advertisement for that end system which will necessarily carry a full 152-bit \(all 19-octets\) prefix length. True summaries of end system reachability will have prefix lengths less than 152 bits. Where the addressing hierarchy follows the topological hierarchy, it is possible to advertise reachability to a large number of end systems using a single prefix. Shorter prefixes \(i.e. lower prefix length values\) summarize greater numbers of addresses and vice versa.](#)³

5.2.2.1 [Address Prefixes for AESA Formats with Embedded Addresses](#)³

[There may be a need to calculate routes to end systems which are located in networks supporting E.164 addresses. For this reason, PNNI allows end system reachability to be advertised via prefixes of E.164 addresses using the embedded E.164 AESA format.](#)

[It is desirable that E.164 addresses sharing a common prefix can be summarized by a single advertised reachable address prefix, even when the corresponding set of full E.164 addresses varies in length. Since the embedded E.164 address within each E.164 AESA is right-justified, this is not possible using the traditional E.164 NSAP encoding. For this reason, PNNI 1.1 provides a second encoding of address prefixes for AESA formats with embedded addresses \(e.g. E.164 AESAs and X.121 AESAs\), so that the embedded address is left-justified. This second encoding is specified below. Note that since this encoding is not compatible with the encoding specified in PNNI 1.0, it should only be used in reachable address advertisements when all nodes within a PNNI network are PNNI 1.1 capable.](#)

For all AESA prefixes with AFIs indicating the presence of embedded addresses, address prefixes must be modified from the preferred binary encoding as follows:

- If the end of the address prefix falls within the IDP, each decimal digit in the prefix shall be encoded as the corresponding semi-octet in the range 0000-1001 and no padding characters (i.e. leading semi-octets 0000 in the IDI or trailing semi-octet 1111 in the IDI) shall be inserted, otherwise
- When the address prefix includes bits of the DSP, all leading semi-octets 0000 within the IDI shall be deleted, and instead an equivalent number of semi-octets 1111 shall be inserted at the end of the IDI to pad the IDI out to its original length.

5.2.3 Matching an AESA with an Address Prefix³

An AESA is said to *match* an address prefix when all bits of the address prefix are identical to the corresponding leading bits of the AESA.

Since summaries can enclose other summaries, it is possible that there are many summaries which match, to varying degrees, a given destination address. PNNI route computation will always direct calls to a logical node that is advertising the best match for the given destination that has a wide enough scope for the call. The best match is defined to be the matching (summary) advertisement with the longest prefix.

5.2.3.1 Matching an AESA with an Address Prefix for AESA Formats with Embedded Addresses³

When address prefixes for AESA formats with embedded addresses are transformed as described in Section 5.2.2.1, it is not possible to directly compare AESAs with these address prefixes. The rest of this section describes one method for matching AESAs with address prefixes. Any implementation of a matching process that achieves the same results may be used.

For all AESAs with AFIs indicating the presence of embedded addresses (e.g. E.164 AESAs, X.121 AESAs), before comparing the AESA with address prefixes, the AESA is transformed as follows:

- All leading semi-octets 0000 within the IDI are deleted, and instead an equivalent number of semi-octets 1111 are inserted at the end of the IDI to pad the IDI out to its original length.

The transformed AESA can now be compared directly against address prefixes encoded as described in Section 5.2.2.1. The AESA is said to *match* the address prefix when all bits of the address prefix are identical to the corresponding leading bits of the transformed AESA.

Note that the transformed encoding of the AESA is *not* used in PNNI Signalling. The transformation is only used when determining the longest matching address prefix for a given AESA. Full 20-byte AESAs are always encoded using the preferred binary encoding, as specified in Section 3 of [10].

5.2.4 Node Addresses

Nodes actively taking part in PNNI routing are addressed using ATM End System Addresses.

A single switching system may contain multiple nodes. Each of these nodes requires a unique ATM End System Address. This address is used for establishment of SVCCs used in PNNI. One way for a switching system to generate unique addresses for the nodes it instantiates is by using different values of the selector.

5.2.3 End System Addresses ⁽¹⁾

~~ATM End System Addresses are 20 octets. PNNI routing, as stated above, operates on the first 19 octets. The selector octet is only used to distinguish destinations reachable at the same interface.~~

~~Generally PNNI will advertise reachability to end systems using prefixes on ATM End System Addresses to form summaries. If an end system attached to a node does not fit into one of the node's configured summaries it will be necessary for the node to make an explicit advertisement for that end system which will necessarily carry a full 152-bit (all 19 octets) prefix length. True summaries of end system reachability will have prefix lengths less than 152 bits. Where the addressing hierarchy follows the topological hierarchy, it is possible to advertise reachability to a large number of end systems using a single prefix. Shorter prefixes (i.e. lower prefix length values) summarize greater numbers of addresses and vice versa.~~

~~There may be a need to calculate routes to end systems which are located in networks supporting only E.164 addresses. For this reason, PNNI allows end system reachability to be advertised via prefixes of E.164 addresses using the embedded E.164 NSAP format. Although PNNI has been designed for use in a private ATM network, it is likely that PNNI might also be used internally in public ATM networks, or offered as an external interface to other public and/or private ATM networks.~~

~~Since summaries can enclose other summaries, it is possible that there are many summaries which match, to varying degrees, a given destination address. PNNI route computation will always direct calls to a logical node that is advertising the best match for the given destination that has a wide enough scope for the call. The best match is defined to be the matching (summary) advertisement with the longest prefix.~~

5.3 Identifiers and Indicators

5.3.1 Level Indicators

PNNI entities (nodes, links, and peer groups) occur at various hierarchical levels. The level specifies a bit string length, and ranges from 0 to 104.

Given two entities, where one is an ancestor of the other, the ancestor is a higher-level entity and will have a smaller level indicator than the other. It should be noted that it is not meaningful to directly compare levels for entities where neither is an ancestor of the other.

The level indicator is absolute in the sense that it specifies the exact number of significant bits used for the peer group ID.

PNNI levels are not "dense", in the sense that not all levels will be used in any specific topology. A peer group with an ID of length "n" bits may have a parent peer group whose identifier ranges from 0 to n-1 bits in length. Similarly, a peer group with an ID of length "m" bits may have a child peer group whose identifier ranges anywhere from m+1 to 104 bits in length.

5.3.2 Peer Group Identifiers

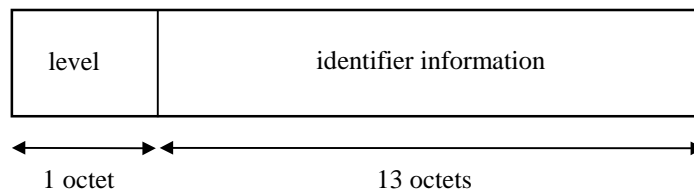

Figure 5-2: Peer Group Identifier 14 octet encoding

¹ Except for the first paragraph (which is deleted), the content of this section has been moved to various places in section 5.2.2

A peer group identifier is a string of bits between zero and 104 bits (13 octets) in length. Peer group identifiers must be prefixes of ATM End System Addresses such that the organization that administers the peer group has assignment authority over that prefix. [When the AESAs use AFIs indicating the presence of embedded addresses \(e.g. E.164 AESAs or X.121 AESAs\), the AESA prefix used to generate the peer group ID should be in the left-justified form as specified in Section 5.2.2.1.](#)³ For example, if an organization is given an n-bit prefix it may assign peer group identifiers with length n or greater, but not less than n.

Peer group identifiers are encoded using 14 octets; a 1 octet (8 bit) level indicator followed by 13 octets (104 bits) of identifier information. The value of the level indicator must be between zero and 104 (bits). The value sent in the identifier information field must be encoded with the 104 - n right-most bits set to zero, where n is the level.

5.3.3 Node Identifiers

The Node Identifier is twenty-two octets in length, and consists of a one octet level indicator followed by a twenty one octet opaque value, i.e., these twenty one octets have no implied internal structure. This opaque value must be unique within the entire routing domain. The level of a node is the same as the level of its containing peer group. A node receiving a node identifier in a PNNI packet must make no other assumptions about the internal structure. Two methods for creating node IDs are currently defined, however other methods of generating node IDs are not precluded.

For nodes which do not represent a peer group:

- the level indicator specifies the level of the node's containing peer group;
- the second octet takes the value 160; This helps distinguish this case from the case below since an encoded peer group ID can not begin with this value.
- the remainder of the node ID contains the twenty-octet ATM End System Address of the system represented by the node. [When the AESA uses an AFI indicating the presence of embedded addresses \(e.g. E.164 AESAs or X.121 AESAs\) and the preferred encoding as specified in 5.2.2.1 is used, the AESA shall be in the left justified form as specified in Section 5.2.2.1.](#)³

For a logical group node which represents a child peer group A.2 in its parent peer group A:

- the level indicator specifies the level of the peer group containing the LGN (i.e., the level of peer group A);
- the next 14 octets are the encoded peer group ID of child peer group A.2.
- the next 6 octets contain the End System Identifier (ESI) of the physical system implementing the logical group node functionality;

Note: The ESI contained in this field allows multiple nodes at the same level to be distinguished in case the lower level peer group is partitioned.

- the last octet of the node ID is zero.

During the operation of the PNNI routing protocol, nodes operating at a particular level will receive PTSPs which include PTSEs from other nodes within their peer group at the same level, and from higher level peer groups. The source node of each PTSP is specified by including the source node ID in each PTSP. Systems implementing PNNI routing are required to accept such incoming packets regardless of the format of the opaque value part of the node ID.

Two PNNI routing packets are from the same node if and only if they contain identical 22-octet source node IDs. For purposes of ordering node IDs the first octet of the node ID is the most significant octet.

The node ID of a node is not allowed to change while the node is operational, i.e. while the node has any adjacencies, hello FSMs in any state other than Down, or any topology database entries.

5.3.4 Port Identifiers and Logical Links

A port ID is a 32 bit number assigned by a node to unambiguously identify a point of attachment of a logical link to that node. Port IDs are only meaningful in the context of the assigning node, identified by its node ID.

The values zero and 0xFFFFFFFF are reserved and may not be used to identify specific ports.

A logical link is identified by the node ID of either node at the end of that link and the port ID assigned by that node.

ATM logical links are duplex having potentially different characteristics in each direction. For links internal to a peer group each end node advertises the port ID and outbound link characteristics. The nodes advertising each end of the link exchange their port IDs with each other. This is accomplished during the exchange of PNNI Hello packets.

For uplinks the advertising border node assigns the local port ID and advertises the link characteristics in both directions along with the upnode's node ID (see Section 5.10.2).

Each advertised link from a node must have a unique port ID within the context of that node.

5.3.5 Aggregation Tokens

An Aggregation Token is a 4 octet identifier. It serves, along with the remote node ID to identify uplinks which are to be aggregated at the next level of the hierarchy. These also serve to bind links of the higher level to those of the next lower level.

The scope of significance of an Aggregation Token is limited to pair-wise logical group nodes. All links between a pair of logical group nodes with the same value of the Aggregation Token must be advertised as one logical link. The same token value may be used between other pairs of nodes without confusion of semantics. However, for ease and flexibility of administration, the space has been chosen to be large enough that globally unique token values can be assigned.

The nodes at each end of an outside link agree on the Aggregation Token advertised in the associated uplinks using the algorithm in Section 5.10.3.1.

The Aggregation Token is included in the PTSEs which describe uplinks as aggregation and binding information. The Aggregation Token is included in the PTSEs which describe Horizontal Links as binding information.

5.3.6 Scope of Addresses

Addresses and address prefixes used in PNNI can have scopes associated with them. Both individual and group addresses have membership scopes, which are used to determine the scope of advertisement of reachable addresses (see Section 5.9.1). For group addresses, scope can also be used for connection scope control, which allows a calling user to constrain a point-to-point connection request using the ATM Anycast capability to group members within a specified level of routing hierarchy (see Sections 5.13, 6.4.5.23, 6.5.2.1, and Annex B).

For PNNI, the scope of reachable addresses is specified by a level indicator. At the UNI, including when using ILMI address registration (in the ILMI object atmAddressOrgMemberScope), the scope may be indicated by one of fifteen levels of organizational scope, as defined in [Annex B of \[10\]-Section A5.2A5.3¹ of UNI Signalling 4.0³](#). A network specific mapping is used to translate between the organizational scope indicated across the UNI and PNNI routing level indicators. The mapping applies to both membership scope, which is passed across the UNI via ILMI address registration and is then advertised with the corresponding reachable address in PTSEs as a PNNI routing level, and to connection scope, which is passed across the UNI in a SETUP message. The mapping shall be a configurable object of the network. The default values for this mapping are as follows:

Table 5-1: Default UNI Scope to PNNI Level Mappings

UNI scope	PNNI Routing Level Indicator
1-3	96
4-5	80
6-7	72
8-10	64
11-12	48
13-14	32
15 (global)	0

5.4 Logical Links

Logical links are an abstract representation of the connectivity between two logical nodes. This includes individual physical links, individual virtual path connections, uplinks, and aggregations of logical links. There may be parallel logical links between two logical nodes. If two lowest-level nodes are connected by a virtual path connection (VPC) which is to be used for PNNI, each of them must know (by configuration/management) that the VPC exists and is to be used for PNNI.

5.5 PNNI Routing Control Channels

PNNI Routing Control Channels (RCCs) are VCCs used for the exchange of PNNI routing protocol packets (Hellos, PTSP, PTSE acks, etc.) between logical nodes that are logically or physically adjacent. There are three cases:

1. For the exchange of the PNNI routing protocol over physical links, a reserved VCC with VPI=0 and VCI=18 will be used.
2. For the exchange of the PNNI routing protocol over a virtual path connection with VPI=V, the PNNI routing protocol exchange will take place over the PNNI VCC within the VPC, that is VPI=V and VCI=18.
3. For the exchange of PNNI routing protocol messages between Logical Group Nodes, an SVCC is established that is dedicated for that purpose and the VPI and VCI are assigned by signalling in the normal way for SVCCs.

5.5.1 Specification of the AAL used by the PNNI Routing Control Channel

This section specifies the ATM adaptation layer (AAL) used by the PNNI routing control channel (RCC). PNNI protocol packets are encapsulated in AAL-Service Data Units (SDU).

The AAL used by the RCC is AAL Type 5 (AAL5). AAL Type 5 is composed of two sublayers, a common part and a service specific part. The Common Part AAL protocol provides unassured information transfer and a mechanism for detecting corruption of AAL SDUs used by the PNNI routing protocol (recovery of corrupted or lost AAL-SDUs is handled by the PNNI routing protocol above the AAL). AAL Type 5 Common Part shall be used to support the PNNI RCC. The AAL Type 5 Common Part Protocol is specified in ITU-T Recommendation I.363. The RCC uses the null Service Specific Convergence Sublayer (SSCS). The null SSCS is described in the AAL Type 5 section of ITU-T Recommendation I.363. [The maximum size of the forward and backward CPCS-SDU of an RCC shall be set to 8192 octets.³](#)

The PNNI RCC is used in Message Mode as described in ITU-T Recommendation I.363. This means that only a complete PNNI packet may be encapsulated in an AAL-SDU. In addition, each AAL-SDU shall contain only one complete PNNI packet.

5.5.2 Traffic Contract for RCCs over Physical Links

The RCC between two lowest level nodes connected via a physical link shall use the following default traffic descriptor:

- Service category is nrt-VBR
- $PCR(CLP=0+1) = RCCPeakCellRate$
- $SCR(CLP=0) = RCCSustainableCellRate$
- $MBS(CLP=0) = RCCMaximumBurstSize$
- Tagging applied.
- Frame discard allowed.

5.5.3 Traffic Contract for RCCs over VPCs

The RCC between two lowest level nodes connected via a VPC shall have by default the same service category as the VPC, and use the following default traffic descriptor:

CBR:

- $PCR = RCCPeakCellRate$

VBR (rt and nrt):

- $PCR = RCCPeakCellRate$
- $SCR = RCCSustainableCellRate$ (Note 1)
- $MBS = RCCMaximumBurstSize$ (Note 1)
- Tagging (Note 2)
- Frame discard allowed.

ABR

- $PCR = PCR$ for VPC
- $MCR = 0.005 * MCR$ for VPC

UBR

- $PCR = PCR$ for VPC

Note 1: The SCR and MBS values apply to the same CLP substream as the SCR parameter of the VPC.

Note 2: When the SCR parameter applies to the CLP=0 substream the default is that tagging is applied. Otherwise the default is that tagging is not applied.

5.5.4 SVCC-Based RCC Connection Establishment Overview

When establishing an SVCC to be used as a PNNI routing control channel, the LGN provides all call setup parameter values necessary for SVCC establishment using local configuration information. When a call is received to establish an RCC, the call setup parameters in the SETUP message may be rejected if the indicated values cannot be supported by this node. However, the values of local PNNI configuration parameters are not considered in making the decision to accept or reject the call. All PNNI implementations are required to support the default values stated below.

The LGN shall request non-real-time VBR service. If that is not available and real-time VBR is available, then that shall be requested in a new connection request. If real-time VBR is not available and CBR is, CBR shall be requested. If CBR is not available and ABR is, ABR shall be requested. If no other service category is available, UBR shall be requested. A service category is considered to be not available either if no route can be found with that service category, or if the call setup with that service category fails due to problems with service category, traffic parameters, or QoS parameters.

The call and connection procedures for SVCC setup are specified in Section 6.5. The following discussion details the content of the SETUP, CONNECT, RELEASE and RELEASE COMPLETE messages specifically for the case of an RCC. If a required information element is not present, the call must be rejected. Note that other information elements described in Section 6.4 of this specification may also be present. The coding standard used is discussed in Section 6.4.5.1 of this document.

5.5.4.1 SETUP Message Contents

5.5.4.1.1 AAL Parameters

The AAL parameters information element (see Section 6.4.5.8) must be used in the SETUP message. Table 5-2 lists the parameters to be used.

Table 5-2: AAL Parameters

Field	Value
AAL Type	5 (for AAL5)
Forward Maximum CPCS-SDU Size	8192 octets.
Backward Maximum CPCS-SDU Size	Same as Forward Maximum CPCS-SDU Size
SSCS Type	0 (Null SSCS)

5.5.4.1.2 ATM Traffic Descriptor

The ATM traffic descriptor information element (see Section 6.4.5.9) must be present. The parameters necessary to establish an RCC are included in the table below. It is possible that the calling end system may wish to create a connection with a different cell rate from the default values given in Table 5-3. In this case the called party may reject the call because it cannot support the requested connection.

When the called party rejects a call based on User-Cell Rate parameters the following actions may be taken by the calling party. If, in response to a SETUP message, a calling LGN receives a RELEASE COMPLETE message, or a CALL PROCEEDING message followed by a RELEASE message, with Cause code (Cause #37, User Cell Rate not available), it may examine the diagnostic field of the Cause I.E. and re-attempt the call after selecting smaller values for the parameter(s) indicated. If the RELEASE COMPLETE or RELEASE message is received with Cause code (Cause #73, Unsupported combination of traffic parameters), it may try other combinations permitted by Section 6.4.5.9.

Table 5-3: ATM User Cell Rate/ATM Traffic Descriptor

Field	Value
Forward Peak Cell Rate (CLP=0+1)	RCCPeakCellRate (for nrt-VBR, rt-VBR, CBR) (note 1)
Forward Sustainable Cell Rate (CLP=0)	RCCSustainableCellRate (for nrt-VBR, rt-VBR)
Forward Maximum Burst Size (CLP=0)	RCCMaximumBurstSize (for nrt-VBR, rt-VBR)
Backward Peak Cell Rate (CLP=0+1)	RCCPeakCellRate (for nrt-VBR, rt-VBR, CBR) (note 1)
Backward Sustainable Cell Rate (CLP=0)	RCCSustainableCellRate (for nrt-VBR, rt-VBR)
Backward Maximum Burst Size (CLP=0)	RCCMaximumBurstSize (for nrt-VBR, rt-VBR)
Best Effort Indicator	(included for UBR only)
Frame Discard Forward	Frame discard allowed (in SETUP message)
Frame Discard Backward	Frame discard allowed (in CONNECT message)
Tagging Forward	Tagging requested (in SETUP message, for nrt-VBR, rt-VBR)
Tagging Backward	Tagging requested (in CONNECT message, if "Tagging supported" was received in SETUP message, for nrt-VBR, rt-VBR)

Note 1 - For ABR and UBR service categories, the default Forward and Backward Peak Cell Rates (CLP=0+1) shall be equal to the line rate.

Note 2 - For the ABR service category for SVCC-based RCCs, the Minimum Cell Rate is set to zero.¹

5.5.4.1.3 Broadband Bearer Capability

This information element (see Section 6.4.5.10) must be used in the SETUP message sent by the calling party. It is used to indicate what kind of network connection is desired. This specification recommends using Service Category non-real time VBR (nrt-VBR). When the calling party receives an indication from the network that Service Category nrt-VBR is not supported via a RELEASE or RELEASE COMPLETE message with cause #57 (bearer capability not authorized), cause #58 (bearer capability not presently available), or cause #65 (bearer capability not implemented), then Service Category rt-VBR must be tried. If that is not available, then Service Category CBR must be tried. If that is not available, then ABR must be tried. If that is not available, the UBR must be tried.

In the signalling message the Service Category is encoded by using the value BCOB-X for Bearer Class and using the values defined for that Service Category in the ATM Transfer Capability field of this information element.

Table 5-4: Broadband Bearer Capability

Field	Value
Bearer Class	BCOB-X
ATM Transfer Capability	Non-real time VBR Real time VBR Constant Bit Rate Available Bit Rate Unspecified Bit Rate
Susceptibility to clipping	0 (Not susceptible to clipping)
User plane connection configuration	0 for point-to-point

Note - UBR is indicated as specified in Tables A9-1 and A9-2 of Annex 9 of the UNI Signalling 4.1 specification using nrt-VBR codepoint with the Best effort indicator set in the ATM traffic descriptor information element.^{1 3}

5.5.4.1.4 Broadband Low Layer Information

This information element (see Section 6.4.5.12) must be used in the SETUP message. It is used to indicate the protocol type carried in the connection. This encoding uses the ATM Forum's allocated 24-bit OUI with the PID indicating the PNNI Routing Control Channel.

Table 5-5: Broadband Low Layer Information

Field	Value
User information layer 3 protocol (octet 7, bits 5-1)	11 (ISO/IEC TR 9577)
ISO/IEC TR 9577 Initial Protocol Identifier (octet 7a, bits 7-1, and octet 7b, bit 7 - spread over two octets, left justified)	0x80 (SNAP Identifier) – octets 7a and 7b are encoded as 0x40 8064 (SNAP Identifier – 0x80, spread over 2 octets, left justified)
Continued from previous Octet	Continued (Ext bit is set to 1)
SNAP ID (octet 8, bits 7-6)	0x80-0 (indicates SNAP and PID follow)
SNAP Organizational Unit Identifier (octets 8.1-8.3)	0x 00 A0 3E (ATM Forum OUI)
PID (octets 8.4-8.5)	0x000A (PNNI PGL to PGL)

The resulting BLLI IE encoding for octet groups 7 and 8 is 0x6B 40 80 80 00 A0 3E 00 0A.³

5.5.4.1.5 QoS Parameter

This information element (see Section 6.4.5.28) must be used in the SETUP message sent by the calling party.

Table 5-6: QoS Parameter

Field	Value
QoS Class Forward	RCCQoSClass
QoS Class Backward	RCCQoSClass

5.5.4.1.6 Extended QoS Parameters

When the service category used for establishment of the PNNI routing control channel is non-real-time VBR, real-time VBR, or CBR, an Extended QoS parameters information element must be included in the SETUP message sent by the calling party. By default no fields shall be included for the Cell loss ratio or Cell delay variation.

Table 5-7: Extended QoS Parameters

Field	Value
Origin	0 (for Originating user) (for nrt-VBR, rt-VBR, CBR)

5.5.4.1.7 End-to-End Transit Delay

By default the End-to-end transit delay information element shall not be included in the SETUP message.

5.5.4.1.8 Called Party Number

This information element (see Section 6.4.5.15) must be used in the SETUP message sent by the calling party. All ATM addresses used to set up the RCC use the ATM Forum UNI ATM End System Address Format of 20 octets.

Table 5-8: Called Party Number (ATM End System Addresses)

Coding Standard	0
I.E. Instruction Field	0
Length of Called Party	20-21 ¹ octets
Type of Number	0 (for Unknown)
Addressing/Numbering Plan	2 (binary 0010) (for ATM end system address)

5.5.4.1.9 Calling Party Number

This information element (see Section 6.4.5.18) must be used in the SETUP message sent by the calling party PNNI.

5.5.4.1.10 Connection Identifier

Normal PNNI signalling procedures for the inclusion of the Connection identifier information element are followed.¹ This information element must be present in the first message returned by the succeeding side (either the CALL PROCEEDING or CONNECT message) and indicates the VPI/VCI value assigned. Optionally, the Preceding side may include the information element in SETUP message to indicate a preferred VPI/VCI value for the connection (see Section 6.4.5.22).¹

5.5.4.1.11 DTL

This information element must be present in the SETUP message sent by the calling party (see Section 6.4.6.4).

5.5.4.2 CONNECT Message Contents

The CONNECT message is formatted by the called party. It is received by the calling party. It is used primarily to confirm the connection.

5.5.4.2.1 AAL Parameters

The called party may include the AAL Parameter information element in the CONNECT message.

If this information element is returned by the network, it should be checked to ensure that the parameters are unchanged or values that can be accepted. If not, the call should be released.

5.5.4.2.2 Broadband Low Layer Information

The called party may include a B-LLI information element in the CONNECT message.

If this information element is returned from the called party, it must be unchanged from the coding requested in the SETUP message. If not, the call must be released.

5.5.4.2.3 Connection Identifier¹

The procedures of Section 6.5 apply.³

This information element indicates what VPI/VCI values have been assigned as specified in Section 6.5.2.2.¹

5.5.4.3 RELEASE and RELEASE COMPLETE Message Contents

PNNI defines the use of the following Cause Codes to indicate why a RCC is being released by a PNNI endpoint. The following encoding is used when explicitly releasing a RCC:

Table 5-9: Cause I.E.

Coding Standard	0	(ITU-TS), used for cause 16 and 31
	3	ATM Forum, used for cause 53
I.E. Instruction Field	0	(not significant)
Location	0	(User)
Cause Value	16	Normal call clearing
	31	Normal, Unspecified
	53	Call Cleared due to change in Peer Group Leader (this is a PNNI-specific cause code; see Section 5.5.6)

5.5.5 SVCCs when One End is not an LGN

After the initial exchange of Hellos, a lowest-level node may find that its neighbor is not in the same peer group, i.e., an outside neighbor. Upon examining the neighbor's nodal hierarchy list (see Section 5.6.2.3), the lowest-level node discovers that it is in the peer group of one of its neighbor's ancestors, i.e., the lowest-level node is a peer with the appropriate LGN as determined from the list.

Under such circumstances, the lowest-level node must be prepared to communicate over an SVCC with the neighboring peer LGN. It must, following the rules for SVCC initiator, either accept or initiate the SVCC. It must then use the procedures specified for operation over an SVCC, as described for SVCCs between logical group nodes. In this situation lowest level nodes may be required to aggregate outside links into horizontal links.

All references in this specification to an SVCC between logical group nodes intrinsically include this case as well.

An example of this is depicted in the following figure. Node A is a lowest-level node, which has outside links to nodes B.1, B.2, and B.3, none of which are in node A's peer group. However, from the nodal hierarchy lists exchanged on these outside links, these nodes discover that node A is a peer of the LGN representing the peer group in which B.1, B.2, and B.3 reside. Therefore an SVCC-based RCC must be established between nodes A and B.

In addition, node A is required to aggregate the outside links into a set of one or more horizontal links depending on the aggregation token values associated with those outside links. For example, assume there are two different aggregation token values being used in the diagram: i) for the links from B.1 to A and B.2 to A, and ii) for the links from B.3 to A. Given these aggregation token values, two horizontal links will be declared between nodes A and B: i) which aggregates the links from B.1 to A and B.2 to A, and ii) which aggregates the links from B.3 to A.

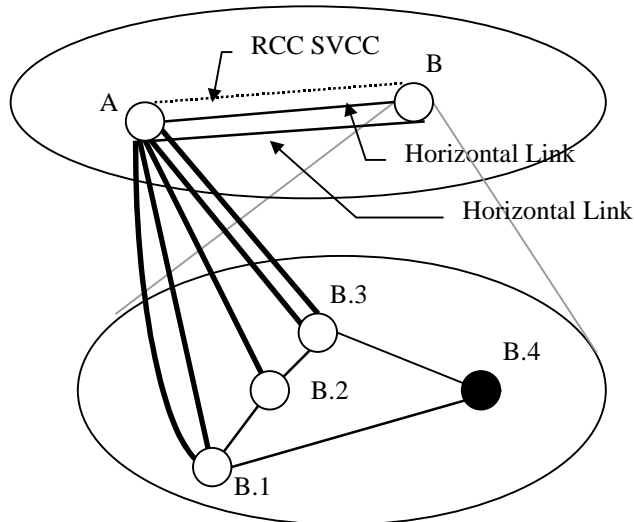

Figure 5-3: An SVCC-Based RCC and horizontal links between a Lowest-Level Node and an LGN.

5.5.6 Establishing and Maintaining SVCCs between Logical Group Nodes

5.5.6.1 SVCC Establishment

The SVCC-based RCCs between neighboring LGNs are established based on information gathered by PNNI.

The SVCC will traverse a border node which is declaring an uplink to the appropriate logical group node. Where there are many border nodes advertising uplinks to the same logical group node, any of the border nodes may be selected.

Each LGN finds out about the address of neighboring LGNs from the uplinks announced by border nodes in the peer groups that the LGN represents. Specifically, the called party address used must be the ATM End System Address for the neighboring LGN at the other end of the uplink which the SVCC is intended to cross, as advertised by the border node. For future flexibility, note that there is no requirement that different border nodes report the same ATM End System Address for the neighboring LGN.

In order to facilitate the routing of the SVCC Setup prior to the advertisement of the horizontal links between the LGNs, special requirements are put on the DTL that the LGN generates. Specifically, the DTL on the bottom of the stack must contain only two Logical Node Ids, that of the LGN that is initiating the SVCC, and that of the LGN that is the target of the SVCC. The Logical Port ID of the initiating LGN is irrelevant. In addition, the Logical Port ID of the last node (i.e., the border node) in all lower DTLs must specify a Logical Port ID that the border node has advertised in an uplink IG to the proper upnode. This Logical Port ID must not be zero.

5.5.6.2 Inconsistent Information and Partitioned Neighbor Peer Groups

Normally there is a single SVCC between a pair of adjacent peer groups. However, in some cases the border nodes within a particular peer group, with links to the same neighboring peer group, may be advertising inconsistent information. Thus, some border nodes may be advertising an uplink to one logical group node (which is alleged to represent a particular neighboring peer group), while other border nodes may be advertising an uplink to a different logical group node (which is alleged to represent the same neighboring peer group).

There are at least two reasons why this situation may occur: (i) The neighboring peer group may be partitioned, for example due to physical link and/or node failures, or (ii) The PGL in the neighboring peer group may have changed, and the border nodes may differ with respect to how rapidly they find out about and advertise this change.

In general, it is not possible to determine which of these situations has occurred. It is therefore necessary to operate with the assumption that the neighboring peer group is partitioned, and therefore to open SVCCs to each alleged neighboring LGN. If in fact there has been a change in the neighboring PGL (and one of the advertisements is out of date), then it will not be possible to actually succeed in opening an SVCC to the corresponding LGN.

5.5.6.3 Detailed Mechanisms for Establishment and Maintenance of SVCCs

The following describes the mechanism executed by a particular logical group node, here called ThisLGN, for setting up SVCCs to neighboring LGNs of ThisLGN.

When an uplink advertisement containing upnode X has reached ThisPGL and is processed by ThisLGN (ThisPGL denotes the peer group leader of ThisLGN's child peer group):

- A.1 If node X is at a higher level than the level of the peer group of ThisLGN, then announce an uplink to X by originating an appropriate PTSE in ThisLGN's peer group.
- A.2 Otherwise, if ThisLGN has an SVCC open to node X, then do nothing.
- A.3 Else, If ThisLGN's node ID is numerically smaller than the node ID of node X, then do nothing.
- A.4 Else, if node X is at a lower level than ThisLGN's peer group, or is at the same level but is in a different peer group than ThisLGN, then an error condition has occurred and nothing should be done. Note that this error condition is likely to occur if ThisLGN's peer group has just changed, ThisPGL has just been elected, or ThisPGL's peer group has just healed a partition. Otherwise this should not occur and indicates an error in the border node advertising the uplink.
- A.5 Else (X is in the same peer group as ThisLGN; there is no SVCC currently open to X, and ThisLGN has the numerically larger node ID): Start timer InitialLGNSVCTimer with value InitialLGNSVCTimeout. Note that this timer must be jittered. When this timer expires, open an inter-LGN SVCC to the ATM address of X.
- A.6 If the SVCC setup attempt succeeds, then use the SVCC as a PNNI Routing Control Channel within ThisLGN's peer group (beginning with exchange of Hellos, and other defined PNNI protocols).

When ThisLGN establishes the SVCC-based RCC, it is the DTL Originator and generates the first DTL:

DTL:[ThisLGN, Node X] pointer-1

The SETUP is then (logically) passed to ThisPGL and it generates the DTL to the border node.

DTL:[ThisPGL, ... BorderNode1] pointer-1

ThisPGL is then responsible for alternate routing when crankback occurs. Given the purpose of this SVCC, all practical routes should be attempted.

If the SVCC setup attempt fails, then start the RetryLGNSVCTimer timer with value RetryLGNSVCTimeout. Note that this timer must be jittered. If a successful SVCC arrives from the same peer LGN (X) while the timer is running, cancel the timer.

If ThisLGN detects the presence of two or more SVCCs to the same neighboring LGN then:

~~If ThisLGN's node ID is numerically smaller than the neighboring LGN's node ID, then ThisLGN shall continue to use all SVCCs. Hello packets must be transmitted on all SVCCs. Database exchange packets and PTSPs may be transmitted on any of the SVCCs. Packets received on any of the SVCCs are acted on independent of which SVCC they were received on. Note that this implies that there is only a single LGN Hello FSM for multiple SVCCs.¹~~

~~B.12~~ If ThisLGN's node ID is numerically larger than the neighboring LGNs node ID, then choose one SVCC to leave open. Close the other SVCC(s) with cause number 16 "normal call clearing".

If ThisPGL ceases to be PGL:

C.1 ~~ThisLGN attempts to flush all of the PTSEs that it originated by transmitting new instances with remaining lifetime ExpiredAge to all neighboring peers in states Exchanging, Loading, or Full. ThisLGN need not wait for PTSE acknowledgements from the neighboring peers before proceeding with the next step and then terminating itself. All PTSEs originated by ThisLGN shall be flushed.¹~~

C.2 ThisLGN clears the SVCCs to all of its neighboring LGNs by sending RELEASE messages with CAUSE IEs indicating cause number 53 "call cleared due to change in PGL".

If an existing SVCC to a neighboring LGN is closed:

D.1 If ThisLGN receives a RELEASE message with cause code number 53 "call cleared due to change in PGL", that relates to a particular SVCC to neighbor node X, then the respective higher level link(s) shall be removed by carrying out the following actions. The event LinkDown shall be triggered in the SVCC-based RCC Hello FSM to upnode X (see Section 5.6.3.1), and the ~~LinkDown-BadNeighbor~~ event shall be triggered in all associated LGN horizontal link Hello FSMs (see Section 5.6.3.2). Start the RetryLGNSVCTimer ~~timer~~¹ with value RetryLGNSVCTimeout.

D.2 Else, if the cause code indicates that the call was cleared due to an ~~signalling~~¹ error, and if upnode X is still being advertised as the destination of uplinks originated by one or more border nodes, and another SVCC is not opened to X, and ThisLGN has a numerically larger node ID than upnode X, then attempt to re-establish this SVCC to upnode X immediately and go to Step A.6.

~~D.3 Else, if upnode X is still being advertised as the destination of uplinks originated by one or more border nodes, and another SVCC is not opened to X, and this LGN has a numerically larger node ID than upnode X, then start the RetryLGNSVCTimer with initial value RetryLGNSVCTimeout.¹~~

~~D.4~~ Otherwise do nothing.¹

If the RetryLGNSVCTimer expires:

E.1. If the upnode X is still being advertised as the destination of uplinks originated by one or more border nodes, and if X is in the same peer group as ThisLGN, there is no SVCC currently open to X, and ThisLGN has the numerically larger node ID, then retry an SVCC setup to X and go to step A.6.

E.2. Otherwise do nothing.

Note: The failure of an SVCC between neighboring LGNs may be caused by failure of a single component internal to either of the neighboring peer groups. This does not necessarily imply any significant loss of connectivity between peer groups. Thus, if the SVCC fails this MUST NOT have any immediate effect on announcement of the corresponding higher level link between logical group nodes. Rather, there must be an attempt to re-establish the SVCC prior to changing the announced status of the link.

See Section 5.6.3 for further details.

5.6 The Hello Protocol

PNNI Hello packets are exchanged between neighbor nodes. This is done over RCCs.

Hellos are sent over all physical links and VPCs in order to discover and verify the identity of neighbor nodes and to determine the status of the links to those nodes.

In addition, Hellos are also sent over all SVCCs used as RCCs. These Hellos are used to verify the identity of the neighbor node, the status of the horizontal links to that node, and to determine the status of the RCC.

References to the hello data structures that appear in the Hello FSM refer to the hello data structures described in the appropriate sections (see Sections 5.6.2.1.1, 5.6.3.1.1, 5.6.3.2.1) based on the contexts.

5.6.1 PNNI Version Negotiation

A PNNI implementation generally supports a range of protocol versions. In protocol messages, version fields are unsigned integers. A node indicates by the 'newest' and 'oldest' version supported fields in all packets the range of supportable versions. All versions in this range are supported by the advertiser. An additional field, the 'protocol version', contains the version used to produce the packet. Once negotiation has taken place, this will reflect the result of that negotiation. This negotiation consists of using the lower of the highest locally supportable version, and the highest version supportable by the neighbor. This negotiation is only done as part of the Hello FSM. If that version is not locally supportable, the adjacency can not be started, and management should be notified. The explicit 'oldest' supported version field can be used by the other side to detect this incompatibility, so that it may also notify management of the problem.

5.6.2 Hellos Over Physical Links and VPCs

5.6.2.1 The Hello State Machine

Between two lowest-level neighbor nodes each physical link or VPC has its own instance of the hello protocol. An instance of the hello protocol is made up of a hello data structure and a Hello state machine.

For lowest-level neighbor nodes with parallel physical links and/or VPCs between them, there will be multiple instances of the Hello protocol. However, for the purposes of database synchronization and flooding of PTSEs, there is only one instance of the neighboring peer data structure and associated neighboring peer state machine. In order to describe the interaction between the multiple Hello conversations and the single neighboring peer conversation (for database synchronization and flooding procedures), reference is made to a neighboring peer state machine and to its events AddPort and DropPort. The event AddPort indicates that a new inside link to the neighboring peer node has come up (i.e., has reached the Hello state 2-Way Inside). The event DropPort indicates that a link to the neighboring peer has gone down (i.e., has fallen out of the Hello state 2-Way Inside). The description of the Hello state machine includes indication of when the events AddPort and DropPort must be triggered, thus describing the interaction between the multiple Hello conversations and the corresponding neighboring peer conversation.

5.6.2.1.1 The Hello Data Structure

There is a single hello data structure for each of this node's physical ports and for each logical port (each Virtual Path Connection for which this node is an endpoint).

Each hello data structure consists of the following items:

State

The operational status of a link. This is described in more detail in Section 5.6.2.1.2.

Port ID

A number assigned by the node that identifies which physical port and which virtual path connection, if any, is described by this hello data structure.

Remote Node ID

The Node ID of the neighbor node on the other end of the link. The Remote Node ID is learned when Hellos are received from the neighbor.

Remote Peer Group ID

The peer group ID of the neighbor node on the other end of the link. The Remote Peer Group ID is learned when Hellos are received from the neighbor.

Remote Port ID

The neighbor's port ID for this link. The Remote Port ID is learned when Hellos are received from the neighbor. When the Remote Port ID is not known, its value must be set to zero.

HelloInterval

The amount of time, in seconds, between Hellos that the node sends out over this link, in the absence of event-triggered Hellos.

Hello Timer

An interval timer that fires every HelloInterval seconds. Whenever the timer fires, the node transmits a Hello over this link.

InactivityFactor

The amount of time, in multiples of the HelloInterval declared by the neighbor in its Hellos, before the node will consider the link down, if the neighbor's Hellos cease to arrive.

Inactivity Timer

A single shot timer whose firing indicates that no Hellos have been received from this neighbor recently. The initial value of the Inactivity Timer must be set to the InactivityFactor times the HelloInterval from the most recent Hello received from the neighbor node.

Version

The current version of the Hello protocol being used for communication with this neighbor. If no acceptable version number has been derived, this field will be zero.

For outside links (i.e., links to nodes in other peer groups) the following additional items are included:

Transmitted ULIA Sequence Number

The sequence number from the most recently transmitted ULIA.

Received ULIA Sequence Number

The sequence number from the most recently received ULIA or cleared if the last received hello did not contain the ULIA.

Received Nodal Hierarchy Sequence Number

The sequence number from the most recently received nodal hierarchy list or cleared if the last received hello did not contain a nodal hierarchy list.

Upnode Node ID

The node ID of the upnode. The Upnode Node ID is learned when Hellos containing a sufficiently complete nodal hierarchy list are received from the neighbor node.

Common Peer Group ID

The peer group ID of the common peer group of the border node and its outside neighbor. The Common Peer Group ID is learned when Hellos containing a sufficiently complete nodal hierarchy list are received from the neighbor node.

Upnode ATM End System Address

The ATM End System Address of the upnode. The Upnode ATM End System Address is learned when Hellos containing a sufficiently complete nodal hierarchy list are received from the neighbor node.

Derived Link Aggregation Token

The algorithmically derived value of the link aggregation token for this link.

Configured Link Aggregation Token

This node's configured link aggregation token for this link.

Remote Link Aggregation Token

The link aggregation token received in Hellos from the neighbor at the other end of the link.

5.6.2.1.2 Hello States

The states that Hello FSM may attain are described in this section. Figure 5-4 shows a diagram of the possible state changes. The arcs are labeled with the events that cause each state change. These events are described in Section 5.6.2.1.3. For a detailed description of the state changes and the actions involved with each state change, see Section 5.6.2.1.4.

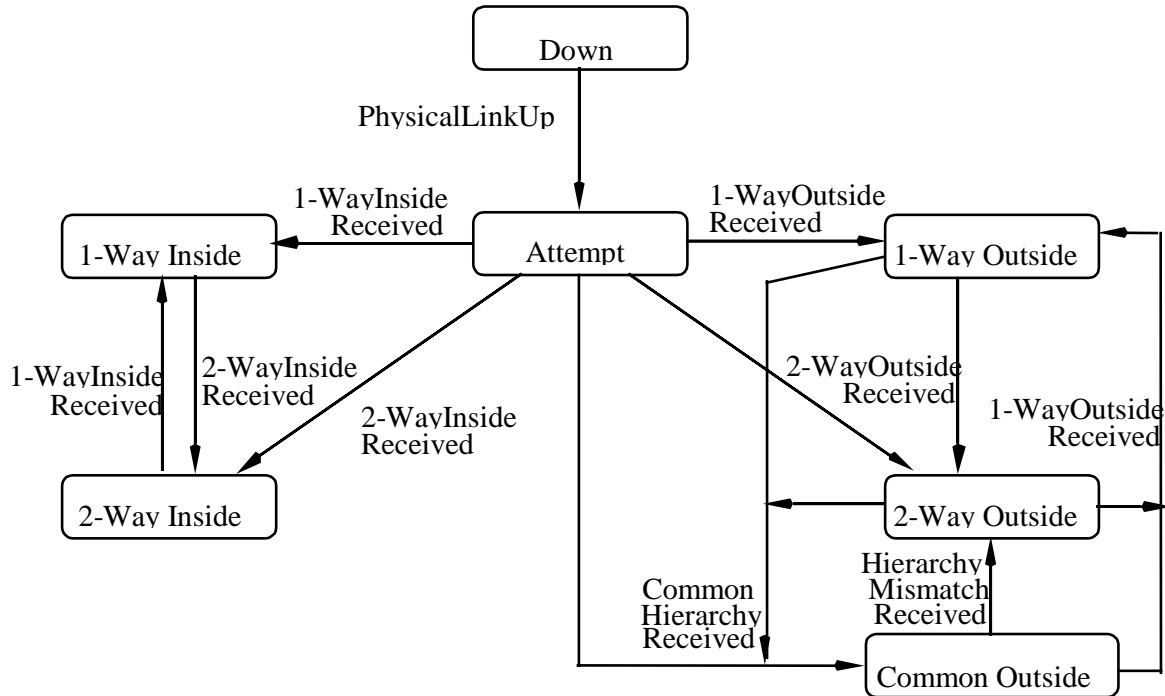

In addition to the state transitions pictured,

- Event LinkDown always forces Down State,
- Event InactivityTimer always forces Attempt State,
- Event HelloMismatchReceived always forces Attempt State.

Figure 5-4: Hello State Changes

Down

The initial state of the Hello FSM. This state is also reached when lower-level protocols have indicated that the link is not usable. No PNNI routing packets will be sent or received over such a link.

Attempt

This state indicates that either no Hellos or Hellos with mismatch information have been received recently from the neighbor. In this state, attempts are made to contact the neighbor by periodically sending the neighbor Hellos with period HelloInterval.

1-Way Inside

In this state, Hellos have recently been received from the neighbor and it has been established that both nodes are members of the same peer group, but the remote node ID and remote port ID in the neighbor's Hellos were set to zero.

2-Way Inside

In this state, Hellos have recently been received from the neighbor indicating that both nodes are members of the same peer group and including the correct remote node ID and remote port ID fields. When this state is reached, it indicates that bi-directional communication over this link between the two nodes has been achieved. Database summary packets, PTSE Request packets, PTSPs, and PTSE acknowledgment packets can only be transmitted over links that are in the 2-Way Inside state. For physical links and VPCs, only those links that are in the 2-Way Inside state can be advertised by this node in PTSEs as horizontal links.

1-Way Outside

This state indicates that Hellos have recently been received from the neighbor and that the neighbor node belongs to a different peer group, but the remote node ID and remote port ID in the neighbor's Hellos were set to zero. In this state and in the 2-Way Outside state, the node searches for a common peer group that contains both this node and the neighbor node.

2-Way Outside

In this state, Hellos have recently been received from the neighbor indicating that the neighbor node belongs to a different peer group and including the correct remote node ID and remote port ID fields, but with a nodal hierarchy list that does not include any common peer group. In this state and in the 1-Way Outside state, the node searches for a common peer group that contains both this node and the neighbor node.

Common Outside

When this state is reached, it indicates that a common level of the routing hierarchy has been found, in addition to achieving full bi-directional communication between the two nodes. Links that have reached the Common Outside state can be advertised in PTSEs as uplinks to the upnode.

5.6.2.1.3 Events causing Hello state changes

State changes can be brought about by several possible events associated with operation of the Hello protocol. These events are shown as the labeled arcs in Figure 5-4. A detailed explanation of the state changes and actions taken after an event occurs is given in Section 5.6.2.1.4.

LinkUp

Lower layer protocols have indicated that the link is operational. If autoconfiguration is enabled for the link, the LinkUp event is generated when the ILMI autoconfiguration has completed with an ATM interface type of Private NNI.

1-WayInsideReceived

A Hello has been received from the neighbor in which the Peer Group ID matches the Peer Group ID of this node and Remote Node ID and Remote Port ID are set to zero. Additionally, if the Version, Remote Node ID, Remote Port ID and Remote Peer Group ID fields in the hello data structure are not equal to zero, they must match, respectively, the Protocol Version, Node ID of Source, Port ID and Peer Group ID from the received Hello.

2-WayInsideReceived

A Hello has been received from the neighbor in which the Remote Node ID and Remote Port ID correctly identify this node's Node ID and this Port ID, and the Peer Group ID matches this node's Peer Group ID. Additionally, if the Version, Remote Node ID, Remote Port ID and Remote Peer Group ID fields in the hello data structure are not equal to zero, they must match, respectively, the Protocol Version, Node ID of Source, Port ID and Peer Group ID from the received Hello.

1-WayOutsideReceived

A Hello has been received from the neighbor including a Peer Group ID that does not match this node's own Peer Group ID, and with Remote Node ID and Remote Port ID fields that are set to zero. Additionally, if the Version, Remote Node ID, Remote Port ID and Remote Peer Group ID fields in the hello data structure are not equal to zero, they must match, respectively, the Protocol Version, Node ID of Source, Port ID and Peer Group ID from the received Hello.

2-WayOutsideReceived

A Hello has been received from the neighbor including:

- (i) Remote Node ID and Remote Port ID fields that correctly reflect this node's Node ID and Port ID for this link, and
- (ii) a Peer Group ID that does not match this node's own Peer Group ID, and
- (iii) the Common Peer Group ID, the Upnode Node ID and Upnode ATM End System Address in the hello data structure are set to zero, and
- (iv) one of the following is true:

A - Either the nodal hierarchy list, aggregation token or ULIA is not present

B - the nodal hierarchy list is present but does not contain a common peer group.

Additionally, if the Version, Remote Node ID, Remote Port ID and Remote Peer Group ID fields in the hello data structure are not equal to zero, they must match, respectively, the Protocol Version, Node ID of Source, Port ID and Peer Group ID from the received Hello.

CommonHierarchyReceived

A Hello has been received from the neighbor including:

- (i) Remote Node ID and Remote Port ID fields that correctly reflect this node's Node ID and Port ID for this link, and
- (ii) a Peer Group ID that does not match this node's own Peer Group ID, and
- (iii) a ULIA, and
- (iv) an Aggregation token, and
- (v) a nodal hierarchy list containing either:

- a sequence number that matches the received Nodal Hierarchy Sequence Number, and the Common Peer Group ID has already been set in the hello data structure, or

- a common peer group; and the Common Peer Group ID, the Upnode Node ID and Upnode ATM End System Address in the hello data structure are set to zero or these fields match, respectively, the lowest common peer group in the received nodal hierarchy list and the Node ID and ATM End System Address associated with that common Peer Group ID.

Additionally, if the Version, Remote Node ID, Remote Port ID and Remote Peer Group ID fields in the hello data structure are not equal to zero, they must match, respectively, the Protocol Version, Node ID of Source, Port ID and Peer Group ID from the received Hello.

HelloMismatchReceived

A Hello has been received from the neighbor in which at least one of the Version, ~~Originating-Node ID of Source~~, Peer Group ID, and Port ID is different from the Protocol Version, Remote Node ID, Remote Peer Group ID, or Remote Port ID, respectively, in the hello data structure, or a Hello has been received from the neighbor in which Node ID of Source is equal to this node's Node ID.³

Alternatively, a Hello has been received in which the Remote Node ID and/or Remote Port ID are different from this node's own Node ID or this node's Port ID for the receiving link, respectively, and are not both set to zero. In the state Attempt, only the second alternative is considered. The HelloMismatchReceived event takes precedence over the other events.

HierarchyMismatchReceived

A Hello has been received from the neighbor that:

- (i) includes a Remote Node ID and Remote Port ID fields that correctly reflect this node's Node ID and Port ID for this link, and
- (ii) includes a Peer Group ID that does not match this node's own Peer Group ID, and
- (iii) does not meet the criteria for HelloMismatchReceived, and
- (iv) either:
 - there is no nodal hierarchy list, or
 - no ULIA is found, or
 - no aggregation token is found, or
 - a new nodal hierarchy list sequence number has been received and either
 - the sequence of peer group levels is not strictly descending in value, or
 - no common peer group is found, or
 - the lowest common Peer Group ID found is different from the Common Peer Group ID in the hello data structure, or
 - in the information triple that includes the Common Peer Group ID, a higher level node ID and/or higher level ATM End System Address that does not match the Upnode Node ID or Upnode ATM End System Address in the hello data structure, respectively.

HelloTimerExpired

The Hello Timer has expired.

InactivityTimerExpired

The Inactivity Timer has expired. This means that no Hellos have been received recently from the neighbor.

LinkDown

Lower layer protocols indicate that this link is not usable. If ILMI autoconfiguration completes with an ATM interface type not equal to Private NNI, a LinkDown event is generated. Note that the loss of ILMI connectivity does not generate any event.

5.6.2.1.4 Description of The Hello State Machine

The finite state machine is a two dimensional table with States across the top of the table and the Events down the left side. Each pairing of event and state cross at a "cell" in the table. The cell shows what state transition occurs and the action to take. For example, for the event and state pair of "LinkUp" and "Down" the cell reads "Hp1, Attempt". "Attempt" is the new state and "Hp1" is the Action to be taken. The actions definitions can be found following table.

Table 5-10: Hello FSM

<i>Events</i>	<i>States</i>						
	Down	Attempt	1-Way Inside	2-Way Inside	1-Way Outside	2-Way Outside	Common Outside
Link Up	Hp1, Attempt	Hp0, Attempt	Hp0, 1WayIn	Hp0, 2WayIn	Hp0, 1WayOut	Hp0, 2WayOut	Hp0, Common
1-Way Inside Received	Hp0, Down	Hp2, 1WayIn	Hp12, 1WayIn	Hp10, 1WayIn	FSM_Err	FSM_Err	FSM_Err
2-Way Inside Received	FSM_Err	Hp3, 2WayIn	Hp4, 2WayIn	Hp12, 2WayIn	FSM_Err	FSM_Err	FSM_Err
1-Way Outside Received	Hp0, Down	Hp5, 1WayOut (Note 1)	FSM_Err	FSM_Err	Hp12, 1WayOut	Hp13, 1WayOut	Hp14, 1WayOut
2-Way Outside Received	FSM_Err	Hp5, 2WayOut (Note 1)	FSM_Err	FSM_Err	Hp12, 2WayOut	Hp12, 2WayOut	FSM_Err
Common Hierarchy Received	FSM_Err	Hp6, Common (Note 1)	FSM_Err	FSM_Err	Hp7, Common	Hp7, Common	Hp20, Common
Hello Mismatch Received	FSM_Err	Hp0, Attempt	Hp8, Attempt	Hp16, Attempt	Hp8, Attempt	Hp8, Attempt	Hp17, Attempt
Hierarchy Mismatch Received	FSM_Err	FSM_Err	FSM_Err	FSM_Err	FSM_Err	FSM_Err	Hp11, 2WayOut
Hello Timer Expired	FSM_Err	Hp15, Attempt	Hp15, 1WayIn	Hp15, 2WayIn	Hp15, 1WayOut	Hp15, 2WayOut	Hp15, Common
Inactivity Timer Expired	FSM_Err	FSM_Err	Hp8, Attempt	Hp16, Attempt	Hp8, Attempt	Hp8, Attempt	Hp17, Attempt
Link Down	Hp0, Down	Hp9, Down	Hp9, Down	Hp18, Down	Hp9, Down	Hp9, Down	Hp19, Down

Note 1: Nodes that are not capable of becoming border nodes must use action Hp0 and remain in the Attempt state.

FSM_ERR Represents an internal implementation error.

Hp0

Action: Do nothing.

Hp1

Action: Send a Hello out over the link and start the Hello Timer, enabling the periodic sending of Hellos.

Hp2

Action: Start the Inactivity Timer for the link. Set the Remote Node ID, Remote Peer Group ID, and Remote Port ID in the hello data structure to the Node ID, Peer Group ID, and Port ID listed in the received Hello. Calculate the lower of the received newest version supported and the local newest version supported. Record this as the Version number. Send a Hello to the neighbor and restart the Hello Timer.

Hp3

Action: Start the Inactivity Timer for the link. Set the Remote Node ID, Remote Peer Group ID, and Remote Port ID in the hello data structure to the Node ID, Peer Group ID, and Port ID listed in the received Hello. Calculate the lower of the received newest version supported and the local newest version supported. Record this as the Version number. Send a Hello to the neighbor and restart the Hello Timer. Invoke the corresponding neighboring peer state machine with the event AddPort.

Hp4

Action: Restart the Inactivity Timer. Invoke the corresponding neighboring peer state machine with the event AddPort.

Hp5

Action: Start the Inactivity Timer for the link. Set the Remote Node ID, Remote Peer Group ID, and Remote Port ID in the hello data structure to the Node ID, Peer Group ID, and Port ID listed in the received Hello. Calculate the lower of the received newest version supported and the local newest version supported. Record this as the Version number. Send a Hello to the neighbor including a nodal hierarchy list and all outgoing service category metrics information groups describing this link, and restart the Hello Timer.

Hp6

Action: Start the Inactivity Timer for the link. Set the Remote Node ID, Remote Peer Group ID, and Remote Port ID in the hello data structure to the Node ID, Peer Group ID, and Port ID listed in the received Hello. Find the lowest common peer group in the nodal hierarchy list received in the neighbor's Hello and in this node's own nodal hierarchy list, and set the Upnode Node ID, Common Peer Group ID, and Upnode ATM End System Address to the values contained in the corresponding information triple from the received nodal hierarchy list. Calculate the lower of the received newest version supported and the local newest version supported. Record this as the Version number. Send a Hello to the neighbor including a nodal hierarchy list and all outgoing ULIA's describing this link, and restart the Hello Timer. The link may now be advertised by this node in PTSEs as an uplink to the upnode.

Hp7

Action: Restart the Inactivity Timer, since a Hello has been seen from the neighbor. Find the lowest common per group in the nodal hierarchy list received in the neighbor's Hello and in this node's own nodal hierarchy list, and set the Upnode Node ID, Common Peer Group ID, and Upnode ATM End System Address to the values contained in the corresponding information triple from the received nodal hierarchy list. The link may now be advertised by this node in PTSEs as an uplink to the upnode.

Hp8

Action: The Inactivity Timer is disabled and the Version, remote node ID, remote peer group ID, remote port ID, Upnode ID, common peer group ID, Upnode ATM End System Address fields, Received ULIA Sequence Number and the Received Nodal Hierarchy Sequence Number in the hello data structure are cleared. Send a Hello to the neighbor and restart the Hello Timer.

Hp9

Action: The Hello and Inactivity timers are disabled and the Version, remote node ID, remote peer group ID, remote port ID, Upnode Node ID, common peer group ID, Upnode ATM End System Address, Received ULIA Sequence Number and the Received Nodal Hierarchy Sequence Number fields in the hello data structure are cleared.

Hp10

Action: Restart the Inactivity Timer. Send a Hello to the neighbor and restart the Hello Timer. Invoke the neighboring peer state machine with the event DropPort.

Hp11

Action: Restart the Inactivity Timer. The Upnode ID, common peer group ID and Upnode ATM End System Address fields in the hello data structure are cleared. This link must be removed from any PTSEs originated by this node in which it has been advertised as an uplink

Hp12

Action: Restart the Inactivity Timer for the link since a Hello has been received from the neighbor.

Hp13

Action: Restart the Inactivity Timer. Clear the Received ULIA Sequence Number and the Received Nodal Hierarchy Sequence Number from the Hello data structure. Send a Hello to the neighbor including a nodal hierarchy list and all outgoing ULIAs describing this link, and restart the Hello Timer.

Hp14

Action: Restart the Inactivity Timer. The Upnode ID, common peer group ID, Upnode ATM End System Address fields, Received ULIA Sequence Number and the Received Nodal Hierarchy Sequence Number in the hello data structure are cleared. Send a Hello to the neighbor including a nodal hierarchy list and all outgoing ULIAs describing this link, and restart the Hello timer. This link must be removed from any PTSEs originated by this node in which it has been advertised as an uplink.

Hp15

Action: Send a Hello to the neighbor and restart the Hello Timer.

Hp16

Action: The Inactivity Timer is disabled and the Version, remote node ID, remote peer group ID, remote port ID, Upnode ID, common peer group ID, Upnode ATM End System Address fields, Received ULIA Sequence Number and the Received Nodal Hierarchy Sequence Number in the hello data structure are cleared. Send a Hello to the neighbor and restart the Hello Timer. The neighboring peer state machine must be invoked with the event DropPort.

Hp17

Action: The Inactivity Timer is disabled and the Version, remote node ID, remote peer group ID, remote port ID, Upnode ID, common peer group ID, Upnode ATM End System Address fields, Received ULIA Sequence Number and the Received Nodal Hierarchy Sequence Number in the hello data structure are cleared. Send a Hello to the neighbor and restart the Hello Timer. This link must be removed from any PTSEs originated by this node in which it has been advertised as an uplink.

Hp18

Action: The Hello and Inactivity timers are disabled and the Version, remote node ID, remote peer group ID, remote port ID, Upnode Node ID, common peer group ID, Upnode ATM End System Address, Received ULIA Sequence Number and the Received Nodal Hierarchy Sequence Number fields in the hello data structure are cleared. The neighboring peer state machine must be invoked with the event DropPort.

Hp19

Action: The Hello and Inactivity timers are disabled and the Version, remote node ID, remote peer group ID, remote port ID, Upnode Node ID, common peer group ID, Upnode ATM End System Address, Received ULIA Sequence Number and the Received Nodal Hierarchy Sequence Number fields in the hello data structure are cleared. This link must be removed from any PTSEs originated by this node in which it has been advertised as an uplink.

Hp20

Action: Restart the Inactivity Timer. If the ULIA sequence number does not match the received ULIA Sequence Number in the hello data structure, then the uplink advertisement corresponding to this link must be updated with the received ULIA and re-originated immediately (subject to PTSE holddown).

5.6.2.2 Sending Hellos

Hellos are sent over each link in order to establish that bi-directional communication has been achieved. When the Version field of the hello data structure is zero, Hellos are sent encoded according to the newest version supported by this implementation. Otherwise the recorded Version is used. In either case, the version used is encoded in the Protocol Version field of the Hello packet.

In all states other than Down, Hellos are transmitted periodically, every HelloInterval seconds. In addition, event-triggered Hellos are sent in the following cases (subject to the hold-down timer):

- Upon every state change except the following:
 - 1-Way Inside to 2-Way Inside,
 - 1-Way Outside to 2-Way Outside,
 - 1-Way Outside to Common Outside,
 - 2-Way Outside to Common Outside, and
 - Common Outside to 2-Way Outside.
- On an outside link, whenever a significant change occurs in the ULIA for this outside link.
- On an outside link, whenever a change occurs in the node's nodal hierarchy list.
- On an outside link, whenever a change occurs in the link aggregation token for this outside link.

The period between successive transmission of Hellos may not be less than MinHelloInterval. The use of a hold-down timer prevents a node from sending Hellos at unacceptably high rates. If multiple event triggered hellos are deferred because of the hold down timer, then only one hello is transmitted containing the most current information for all IGs when the hold down timer expires. Whenever event-triggered Hellos are transmitted, the Hello Timer is restarted so that the next Hello is scheduled after HelloInterval seconds subject to the usual jitter.

When the Hello state is Attempt, Hellos must have their remote node ID and remote port ID fields set to zero as stored in the hello data structure. When the Hello state is 1-Way Inside, 2-Way Inside, 1-Way Outside, 2-Way Outside, or Common Outside, Hellos must include as the remote node ID and the remote port ID the neighbor node's node ID and port ID, as learned from the Hellos received over the same link and stored in the hello data structure.

The nodal hierarchy list, describing all of the node's higher level node IDs, peer group IDs, and LGN ATM End System Addresses as received from the PGL in its Higher Level Binding information, is included in Hellos when the state is 1-Way Outside, 2-Way Outside, or Common Outside. If multiple nodes claim to be peer group leader of this peer group, advertise the information from the one chosen locally as peer group leader. For higher-level peer groups, if multiple nodes claim to be PGL, advertise the information from the one selected by the ancestor LGN in that peer group.

Whenever a change occurs in the number or content of known higher levels, as expressed in the nodal hierarchy list, the sequence number of the nodal hierarchy list must be incremented and an event-triggered Hello must be sent. Additionally, whenever a change occurs in the node ID, peer group ID, or ATM address at the lowest level, the sequence number of the nodal hierarchy list must be incremented and an event-triggered Hello must be sent. When sending the first instance of the nodal hierarchy list to any neighbor, the value of the sequence number must be greater than zero.

Each time a Hello is transmitted including the nodal hierarchy list, the list must include all higher levels that are known at that time. If no higher levels of hierarchy are known, then an empty nodal hierarchy list must be included. Note that when the hierarchy is still coming up, the number of levels included in the nodal hierarchy list may increase with each successive Hello.

A ULIA IG that encompasses all outgoing Resource Availability IGs is included in Hellos when the state is either 1-WayOutside, 2-WayOutside or CommonOutside.

The Configured Link Aggregation Token, which is used to identify uplinks that may be aggregated to a particular induced uplink or a particular horizontal link, is included in Hellos when the state is either 1-WayOutside, 2-WayOutside or CommonOutside.

5.6.2.2.1 Originating and sending ULIA in Hellos on Outside Links

For certain Hello states, a border node must include a ULIA IG in the Hello packets it sends on each outside link to neighboring border nodes. The ULIA itself does not specify any link state information, but rather is used to bundle other IGs which do. The flexibility provided by this mechanism allows a border node to dictate the exact link state information (IGs) advertised by its neighbor without requiring the neighbor to understand or interpret the individual IGs. In this fashion, portions of the network can be upgraded (e.g. to provide new security or policy features in new and unknown IGs), and have the correct link state information advertised throughout the hierarchy.

Significant change in the ULIA contents is indicated by a change to the ULIA sequence number. The originator only increments the ULIA sequence number when the change to the ULIA contents is significant.

Since the border nodes do not interpret the individual IGs within ULIA received in Hello packets, any change to the ULIA sequence number indicates a significant change, and must therefore trigger an update to the corresponding uplink PTSE. Re-origination of a new instance of an uplink PTSE in response to this triggered update is subject to the PTSE hold down timer.

A border node must not generate new sequence numbers for the ULIA it is sending in Hellos unless a significant change has occurred for one or more of the IGs contained in the ULIA. If no significant change has occurred since the last ULIA was sent in a Hello packet, then the (possibly modified) ULIA with the previous sequence number must continue to be sent in Hellos. Any insignificant changes to the bundled IGs by definition is not important enough to incur the processing expense of propagating the change hierarchically and therefore must not carry a change in the sequence number. Whenever a new ULIA is formed in response to a significant change, the sequence number must be incremented.

A significant change event for any IG that was previously bundled into a ULIA and sent in a Hello packet triggers the building of a new ULIA, and the sending of a new Hello packet to the corresponding outside neighbor. When the new Hello packet is sent, it will include the new ULIA and new sequence number. When forming the new ULIA in response to a significant change to one or more of the bundled IGs, the border node inserts the most recent and accurate link state information for all bundled IGs, whether significant change has occurred for them or not. In this way, a significant change to any one IG causes the latest information for all IGs bundled in the same ULIA to be advertised.

5.6.2.3 Receiving Hellos

If a Hello is received with a Protocol Version that is not supported, the packet must be discarded. If the range of supported versions indicated in the Hello packet does not overlap with the range of supported versions of this node, a management notification may be logged. See Section 5.1.3.

If a Hello is received with a top level unknown TLV with the mandatory tag bit set, the hello must be discarded. In addition, if either the Hello Interval or Port ID in the received hello packet is set to zero, the packet is also invalid and must be discarded.

The neighbor node is identified by the node ID found in the Hello's header. If the Remote Node ID, Remote Peer Group ID, and Remote Port ID in the hello data structure have not yet been specified, then they must be set to the received Hello's originating node ID, peer group ID, and port ID, respectively. If the Version field in the hello data structure is zero, calculate the lower of the received newest version supported and the local newest version supported. Record this as the Version number.

If the received Hello contains a new instance of the nodal hierarchy list, as indicated by a new sequence number, then the nodal hierarchy list must be searched for the lowest level peer group that both nodes have in common. Note that the neighbor's node ID, peer group ID, and ATM End System Address must be considered logically to be the lowest level component of the nodal hierarchy list, even though it does not explicitly appear in the list.

If a node finds a match with its own peer group ID, there is no uplink (see Section 5.5.5). Rather this node will become a neighboring peer of the LGN representing the neighbor border node in the common peer group. An SVCC will be established and one or more horizontal links will be advertised as detailed in Section 5.5.6.

The received aggregation token is processed as described in Section 5.10.3.1.

Each received Hello causes the Hello state machine to be executed with one of the following events, depending on the contents of the received Hello:

- 1-WayInsideReceived
- 2-WayInsideReceived
- 1-WayOutsideReceived
- 2-WayOutsideReceived
- CommonHierarchyReceived
- HelloMismatchReceived
- HierarchyMismatchReceived

5.6.2.3.1 Processing ULIA received in Hellos on outside links

When a border node receives a Hello packet from a neighboring border node on an outside link, it must determine whether to (re-)originate the corresponding uplink PTSE. No change to the uplink PTSE need be made if the sequence number for the ULIA received in the most recent Hello packet is the same as that received with the previous ULIA (in the previous Hello packet). The sequence number comparison at the receiver is used to determine whether significant change to the contained link state information IGs has occurred. Any change in the ULIA sequence number field when compared with the previously received ULIA sequence number constitutes a significant change that, subject to hold down, will cause the receiver to re-originate the corresponding uplink PTSE. Note that if the uplink advertisement is re-originated for other reasons, the most recently received ULIA must be used in composing it.

5.6.3 The LGN Hello Protocol

In the following discussion, we refer to Logical Group Node neighbors, and do so for the ease of reading the text (see Section 5.5.5). It must be noted however, that when the hierarchy has unequal depths it is possible that a lowest level border node is peer to a LGN. In that case an SVCC will exist between that border node and the LGN, and all of the following text applies.

The Hello protocol between LGNs serves two purposes. One is to monitor the status of the SVCC used as a PNNI routing control channel between the two LGNs to increase robustness. The second is to communicate and agree upon the horizontal links which they will mutually advertise.

SVCCs will often traverse multiple links. The failure of one of these links will result in a failed SVCC. Such a failure may only represent a small change in the connectivity between the two LGNs. If a link internal to one of the two represented Peer Groups fails, it may represent no change in connectivity at all. Therefore, maintaining the state of the RCC between the LGNs and maintaining the states of the links between the LGNs must be independent functions in order to ensure the stability of the hierarchy. While the two functions are coupled into the same hello message, they are decoupled temporally, that is, separate sets of timers pertain to the two functions. Failure of the RCC monitoring function will cause the SVCC to be re-established. No change of state due to this event will occur in the state machines associated with the logical links until their own timer has expired.

5.6.3.1 SVCC-Based RCC Hello Protocol

The protocol used to verify the communications link between two LGNs is very close to the protocol between lowest-level neighbors, and uses the same packet type. However, unlike lowest-level neighbor nodes, LGN neighbors will have a single PNNI routing control channel between them. This SVCC-based RCC is used for the exchange of all PNNI routing packets between the LGN neighbors, including PTSPs and other packets used to maintain database synchronization as well as Hellos. The Hello protocol used to monitor the status of the SVCC triggers the AddPort and DropPort events in the neighboring peer state machine that control database synchronization between the LGNs. This is similar to the relationship between the Hello protocol and the neighboring peer state machines run between lowest-level neighbors. The event AddPort in the neighboring peer state machine is triggered when the Hello state machine for the SVCC reaches the state 2-Way Inside. The event DropPort in the neighboring peer state machine is triggered when the Hello state machine for the SVCC falls out of the 2-Way Inside state.

Once the SVCC is declared up by the signalling protocol, a Hello protocol instance is initiated. This protocol is essentially the same as the protocol that runs between lowest-level neighbors, with a few modifications:

1. A port value of 0xFFFFFFFF is always used in the Port ID field in Hello messages. SVCCs between LGNs do not have port IDs assigned to them. If a Hello is received in which the Port ID does not take the value of 0xFFFFFFFF, the event HelloMismatchReceived is triggered.
2. SVCC-based RCCs are always inside one peer group. The events 1-WayOutsideReceived, 2-WayOutsideReceived, CommonHierarchyReceived, and HierarchyMismatchReceived cannot be triggered for SVCCs between LGNs. Instead, if a Hello is received in which the Peer Group ID is not the same as this node's peer group ID, the event HelloMismatchReceived is triggered.
3. The node ID in received Hellos must be equal to the value in the corresponding uplink PTSE. If it is not equal the event HelloMismatchReceived is triggered.

For the LGN that is the calling party for the SVCC-based RCC, that uplink PTSE is necessarily received before the SVCC is initiated. For the LGN that is the called party, there is a race condition between the arrival of the call setup from the neighbor and the uplink PTSE. If the called-party LGN receives a SETUP from a node which it has yet to recognize as a neighbor, the called-party LGN must accept the call, but ignore any hellos until an uplink PTSE is received indicating that node as a neighbor. The binding between the uplink PTSE and the SVCC-based RCC is the node ID in Hellos received over the SVCC-based RCC and the Upnode ID in the uplink PTSE.

4. An SVCIntegrityTimer is set in the ~~Down~~, Attempt and One-way states, and in some cases in the Down state (see Sections 5.6.3.1.2 and 5.6.3.1.3). If the timer expires, the SVCC-based RCC is declared down and the SVCC is released with cause #16 "normal call clearing". When the LGN that is the calling party releases the SVCC, it immediately attempts to re-establish the SVCC and follows the procedures in step A.6 of Section 5.5.6.3.¹
5. For the LGN that is the called party, a HelloMismatchReceived event is handled by returning to the ~~ATTEMPT Attempt~~ state. For the LGN that is the calling party, a HelloMismatchReceived event is handled by releasing the SVCC with cause #16 "normal call clearing" and ~~re-establishing it, as starting the RetryLGNSVCTimer with value RetryLGNSVCTimeout~~. When the RetryLGNSVCTimer expires, the procedures described in Section 5.5.6.3~~5.5.6 are followed~~¹. The situation should also be logged and trapped to network management.
6. Failure of the SVCC indicated from lower levels (ATM, PHY, Signalling) is treated as a LinkDown Event. Procedures to re-establish the SVCC are followed, as described in Section 5.5.6.

5.6.3.1.1 The SVCC-Based RCC Hello Data Structure

~~There is a single hello data structure for each SVCC-based RCC to a neighboring node.~~¹

Each instance of this data structure consists of the following items:

State

The operational status of a link. This is described in more detail in Section 5.6.2.1.2. Note that only the inside states will apply.

Remote Node ID

The Node ID of the neighbor node on the other end of the link.

Remote Port ID

The neighbor's port ID for this link. When the Remote Port ID has not been received, its value is zero.

HelloInterval

The amount of time, in seconds, between Hellos that the node sends out over this link in the absence of event-triggered Hellos.

Hello Timer

An interval timer that fires every HelloInterval seconds. Whenever the timer fires, the node transmits a Hello over this link.

InactivityFactor

The amount of time, in multiples of the HelloInterval declared by the neighbor in its Hellos, before the node will consider the link down, if the neighbor's Hellos cease to arrive.

Inactivity Timer

A single shot timer whose expiration indicates that no Hellos have been received from this neighbor recently. The initial value of the Inactivity Timer must be set to the Inactivity Factor times the Hello Interval from the most recent Hello packet received from the neighbor node.

SVCIntegrityTime

The amount of time in seconds this node will wait for an SVCC-based RCC to reach 2-Way Inside state before releasing it.

SVCIntegrityTimer

The timer used to determine when to consider the SVCC unusable and therefore release it.

HorizontalLinkInactivityTime

The amount of time in seconds a node will continue to advertise a horizontal link for which it has not received and processed the LGN horizontal link IG.

Horizontal Link Inactivity Timer

A single shot timer whose expiration indicates that no LGN horizontal links IGs have been received from this neighbor recently.

Version

The current version of the Hello protocol being used for communication with this neighbor. If no acceptable version number has been derived, this field will be zero.

5.6.3.1.2 SVCIntegrityTimer

An SVCC-based RCC between LGNs is established by the LGN with the higher node ID.

At the calling node, the SVCIntegrityTimer is set 1) when the SVCC ~~establishment is initiated~~ becomes active¹, and 2) whenever the state machine enters the Attempt state or the OneWay state and the timer is not already running. The timer is disabled in the TwoWay and Down states. Expiration of the timer causes a return to the Down state. Upon entering the Down state the SVCC is released and normal procedures for re-establishment are followed. The SVCIntegrityTimer is started with the value SVCCallingIntegrityTime.

At the called node, the SVCIntegrityTimer is set when a ~~setup-SETUP~~¹ message is received from a LGN neighbor or whenever the state machine enters the Attempt state or the OneWay state and the timer is not already running. The timer is disabled in the TwoWay state. Expiration of the timer causes a return to the Down state and the SVCC is released. The SVCIntegrityTimer is started with the value SVCCalledIntegrityTime.

5.6.3.1.3 Loss of Neighbor Relationship

If the neighbor relationship is broken, i.e. all PTSEs describing uplinks to the LGN neighbor have been deleted, then the following procedures are invoked. Note that if the neighbor relationship is truly broken, then the SVCC should get released by the lower layers. It is possible that uplinks can temporarily disappear due to a lower level peer group partition (which does not cause a partition at this level) or a new node is elected PGL.

In this event, ~~if the SVCC-based RCC Hello State machine is in the 2-Way/Inside state, the node returns to the attempt state. Note that this will cause the SVCIntegrityTimer to be started first sends out a Hello packet with an empty LGN Horizontal Link Extension information group (see Section 5.6.3.2). The node then returns the SVCC-based RCC Hello State machine to the Down state and starts the SVCIntegrityTimer, but does not clear the SVCC-based RCC. While in the Down state, the node must ignore received Hellos and refrain from transmitting any Hellos to the neighbor, until an uplink PTSE is received indicating the neighbor as the upnode.~~¹

5.6.3.2 LGN Horizontal Link Hello Protocol

The protocol for determining the state of horizontal links between Logical Group Nodes is also based upon the Hello protocol. The states of all horizontal links to an LGN neighbor are determined from the information in a single LGN Horizontal Link Extension information group included in the Hellos sent over the SVCC-based RCC. The LGN Horizontal Link Extension information group is present in all Hellos transmitted to the neighboring peer LGN. Each time a Hello is sent to the neighboring peer, the LGN Horizontal Link Extension information group shall contain an entry for each horizontal link to the neighboring peer node in any state other than Down. For each horizontal link the Aggregation Token, Local Port ID, and Remote Port ID are included. Each distinct aggregation token value represents a distinct horizontal link with its own independent state machine. The information group is present in all Hellos transmitted.

On receipt of Hellos received from the neighboring peer LGN, the LGN Horizontal Link Extension information group is only processed if the SVCC-based RCC Hello State Machine is in 2-Way Inside and the corresponding neighboring peer state machine is in Full state.

An LGN horizontal link is advertised in PTSEs originated by this node if and only if the LGN horizontal link hello state is 2-Way. This is done instead of tightly coupling the advertisement of horizontal links to the neighboring peer state machine as done for physical links and VPCs. This avoids unnecessarily disturbing the status of horizontal links due to temporary and recoverable SVCC failures.

When an uplink PTSE arrives including a new aggregation token value, a logical port ID is assigned and a state machine created in the Down state. The AddInducingLink event is triggered, and the state machine transitions to the Attempt state. As a result of this, subsequent instances of the LGN Horizontal Link Extension information group will contain an entry for this token, the assigned Local Port ID, and a value of zero for the Remote Port ID. The AddInducingLink event is also triggered when a new inducing uplink is seen for an existing Aggregation Token value.

When an uplink for a particular aggregation token value is removed from the uplink PTSE in which it appeared or when the uplink PTSE is deleted, either the DropInducingLink or the DropLastInducingLink event, as appropriate, is triggered. For the DropLastInducingLink event, the aggregation token value and associated port ids are removed from the information group, and the state machine remains in the down state (or is deleted) until a new PTSE with that aggregation token value arrives.

A received aggregation token value in an LGN Horizontal Link Extension IG for which no state machine exists is ignored.

The absence of an aggregation token in the received LGN Horizontal Link Extension information group forces the state machine associated with that aggregation token to the Attempt state. This requires that the information group must be checked for the presence of all expected Token values.

Upon the loss of an SVCC-based RCC, for reasons other than a release with cause number 53 “call cleared due to change in PGL”, the status of the associated horizontal links are controlled by their own state machines. That is, each horizontal link remains up until the Horizontal Link Inactivity Timer expires, or until the last uplink containing this aggregation token is removed (i.e., the event DropLastInducingLink occurs). The Horizontal Link Inactivity Timer for horizontal links is started with the value HorizontalLinkInactivityTime. Since all horizontal links are reported in every Hello packet, a single LGN Horizontal Link Inactivity Timer is used for all the links to one neighbor.

In the event that the SVCC has been released with cause number 53 “call cleared due to change in PGL”, the horizontal link FSM is triggered with the event BadNeighbor.

5.6.3.2.1 The LGN Horizontal Link Hello Data Structure

There is an LGN horizontal link hello data structure for each horizontal link to a neighboring node.

Each LGN horizontal link hello data structure consists of the following items:

Aggregation Token

The aggregation token associated with this LGN horizontal link.

State

The operational status of the horizontal link.

Port ID

A number assigned by the node that identifies which horizontal link is described by this horizontal link hello data structure.

Remote Node ID

The Node ID of the neighbor node on the other end of the horizontal link.

Remote Port ID

The neighbor’s port ID for this link. The Remote Port ID is learned when the LGN Horizontal Link Extension IG is received from the neighbor. When the Remote Port ID is not known, its value must be set to zero.

Inducing Uplinks List

The list of inducing uplinks for this horizontal link. Each uplink is identified by the Node ID of the border node in the child peer group, and the Port ID of the inducing uplink.

5.6.3.2.2 LGN Horizontal Link States

The states that the LGN Horizontal Link Hello FSM may attain are described in this section.

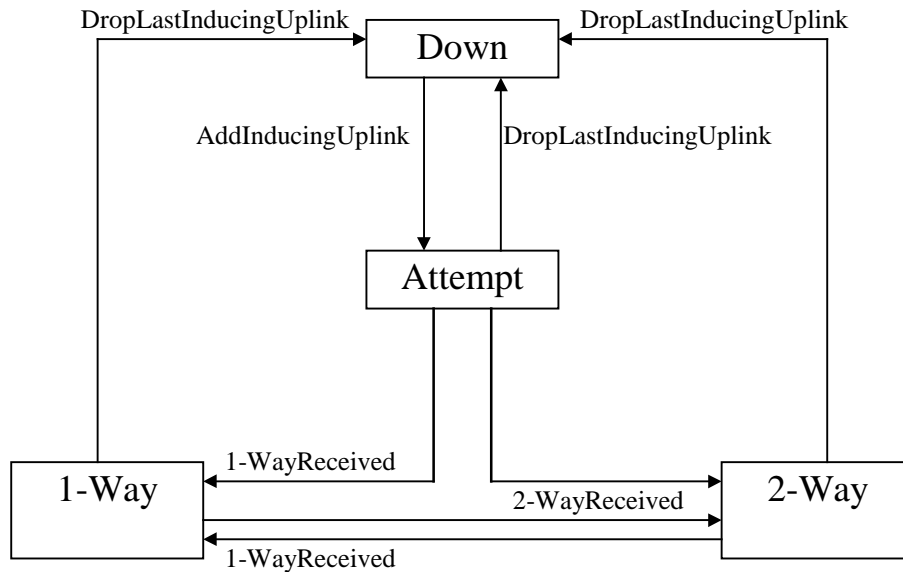

Figure 5-5: LGN Horizontal Link Hello FSM

Down

This state indicates that no uplink PTSEs have been received including an uplink to the neighboring peer LGN with the same aggregation token value as that indicated in the LGN horizontal link hello data structure.

Attempt

This state indicates that, although at least one uplink PTSE has been received including an uplink to the neighboring peer LGN with the same aggregation token value as that indicated in the LGN horizontal link hello data structure, no appropriate confirmation from the neighboring peer exists.

1-Way

In this state, Hellos have recently been received from the neighbor including an entry for this horizontal link in the LGN Horizontal Link Extension IG, but the remote port ID was set to zero.

2-Way

In this state, Hellos have recently been received from the neighbor including an entry for this horizontal link in the LGN Horizontal Link Extension IG containing the correct remote port ID. When this state is reached, it indicates that both neighboring peer LGNs know the port IDs on both sides of the horizontal link. In this state, the horizontal link is advertised in PTSEs.

5.6.3.2.3 LGN Horizontal Link Events

AddInducingLink

Either:

- (i) An uplink PTSE has arrived including a new inducing uplink to the neighboring peer node.
- (ii) Connectivity has been re-established to a border node advertising an inducing uplink(s). Note that such a connectivity recovery may affect several uplinks and in turn may affect aggregation of 1 several horizontal link FSMs, or
- (iii) A directly attached outside link to a descendant node of a neighboring peer LGN has reached the CommonOutside 2-WayOutside-1 state carrying the same aggregation token value as in the LGN horizontal link hello data structure.

In any of these three cases, attempt to locate the LGN horizontal link hello data structure that corresponds to the aggregation token for the given inducing link. If not found, then initialize one as follows: The State is set to Down. The Aggregation Token is set to the value associated with the inducing link. A unique Port ID value is selected and its value placed into the PortID field. The Remote Node ID is set to the peer's Node ID. The Remote Port ID is set to Null. The Inducing Links List is set to empty.

1-WayReceived

A Hello has been received including an entry for the Aggregation Token in the LGN Horizontal Link Extension IG in which the remote port ID is set to zero. Additionally, if the Remote Port ID field in the LGN horizontal link hello data structure is not equal to zero, it must match the port ID in the received Hello.

2-WayReceived

A Hello has been received including an entry for the Aggregation Token in the LGN Horizontal Link Extension IG in which the remote port ID correctly identifies the Port ID in the LGN horizontal link hello data structure. Additionally, if the Remote Port ID field in the LGN horizontal link hello data structure is not equal to zero, it must match the port ID in the received Hello.

HelloMismatchReceived

A Hello has been received for which either:

- (i) A HelloMismatch event is generated in the corresponding SVCC-based RCC Hello protocol, or
- (ii) the Aggregation Token in the LGN horizontal link hello data structure does not appear in the LGN Horizontal Link Extension IG, or
- (iii) the remote port ID in the entry for the Aggregation Token in the received LGN Horizontal Link Extension IG is different from the port ID in the LGN horizontal link hello data structure, and is not set to zero, or
- (iv) the remote port ID in the LGN horizontal link hello data structure is set and is different from the received port ID in the entry for the Aggregation Token in the LGN Horizontal Link Extension IG.

HorizontalLinkInactivityTimerExpired

The Horizontal Link Inactivity Timer has expired. This means that no Hellos have been received recently from the neighbor in which the LGN Horizontal Link Extension IG could be processed.

BadNeighbor

The corresponding SVCC-based RCC has been released with cause number 53 "call cleared due to change in PGL", ~~or a DSMismatch or BadPTSERequest has been generated in the corresponding neighboring peer FSM.~~³

DropInducingLink

Either

- (i) An inducing uplink for a particular Aggregation Token value has been removed from the uplink PTSE in which it appeared, and it was not the last inducing uplink for that particular Aggregation Token value, or
- (ii) the uplink PTSE containing an inducing uplink for a particular aggregation token value has been deleted (i.e., has timed out or has been flushed), and there still remains at least one inducing uplink for that particular Aggregation Token value, or
- (iii) connectivity to the border node in the child peer group that is advertising the inducing uplink(s) has been lost, and it was not the last inducing uplink for that particular Aggregation Token value. Note that such a connectivity loss may affect several uplinks and in turn may affect [aggregation of 1](#) several horizontal link FSMs, or
- (iv) A directly attached outside link to a descendant node of a neighboring peer LGN carrying the same aggregation token value as in the LGN horizontal link hello data structure has fallen out of the [CommonOutside 2-WayOutside 1](#) state, and it was not the last inducing outside link for that particular Aggregation Token value.

DropLastInducingLink

Either

- (i) the last inducing uplink for a particular Aggregation Token value has been removed from the uplink PTSE in which it appeared, or
- (ii) the uplink PTSE containing the last inducing uplink for a particular aggregation token value has been deleted (i.e., has timed out or has been flushed), or
- (iii) connectivity to the border node in the child peer group that is advertising the last inducing uplink(s) has been lost. Note that such a connectivity loss may affect several uplinks and in turn may affect [aggregation of 1](#) several horizontal link FSMs, or
- (iv) the last directly attached outside link to a descendant node of a neighboring peer LGN carrying the same aggregation token value as in the LGN horizontal link hello data structure has fallen out of the [CommonOutside 2-WayOutside 1](#) state.

5.6.3.2.4 Description of The Horizontal Link Hello State Machine

The finite state machine is a two dimensional table with States across the top of the table and Events down the left side. Each pairing of event and state crosses at a "cell" in the table. The cell shows what state transition should occur and the action to take. For example, for the event and state pair of "AddInducingLink" and "Down" the cell reads "Hlhp1, Attempt". "Attempt" is the new state and "Hlhp1" is the Action to be taken. The actions definitions can be found following table.

Table 5-11: Horizontal Link Hello FSM

<i>Events</i>	<i>States</i>			
	Down	Attempt	1-Way	2-Way
AddInducing-Uplink	Hlhp10, Attempt	Hlhp11, Attempt	Hlhp11, 1Way	Hlhp12, 2Way
1-WayReceived	Hlhp0, Down	Hlhp1, 1Way	Hlhp0, 1Way	Hlhp6, 1Way
2-WayReceived	Hlhp0, Down	Hlhp2, 2Way	Hlhp3, 2Way	Hlhp0, 2Way
HelloMismatch Received	Hlhp0, Down	Hlhp0, Attempt	Hlhp4, Attempt	Hlhp5, Attempt
HorizontalLink-Inactivity-TimerExpired	Hlhp0, Down	Hlhp0, Attempt	Hlhp4, Attempt	Hlhp5, Attempt
BadNeighbor	Hlhp0, Down	Hlhp0, Attempt	Hlhp4, Attempt	Hlhp5, Attempt
DropInducing-Uplink	FSM_ERR	Hlhp13, Attempt	Hlhp13, 1Way	Hlhp14, 2Way
DropLast-InducingUplink	FSM_ERR	Hlhp13, Down	Hlhp16, Down	Hlhp15, Down

FSM_ERR ~~_____~~ ~~Represents an internal implementation error—Should not occur.~~¹

Hlhp0

Action: Do nothing.

Hlhp1

Action: Set the Remote Port ID in the LGN horizontal link hello data structure to the Port ID listed in the entry for the Aggregation Token in the received LGN Horizontal Link Extension IG.

Hlhp2

Action: Set the Remote Port ID in the LGN horizontal link hello data structure to the Port ID listed in the entry for the Aggregation Token in the received LGN Horizontal Link Extension IG. Trigger an advertisement of the horizontal link in a new instance of a horizontal link PTSE originated by this node, provided the corresponding Neighboring Peer State machine is in state Full.

Hlhp3

Action: Trigger an advertisement of the horizontal link in a new instance of a horizontal link PTSE originated by this node, provided the corresponding Neighboring Peer State machine is in state Full.

Hlhp4

Action: The remote Port ID in the LGN horizontal link hello data structure is cleared.

Hlhp5

Action: The remote port ID in the LGN horizontal link hello data structure is cleared. The horizontal link must be removed from the PTSE originated by this node in which it has been advertised.

Hlhp6

Action: The horizontal link must be removed from the PTSE originated by this node in which it has been advertised.

Hlhp10

Action: Add the inducing uplink (identified by the Node ID of the border node in the child peer group and the Port ID for the inducing uplink) to the Inducing Uplink List.

Hlhp11

Action: Add the inducing uplink (identified by the Node ID of the border node in the child peer group and the Port ID for the inducing uplink) to the Inducing Uplink List in the LGN horizontal link hello data structure.

Hlhp12

Action: Add the inducing uplink (identified by the Node ID of the border node in the child peer group and the Port ID for the inducing uplink) to the Inducing Uplink List in the LGN horizontal link hello data structure. If the addition of the inducing uplink causes a significant change in the topology state parameters for the aggregated horizontal link, originate a new instance of the horizontal link PTSE.

Hlhp13

Action: Delete the inducing uplink (identified by the Node ID of the border node in the child peer group and the Port ID for the inducing uplink) from the Inducing Uplink List in the LGN horizontal link hello data structure.

Hlhp14

Action: Delete the inducing uplink (identified by the Node ID of the border node in the child peer group and the Port ID for the inducing uplink) from the Inducing Uplink List in the LGN horizontal link hello data structure. If the deletion of the inducing uplink causes a significant change in the topology state parameters for the aggregated horizontal link, originate a new instance of the horizontal link PTSE.

Hlhp15

Action: The remote port ID in the LGN horizontal link hello data structure is cleared. Delete the inducing uplink (identified by the Node ID of the border node in the child peer group and the Port ID for the inducing uplink) from the Inducing Uplink List in the LGN horizontal link hello data structure. Originate a new instance of the horizontal link PTSE that does not include any entry for this horizontal link, or flush the PTSE if there is nothing else in the PTSE.

Hlhp16

Action: The remote port ID in the LGN horizontal link hello data structure is cleared. Delete the inducing uplink (identified by the Node ID of the border node in the child peer group and the Port ID for the inducing uplink) from the Inducing Uplink List in the LGN horizontal link hello data structure.

5.6.3.3 Overall Procedures

Hellos are transmitted periodically whenever the SVCC-based RCC Hello state is other than Down. A single Hello timer exists per SVCC-based RCC to govern when Hellos are sent. In addition, event-triggered Hellos are sent in the following cases (subject to the hold-down timer):

- Upon every state change in the SVCC-based RCC Hello State Machine except for 1-Way Inside to 2-Way Inside or for any change to the Down state,
- Upon every state change in every LGN Horizontal Link Hello State Machine associated with the neighboring peer LGN, except for 1-Way to 2-Way (note that changes into or out of the Down state of the LGN Horizontal link Hello FSM cause event-triggered Hellos to be generated).¹
- Upon a state change in the corresponding Neighboring Peer state machine to the Full state.³

Any event ~~which that~~³ requires a Hello to be sent resets ~~this the Hello~~¹ timer.

Additionally, there are two inactivity timers. The Inactivity timer associated with the SVCC operates exactly as in the normal ~~Hello hello~~ protocol. ~~The Horizontal Link Inactivity Timer is¹ started when the corresponding SVCC-based RCC Hello protocol is in the 2-WayInside state and the corresponding neighboring peer state machine reaches Full state. The Horizontal Link Inactivity Timer is reset each time an either started if it is not already active or otherwise restarted each time a non-empty LGN Horizontal Link Extension IG is processed, since this IG describes all horizontal links to this neighbor. Note that LGN Horizontal Link Extension IGs these¹ are only-processed only¹ when the SVCC-based RCC Hello protocol is in the 2-WayInside state and the corresponding neighboring peer state machine is in Full state. The Horizontal Link Inactivity Timer is stopped when the last LGN Horizontal Link Hello FSM corresponding to the neighboring peer LGN goes out of the 2-Way state^{1, 3}.~~

5.7 Database Synchronization

When a node first learns about the existence of a neighboring peer node (residing in the same peer group), it initiates a database exchange process in order to synchronize the topology databases of the neighboring peers. The database exchange process involves the exchange of a sequence of Database Summary packets, which contains the identifying information of all PTSEs in a node's topology database. Database Summary packets are exchanged using a lock-step mechanism, whereby one side sends a Database Summary packet and the other side responds (implicitly acknowledging the received packet) with its own Database Summary packet. At most one outstanding packet between the two neighboring peers is allowed at any one time.

When a node receives a Database Summary packet from a neighboring peer, it examines its topology database for the presence of each PTSE described in the packet. If the PTSE is not found in the topology database or if the neighboring peer has a more recent version of the PTSE, then the node must request the PTSE from this neighboring peer, or optionally from another neighboring peer whose database summary indicates that it has the most recent version of the PTSE.

For lowest-level neighboring peers, there may be multiple parallel physical links and/or VPCs between them. As described in Section 5.6, each physical link and/or VPC between the two neighboring peers will run a separate Hello state machine. However, for the purposes of database synchronization and flooding, only one conversation is held between the neighboring peers. This conversation is described by the neighboring peer state machine and the neighboring peer data structure, which includes the information required to maintain database synchronization and flooding to the neighboring peer. Whenever a link reaches the Hello state 2-WayInside, the event AddPort is triggered in the corresponding neighboring peer state machine. Similarly, when a link falls out of the Hello state 2-WayInside, the event DropPort is triggered in the corresponding neighboring peer state machine. The database exchange process commences when the event AddPort is first triggered, after the first link between the two neighboring peers comes up. When the DropPort event for the last link between the neighboring peers occurs, the neighboring peer state machine will internally generate the DropPortLast event causing all state information for the neighboring peer to be cleared.

When PTSPs, PTSE Acknowledgment packets, Database Summary packets, or PTSE Request packets are transmitted, any of the links between the neighboring peers that is in the Hello state 2-WayInside may be used. Successive packets may be sent on different links, without any harmful effects on the distribution and maintenance of PNNI routing information. Links between lowest-level neighboring peers may only be advertised in PTSEs when the neighboring peer state machine is in Full state. For the case of neighboring lowest-level peers connected by physical links and VPCs, changes into or out of the Full state will cause new instances of one or more of this node's PTSEs to be originated or flushed.

Between neighboring peer logical group nodes, only the SVCC-based RCC is used for the exchange of PNNI routing packets. Similarly to the case of lowest-level neighboring peers, the neighboring peer state machine is coupled to the Hello state machine of the RCC. Note the Hello states of the horizontal links between the LGNs do not affect the neighboring peer state. When the Hello state of the RCC reaches 2-WayInside, the event AddPort is triggered in the neighboring peer state machine and the database exchange process commences. When the Hello state of the RCC falls out of the state 2-WayInside, the event DropPort is triggered in the neighboring peer state machine, causing it to transition from Full state to NPDown state.

In the case where neighbors communicate via an SVCC-based RCC, the neighboring peer state machine does not directly affect origination of horizontal link PTSEs. Rather, it affects the origination of horizontal link PTSEs indirectly through the Horizontal Link Hello protocol (see Section 5.6.3.2). In addition, when first originating a PTSE for a given link, the associated LGN Hello machine must be in 2-WayInside and the peer data structure must be in Full state.

5.7.1 The Neighboring Peer Data Structure

Each node has a single neighboring peer data structure for each neighboring peer node regardless of the number of links between those nodes. Neighboring peer conversations in states other than NPDown are called adjacencies. The neighboring peer data structure contains all information pertinent to a forming or formed adjacency between two neighboring peers. Neighbor nodes belonging to different peer groups will not form an adjacency.

State

The state of the neighboring peer FSM. This is described in more detail in Section 5.7.2.

Remote Node ID

The node ID used to identify the neighboring peer node.

Port ID List

The Port ID List is only used in the case of lowest-level neighboring peers, which are connected by physical links and/or VPCs. The Port ID List is a list of those links to the neighboring peer that are in the state 2-WayInside. When PTSPs, PTSE acknowledgment packets, database summary packets, or PTSE request packets are transmitted or retransmitted to the neighboring peer, any of the links specified in this list may be used.

Master/Slave

When the two neighboring peers are exchanging databases, they form a master/slave relationship. This relationship is relevant only for initial topology database exchange. The master sends the first Database Summary packet and chooses the initial DS Sequence Number. Retransmissions of Database Summary packets are controlled by the master. The slave can only respond to the master's Database Summary packets. The master/slave relationship is determined in the Negotiating state.

DS Sequence Number

An unsigned 32-bit number identifying individual database summary packets. When the Negotiating state is first entered, the DS sequence number should be set to a value not previously seen by the neighboring peer but not too large to safely avoid sequence number wrapping. One possible scheme is to use the lower 24 bits of the machine's time of day counter. The DS sequence number is then incremented by the master with each new Database Summary packet sent. The slave's DS sequence number indicates the last packet received from the master.

Peer Retransmission List

The list of PTSEs that have been flooded but not acknowledged by the neighboring peer. These will be retransmitted periodically until they are acknowledged, or until the neighboring peer state machine is taken down.

Associated with each entry in this list is a PTSE Retransmission Timer. This is an interval timer that fires after PTSERetransmissionInterval seconds. The timer is stopped when an acknowledgment is received that corresponds to that PTSE.

PTSERetransmissionInterval

Each unacknowledged PTSE is retransmitted every PTSERetransmissionInterval seconds.

Peer Delayed Acks List

The list of PTSEs for which delayed acknowledgments will be sent to a neighboring peer. Every PeerDelayedAckInterval seconds acknowledgment packets are transmitted to the neighboring peer that contain the PTSE identifying information for all entries on the Peer Delayed Acks List, and the list is cleared.

PeerDelayedAckInterval

This is the time interval between consecutive checks of the Peer Delayed Acks List.

Peer Delayed Ack Timer

When this timer expires, any unacknowledged PTSEs in the Peer Delayed Acks List are bundled in an acknowledgment packet and sent to the neighboring peer.

PTSE request list

The list of PTSEs that need to be requested in order to synchronize the two neighboring peers' topology databases. This list is created as Database Summary packets are received. PTSE Request packets are used to request each PTSE on this list from this neighboring peer, or optionally from any other neighboring peer known to possess the missing PTSE. The list is depleted as appropriate PTSEs are received.

DSRxmtInterval

The amount of time, in seconds, a node waits before it sends the previous Database Summary packet again.

DS Rxmt Timer

An interval timer that fires after DSRxmtInterval seconds. The timer is stopped when the node receives a correct Database Summary packet.

RequestRxmtInterval

The amount of time, in seconds, before a node sends a new PTSE Request Packet requesting PTSEs of the last PTSE Request Packet that have not been received yet.

Request Rxmt Timer

An interval timer that fires after RequestRxmtInterval seconds. The timer is stopped when all of the PTSEs requested in the last PTSE Request Packet have been received.

Last Received Database Summary Packet's Identifying Information

The Database Summary packet flags (including the Initialize, More, Master, and reserved bits) and DS sequence number contained in the last Database Summary packet received from the neighboring peer. This information is used to determine whether the next Database Summary packet received from the neighboring peer is a duplicate.¹

5.7.2 Neighboring Peer States

The neighboring peer state machine describes the state of database synchronization and flooding ongoing with the neighboring peer. Figure 5-6 shows a diagram of the possible state changes. The arcs of the graph are labeled with the events that cause each state change. The events are described in Section 5.7.3. For a detailed description of the neighboring peer state changes and the actions involved with each state change, see Section 5.7.4.

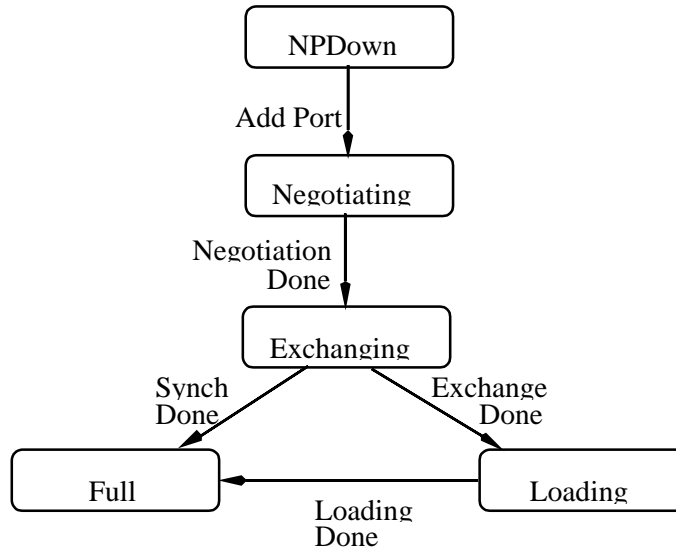

In addition to the state transitions pictured,

- Event DSMismatch forces Negotiating state,
- Event BadPTSERequest forces Negotiating state,
- Event DropPort causes no state change,
- Event DropPortLast forces NPDnwn state.

Figure 5-6: Neighboring Peer State Changes (Database Synchronization)

NPDnwn

The initial state of a neighboring peer FSM. This state indicates that there are no active links (i.e., in Hello state 2-WayInside) to the neighboring peer. In this state, there are no adjacencies associated with the neighboring peer.

Negotiating

The first step in creating an adjacency between the two neighboring peers. The goal of this step is to decide which node is the master, and to decide upon the initial DS sequence number.

Exchanging

In this state the node describes its topology database by sending Database Summary packets to the neighboring peer. Following as a result of processing Database Summary packets, required PTSEs can be requested.

Loading

In this state, a full sequence of Database Summary packets has been exchanged with the neighboring peer, and the required PTSEs are requested and at least one has not yet been received.

Full

In this state, this node has received all PTSEs known to be available from the neighboring peer. Links to the neighboring peer can now be advertised in PTSEs.

5.7.3 Events causing neighboring peer state changes

State changes can be brought about by a number of events. These events are triggered by procedures associated with database synchronization between the two neighboring peers, or by actions of the Hello state machines for the associated links. The events are shown in the labels of the arcs in Figure 5-6. A detailed explanation of the state changes and actions taken after an event occurs is given in Section 5.7.4. The events are defined as follows:

AddPort

A Hello state machine for a link to the neighboring peer has reached 2-WayInside state.

NegotiationDone

The Master/Slave relationship has been negotiated, and the initial DS sequence number has been agreed upon. For more information on the generation of this event, consult Section 5.7.6.

ExchangeDone

The neighboring peer's last Database Summary packet has been received, this node's last Database Summary packet has been sent, and the PTSE request list is not empty. The node now knows which PTSEs need to be requested. For more information on the generation of this event, consult Section 5.7.6.

SynchDone

The neighboring peer's last Database Summary packet has been received, this node's last Database Summary packet has been sent, and the PTSE request list is empty.

LoadingDone

The last PTSE on the PTSE Request List has been received.

DSMismatch

A Database Summary packet has been received that:

- a) has an unexpected DS sequence number, or
- b) unexpectedly has the Initialize bit set, or
- c) has an unexpected setting of the Master bit.

Any of these conditions indicates that an error has occurred in database synchronization.

BadPTSERequest

A PTSE Request has been received for a PTSE not contained in the database, or a received PTSE is less recent than the instance on the PTSE Request List. This indicates an error in database synchronization.

DropPort

A Hello state machine for a link to the neighboring peer has exited the 2-WayInside state.

DropPortLast

In processing a DropPort event, it was determined that all ports to this neighbor have been dropped.

5.7.4 The Neighboring Peer State Machine

The finite state machine is a two dimensional table with States across the top of the table and the Events down the left side. Each pairing of event and state cross at a “cell” in the table. The cell shows what state transition should occur and the action to take. For example, for the event and state pair of “AddPort” and “NPDown” the cell reads “Ds1, Negotiating”. “Negotiating” is the new state and “Ds1” is the Action to be taken. The actions can be found following table.

Table 5-12: Neighboring Peer FSM

<i>Events</i>	<i>States</i>				
	NPDown	Negotiating	Exchanging	Loading	Full
Add Port	Ds1 Negotiating	Ds7 Negotiating	Ds7 Exchanging	Ds7 Loading	Ds8 Full
Negotiation Done	FSM_ERR	Ds2 Exchanging	FSM_ERR	FSM_ERR	FSM_ERR
ExchangeDone	FSM_ERR	FSM_ERR	Ds3 Loading	FSM_ERR	FSM_ERR
SynchDone	FSM_ERR	FSM_ERR	Ds4 Full	FSM_ERR	FSM_ERR
Loading Done	FSM_ERR	FSM_ERR	FSM_ERR	Ds4 Full	FSM_ERR
DS Mismatch	FSM_ERR	FSM_ERR	Ds5 Negotiating	Ds5 Negotiating	Ds6 Negotiating
BadPTSE Request	FSM_ERR	FSM_ERR	Ds5 Negotiating	Ds5 Negotiating	Ds6 Negotiating
DropPort	FSM_ERR	Ds9 Negotiating	Ds9 Exchanging	Ds9 Loading	Ds9 Full
DropPort Last	FSM_ERR	Ds10 NPDown	Ds10 NPDown	Ds10 NPDown	Ds10 NPDown
<u>DS Rxmt Timer Expired</u>³	<u>FSM_ERR</u>	<u>Ds11</u> <u>Negotiating</u>	<u>Ds11</u> <u>Exchanging</u>	<u>FSM_ERR</u>	<u>FSM_ERR</u>
<u>Request Rxmt Timer Expired</u>³	<u>FSM_ERR</u>	<u>FSM_ERR</u>	<u>Ds12</u> <u>Exchanging</u>	<u>Ds12</u> <u>Loading</u>	<u>FSM_ERR</u>
<u>PTSE Rxmt Timer Expired</u>³ (1)	<u>FSM_ERR</u>	<u>FSM_ERR</u>	<u>Ds13</u> <u>Exchanging</u>	<u>Ds13</u> <u>Loading</u>	<u>Ds13</u> <u>Full</u>
<u>Peer Delayed Ack Timer Expired</u>³	<u>FSM_ERR</u>	<u>FSM_ERR</u>	<u>Ds14</u> <u>Exchanging</u>	<u>Ds14</u> <u>Loading</u>	<u>Ds14</u> <u>Full</u>

Note 1: A PTSE Retransmission timer is associated with each entry in the Peer Retransmission List. So there can be many PTSE Retransmission timers. The event PTSE Rxmt Timer Expired is related to one of these timers.³

FSM_ERR: Represents an internal implementation error.¹

~~—Action: Protocol error, should not occur.~~

Ds0

Action: Do nothing

Ds1

Action: For the case of lowest-level nodes, which are connected by physical links and/or VPCs, the port ID is added to the Port ID List in the neighboring peer data structure.

~~Upon entering this state, if this is the first time that an adjacency has been attempted, the DS sequence number should be assigned some unique value (like the time of day clock). Otherwise, the node increments the DS sequence number saved from the previous time this adjacency was active for this neighboring peer, if that information is still available~~ Upon entering this state, the node increments the DS sequence number for this neighboring peer. ~~If this is the first time that an adjacency has been attempted, the DS sequence number should be assigned some unique value (like the time of day clock)¹.~~ It then declares itself master (sets the Master bit to one), and starts sending Database Summary packets, with the Initialize, More, and Master bits set. No PTSE Summaries are included in this packet. This Database Summary packet is retransmitted at intervals of DSRxmtInterval until the next state is entered (See Section 5.7.5).

Ds2

Action: The node must begin sending a summary of the contents of its topology database to the neighboring peer in Database Summary packets. The topology database consists of the PTSEs either originated or received by this node, at the level of this node's peer group or at a higher level. Each Database Summary packet has a DS sequence number, and is implicitly acknowledged. Only one Database Summary packet is allowed outstanding at any one time. For more detail on the sending and receiving of Database Summary packets, see Sections 5.7.5 and 5.7.6.

Ds3

Action: Stop the DS Rxmt Timer if not previously stopped. Start (or continue) sending PTSE Request packets to this neighboring peer and/or optionally to other neighboring peers (see Section 5.7.7). Each PTSE Request packet asks for some of the neighboring peer's more recent PTSEs (which were discovered but not yet received in the Exchanging state). These PTSEs are listed in the PTSE Request list in the neighboring peer data structure.

Ds4

Action: Stop the DS Rxmt Timer if not previously stopped. The databases are now synchronized. For the case of lowest-level neighbor nodes, all links to the neighbor must now be advertised in PTSEs.

Ds5

Action: The Peer Delayed Ack Timer, DS Rxmt Timer, and Request Rxmt Timer are stopped if not previously stopped. The Peer Retransmission List, Peer Delayed Acks List, PTSE Request List and all related timers are cleared. The exchange of database summaries must start over again. The node increments the DS sequence number for this neighboring peer, declares itself master (sets the Master bit to one), and starts sending Database Summary packets with the Initialize, More, and Master bits set. No PTSE summaries are included in this packet. The DS Rxmt Timer is started and the Database Summary packet is retransmitted each DSRxmtInterval time.

Ds6

Action: Same as Ds5, except if there are any PTSEs advertising links to that neighbor, those PTSEs must be modified to remove the links. Such PTSEs must be re-originated or if necessary, flushed.

Ds7

Action: For the case of lowest-level neighboring peers, which are connected by physical links and/or VPCs, the port ID is added to the Port ID list in the neighboring peer data structure.

Ds8

Action: Same as Ds7 with the additional requirement that this action will cause a link to the neighboring peer to be added, causing a new instance of a PTSE to be originated.

Ds9

Action: The link is removed from the Port ID list in the corresponding neighboring peer data structure. The action will cause a link to the neighboring peer to be removed. [In the Full state¹](#) if there is a PTSE advertising that link, a new instance of the affected PTSE must be originated. If this was the last active link to this neighbor, generate the DropPortLast event.

Ds10

Action: The Peer Delayed Ack Timer, DS Rxmt Timer, and Request Rxmt Timer are stopped, if not previously stopped. The Peer Retransmission List, Peer Delayed Acks List, PTSE Request List and all related timers are cleared.

Ds11

Action: Send the previous Database Summary packet to the neighbor and restart the DS Rxmt timer.

Ds12

Action: Send a PTSE Request packet containing one or more entries from the PTSE Request List to this neighboring peer, and/or optionally to any other neighboring peers (see Section 5.7.7) and restart the corresponding Request Rxmt timer.

Ds13

Action: Those PTSEs that were last transmitted more than PTSE Retransmission Interval seconds ago and not yet acknowledged are encapsulated in a PTSP and transmitted to the neighboring peer (see Section 5.8.3.4). All related PTSE Retransmission Timers are restarted.

Ds14

Action: Send a PTSE Acknowledgment packet containing all PTSE identifying information items from the Peer Delayed Acks List to the neighboring peer. Acknowledged PTSEs are deleted from the Peer Delayed Acks List.³

5.7.5 Sending Database Summary Packets

This section describes how Database Summary packets are sent to a neighboring peer.

Only one Database Summary packet is allowed outstanding at any one time.

The sending of Database Summary packets depends on the neighboring peer state.

In the Negotiating state, the node sends empty Database Summary packets, with the Initialize, More and Master bits set. When sending such Database Summary packets, the DS Rxmt Timer must be restarted. These packets are retransmitted every DSRxmtInterval seconds, when the DS Rxmt Timer fires.

In the Exchanging state, including when sending the Database Summary packet in response to the event NegotiationDone, the Database Summary packets contain summaries of the topology state information contained in the node's database. In the case of Logical Group Nodes, those portions of the topology database that were originated or received at the level of the Logical Group Node or at higher levels are included in the database summary (lower level PTSEs may belong to the switching system's topology database for one or more of its incarnations as a lower level node, but do not belong to the logical group node's topology database). [Any portions of the topology database that were originated at the level of the Logical Group Node and with an Originating Peer Group ID different from the Peer Group ID of the Logical Group Node shall not be included in the database summary.](#) The PTSP and PTSE header information of each ~~such~~ PTSE [that is to be included in the database summary³](#) is listed in one of the node's Database Summary packets. PTSEs for which new instances are received after the Exchanging state has been entered need not be included in any Database Summary packet, since they will be handled by the normal flooding procedures. It is recommended but not required that each PTSE be included at most once in the entire sequence of Database Summary packets sent to the neighboring peer.

In the Exchanging state, the determination of when to send a Database Summary packet depends on whether the node is master or slave. When a new Database Summary packet is to be sent, the packet's DS sequence number is set as described in Section 5.7.6 and a new set of PTSEs from the node's topology database is described. Each item is considered to have been received by the neighboring peer when the Database Summary packet in which it was included is acknowledged. Note that the More bit is set asymmetrically, with different rules used depending on whether the node is master or slave:

Master

Database Summary packets are sent when either (i) the slave acknowledges the previous Database Summary packet by echoing the DS sequence number, or (ii) DSRxmtInterval seconds elapse without an acknowledgment, in which case the previous Database Summary packet is retransmitted. The DS Rxmt Timer must be restarted whenever a Database Summary packet is transmitted. If the node has already sent its entire sequence of Database Summary packets, then the More bit must be set to zero. If this packet includes the last portions of the database summary to be sent to the slave, then the More bit may optionally be set to zero. ~~If the node has already sent its entire sequence of Database Summary packets, or if this packet includes the last portions of the database summary to be sent to the slave, then the More bit must be set to zero¹.~~

Slave

Database Summary packets are sent only in response to Database Summary packets received from the master. If the packet received from the master is new, a new Database Summary packet is sent; otherwise the previous Database Summary packet is retransmitted. If the node has already sent its entire sequence of Database Summary packets (i.e., the contents of this Database Summary packet are empty), then the More bit must be set to zero.

In states Loading and Full the slave must resend its last Database Summary packet in response to duplicate Database Summary packets received from the master. Note that in the Loading or Full state, the last packet that the slave had sent must have been empty, with the Initialize, More, and Master bits set to zero and with the same DS sequence number as in the current neighboring peer data structure.

5.7.6 Receiving Database Summary Packets

This section explains the detailed processing of a received Database Summary packet. The incoming Database Summary packet is associated with a neighboring peer by the interface over which it was received. Each Database Summary packet has a DS sequence number, and is implicitly acknowledged. The further processing of the Database Summary packet depends on the state of the neighboring peer data structure associated with the Remote Node ID.

If a Database Summary packet is accepted, the following packet fields are saved in the corresponding neighboring peer data structure as the "Last Received Database Summary Packet's Identifying Information": the Database Summary packet flags (including the Initialize, More, Master, and reserved bits), and the DS sequence number. If these fields are set identically in two consecutive Database Summary packets received from the neighboring peer, the second Database Summary packet is considered to be a "duplicate" in the processing described below.¹

If the neighboring peer state is NPDown the packet must be ignored.

Otherwise, if the state is:

Negotiating

If the received packet matches one of the following cases, then the neighboring peer state machine must be executed with the event NegotiationDone (causing the state to transition to Exchanging) and the packet must be accepted as next in sequence and processed further. Otherwise, the packet must be ignored.

- The Initialize, More and Master bits are one, the contents of the packet are empty, and the neighboring peer's Node ID is larger than this node's own node ID. In this case this node is now a Slave. Upon generating the event NegotiationDone, the slave must take the following actions:
 - Stop the DS Rxmt Timer,
 - Set the Master bit to zero (indicating slave), set the Initialize bit to zero, set the DS sequence number to that specified by the master, and send a Database Summary packet to the master including the first portion of this node's database summary (see Section 5.7.5).
- The Initialize and Master bits are zero, the packet's DS sequence number equals the node's own DS sequence number (indicating acknowledgment), and the neighboring peer's node ID is smaller than the node's own node ID. In this case this node is Master. Upon generating the event NegotiationDone, the master must take the following actions (the last two actions need not be taken in this order):
 - Stop the DS Rxmt Timer,
 - Process the contents of the received Database Summary packet (see the last paragraph describing actions to be taken under the Exchanging state below),
 - Increment the DS sequence number by one, set the Initialize bit to zero¹, send a Database Summary packet to the slave including the first portion of this node's database summary (see Section 5.7.5) and restart the DS Rxmt Timer.

Exchanging

Execute the following steps in order:

- If the node is master and the received Database Summary packet is a duplicate, stop processing the packet.
- If the node is slave and the received Database Summary packet is a duplicate, respond by retransmitting the last Database Summary packet sent to the master and stop processing the received Database Summary packet.¹
- If the state of the Master bit is inconsistent with the master/slave state of the connection, generate the event DSMismatch and stop processing the packet. ~~Otherwise:¹~~
- If the Initialize bit is set, generate the event DSMismatch and stop processing the packet.
- If the node is master and the packet's DS sequence number equals the node's own DS sequence number (this packet is the next in sequence), the packet must be accepted and processed as follows (the last two actions need not be taken in this order):
 - Stop the DS Rxmt Timer,
 - Process the contents of the received Database Summary packet (see below),
 - In the following order:
 - A) Increment the DS sequence number by one,
 - B) If the node has already sent its entire sequence of Database Summary packets (i.e., the previous Database Summary packet that the node sent had the More bit set to zero), and the received packet also has the More bit set to zero, generate the event ExchangeDone if the PTSE Request List is not empty, or the event SynchDone if the PTSE Request List is empty.
 - C) Otherwise, send a new Database Summary packet to the slave and restart the DS Rxmt Timer (see Section 5.7.5).

~~If the node is master and the packet's DS sequence number is one less than the node's DS sequence number, the packet is a duplicate. Duplicates must be discarded by the master.¹~~

- If the node is slave and the packet's DS sequence number is one more than the node's own DS sequence number (this packet is the next in sequence), the packet must be accepted and processed as follows (in no particular order):
 - Process the contents of the received Database Summary packet (see below),
 - In the following order:
 - D) Set the DS sequence number to the DS sequence number appearing in the received packet,
 - E) Send a Database Summary packet to the master (see Section 5.7.5),
 - F) If the received packet has the More bit set to zero, and the just transmitted Database Summary packet also had its More bit set to zero (i.e., the contents of the just transmitted Database Summary packet were empty), then generate the event ExchangeDone if the PTSE Request List is not empty, or the event SynchDone if the PTSE Request List is empty.

~~If the node is slave, and the packet's DS sequence number is equal to the node's DS sequence number, the packet is a duplicate. The slave must respond to duplicates by repeating the last Database Summary packet that it had sent.¹~~

- Else, generate the event DSMismatch and stop processing the packet.

Processing the contents of a received Database Summary packet:

When the node accepts a received Database Summary packet as the next in sequence, the contents of the most recently transmitted Database Summary packet are acknowledged as having been received and the contents of the received Database Summary packet are processed as follows.

For each PTSE listed, the node looks up the PTSE in its database to see whether it also has an instance of the PTSE. If it does not, or if the database copy is less recent (see Section 5.8.2.2.3), one of the following actions is taken:

- If the listed PTSE is one of this node's self-originated PTSEs, the node must either:
 - Re-originate a newer instance of the PTSE with a larger sequence number, if the node has a valid instance of the PTSE (see Section 5.8.3.7), or
 - Flush the PTSE from the routing domain after installing it in the topology database with the remaining lifetime set to ExpiredAge (see Section 5.8.3.8).
- Otherwise, if the listed PTSE has PTSE Remaining Lifetime ExpiredAge, the PTSP and PTSE header contents in the PTSE summary must be accepted as a new or updated PTSE with empty contents. Follow the procedures for receiving a PTSE in Section 5.8.3.3 to determine whether or not the PTSE must be flooded to other neighboring peers, after installing the PTSE in the topology database.
- Otherwise, the PTSE is put on the PTSE request list, so that it can be requested from a neighboring peer (immediately or at some later time) in PTSE Request packets.

Loading or Full

In either of these states, the node has sent and received an entire sequence of Database Summary packets. The only packets received should be duplicates. Any other Database Summary packets received must generate the event DSMismatch, causing the adjacency to revert to the Negotiating state and the two neighboring peers to resynchronize their databases.

The procedures followed when receiving a Database Summary packet in the Loading or Full states are the same as those followed in the Exchanging state, except that packets accepted as the next in sequence must generate the event DSMismatch instead, and further processing of such packets must be stopped. Note that receipt of packets with an inconsistent Master bit or with the Initialize bit set to one must also generate the event DSMismatch.

5.7.7 Sending PTSE Request Packets

In states Exchanging and Loading, the PTSE request list contains a list of those PTSEs that need to be obtained in order to synchronize this node's topology database with the neighboring peer's topology database. To request these PTSEs, the node sends a PTSE Request Packet containing one or more entries from the PTSE request list. PTSE request packets are only sent in states Exchanging and Loading. A node may send a PTSE Request Packet to this neighboring peer, and/or optionally to any other neighboring peers that are in states Exchanging or Loading, and whose database summaries indicate that they have the missing PTSEs.

There must be at most one PTSE Request packet outstanding at any one time for each neighboring peer. Note that a node can control the flow of replies by choosing appropriately the number of PTSEs included in each PTSE Request packet.

Whenever a PTSE Request packet is transmitted to a particular neighboring peer, the Request Rxmt Timer in the corresponding neighboring peer data structure must be restarted. When the neighboring peer responds to these requests with the proper PTSE(s), i.e., any subset of what was requested, the received PTSEs are removed from the PTSE request list. When all of the PTSEs included in the last PTSE Request packet have been received from any neighboring peer, that PTSE Request packet is no longer considered to be outstanding, and,¹ a new PTSE Request packet may be sent to the same neighboring peer. If not all requested PTSEs are received within RequestRxmtInterval, then a new PTSE Request packet including the missing PTSEs and/or any other PTSEs from the PTSE Request List in the corresponding neighboring peer data structure may be transmitted. The missing PTSEs may instead be requested from other neighboring peers that are in states Exchanging or Loading, and whose database summaries indicate that they have the missing PTSEs, if desired. This process continues until the PTSE request list becomes empty.

When the PTSE request list becomes empty, and the neighboring peer state is Loading (i.e., a complete sequence of Database Summary packets has been both sent to and received from the neighboring peer), the LoadingDone event is generated.

5.7.8 Receiving PTSE Request Packets

Received PTSE Request packets specify a list of PTSEs that the neighboring peer wishes to receive. PTSE Request packets must be accepted when the corresponding neighboring peer state is Exchanging, Loading, or Full. In all other states PTSE Request packets must be ignored.

For each PTSE specified in the PTSE Request packet, an instance must be looked up in the node's topology database. The requested PTSEs are then bundled into PTSPs (in a fashion of this node's choosing) and are transmitted to the neighboring peer in a timely fashion. These PTSEs must not be placed on the peer retransmission list in the corresponding neighboring peer data structure. If a PTSE cannot be found in the database, something has gone wrong with the Database Exchange process and the event BadPTSErequest must be generated.

If a PTSE Request packet is received while the previous PTSE Request packet from that neighboring peer is still being processed, the processing of the earlier PTSE Request packet may be terminated provided that at least one PTSE has been sent in response to the previous PTSE Request packet. If no PTSEs have yet been sent in response to the previous PTSE Request packet, then at least one of the requested PTSEs must be sent, after which the processing of the previous PTSE Request packet may be terminated. The newly received PTSE Request packet is then processed as usual.¹

5.8 Topology Description and Distribution

5.8.1 Topology Information

Topology information includes topology state parameters and nodal information.

Topology information is specified in such a way as to allow for future extensibility. Specifically, topology information is encoded in Type/Length/Value format. This extensibility may be used, for example, to add support for preferential resource selection and policy-related functions, and QoS and traffic contract negotiation to meet phase 2 signalling requirements.

5.8.1.1 Topology State Parameters

Topology state parameter is a generic term that refers to either a link state parameter or a nodal state parameter. Topology state parameters fall into two categories: topology metric and topology attribute. A topology metric is a topology state parameter that requires the values of the state parameters of all links and nodes along a given path to be combined to determine whether the path is acceptable and/or desirable for carrying a given connection. A topology attribute is a topology state parameter that is considered individually to determine whether a given link or node is acceptable and/or desirable for carrying a given connection.

Topology attributes can further be divided into performance/resource-related topology attributes and policy-related topology attributes. A performance/resource-related topology attribute is a topology attribute that provides a measure of the cell transfer performance or a resource constraint associated with a topology component. A policy-related topology attribute is a topology attribute that characterizes the level of conformance of a topology component to a specific policy constraint. For example, Available Cell Rate is a performance/resource-related topology attribute, whereas Restricted Transit is a policy-related topology attribute.

Table 5-13: Topology States Parameters

Topology State Parameters		
Topology Metrics	Topology Attributes	
	Performance/Resource Related	Policy Related
Cell Delay Variation (CDV)	Cell Loss Ratio for CLP=0 (CLR ₀)	Restricted Transit flag
Maximum Cell Transfer Delay (maxCTD)	Cell Loss Ratio for CLP=0+1 (CLR ₀₊₁)	
Administrative Weight (AW)	Maximum Cell Rate (maxCR)	
	Available Cell Rate (AvCR)	
	Cell Rate Margin (CRM)	
	Variance Factor (VF)	
	Restricted Branching Flag	

5.8.1.1.1 Link State Parameters

A link state parameter provides information that captures an aspect or property of a link. Since links in an ATM network are bi-directional, a link state parameter implicitly includes the direction of the link it describes. Under the PNNI hierarchical structure, a link attached to a node can either be a horizontal link or an uplink. A horizontal link is a link between two nodes in the same peer group. An Uplink represents a connectivity between a border node in a peer group and a higher level upnode that is outside of the peer group. For horizontal links, link state parameters for the outgoing direction of the link are advertised by this node as identified by the local node ID and local port ID. Link state parameters for the incoming direction of a horizontal link are advertised by the neighboring peer node as identified by the neighboring peer's node ID and port ID associated with the link. For uplinks, link state parameters for both directions of the link are advertised by this node as identified by the local node ID and local port ID.

5.8.1.1.2 Nodal State Parameters

A nodal state parameter provides information that captures an aspect or property of a node. Nodal state parameters are used to construct the PNNI complex node representation if the Nodal Representation flag in the Nodal Information is set to one. A nodal state parameter is direction specific, and the direction is identified by a pair of input and output port IDs of the logical node of interest. The nucleus or interior reference point in the complex node representation is assigned zero as its port ID. The default "radius" in the PNNI complex node representation is identified by its input and output port IDs being both zero, and is by definition symmetric. For each nodal state parameter, only the default "radius" is required in the complex node representation, and any non-default value associated with a pair of ports or a port and the nucleus is optional. The nucleus may be interpreted as the center of a peer group when the peer group is a destination peer group, or the "mid-point" between any pair of border nodes in a peer group when the peer group is a transit peer group.

5.8.1.1.3 Resource Availability Information Group (RAIG)

The Resource Availability Information Group contains information that is used to attach values of topology state parameters to nodes, links, and reachable addresses (see Section 5.14.5).

5.8.1.1.3.1 Resource Availability Information Group Flags

These flags affect the interpretation of the topology state parameters in the RAIG in PNNI protocol messages.

The upper 5 bits of the RAIG Flags indicate which service categories the topology state parameters contained in the RAIG apply to. There is 1 bit for each defined service category. This allows one set of topology state parameters to apply to one or more service categories. If the topology state parameters for different service categories are not the same, multiple RAIGs, each carrying a set of topology state parameters, are advertised; these RAIGs are all contained within a single information group describing the entity. For each service category there is at most one set of topology state parameters that is advertised. If there are no topology state parameters advertised for a service category, that service category is not supported by that entity.

The least significant bit of these flags defines the applicability of the CLP bit to the interpretation of the topology state parameters included in this RAIG. Specifically, when this bit is 0, Table 5-16 shall be used to map the PCR and SCR in signalling to the PCR and SCR used in GCAC. When the bit is 1, Table 5-17 is used.

5.8.1.1.3.2 Cell Delay Variation (CDV)

The peak-to-peak CDV is the $((1-\alpha)$ quantile of the CTD) minus the fixed CTD that could be experienced by any delivered cell on a connection during the entire connection holding time, specified in microseconds. For more details refer to the Traffic Management [4.1-4.0³](#) specification.

CDV is a required topology metric for CBR and Real Time VBR service categories. CDV is not applicable to Non-Real Time VBR, ABR and UBR service categories.

In this version of the specification, CDV accumulation is done according to the simple method specified in the Traffic Management [4.1-4.0³](#) specification, i.e., it is additive.

5.8.1.1.3.3 Maximum Cell Transfer Delay (maxCTD)

MaxCTD is the sum of the fixed delay component across the link or node and CDV.

MaxCTD is a required topology metric for CBR, real time VBR, and non-real time VBR service categories. MaxCTD is not applicable to UBR and ABR service categories. This is specified in microseconds, and is a metric combined by addition along the path.

In this version of the specification, maxCTD accumulation is done according to the simple method specified in the Traffic Management [4.1-4.0³](#) specification, i.e., it is additive.

5.8.1.1.3.4 Administrative Weight (AW)

The administrative weight is a value set by the network operator. It is used to indicate the relative desirability of using a link or node for whatever reason significant to the network operator. It should however not be misused to express information contained in other topology state parameters (like AvCR or maxCR) or combinations thereof.

Administrative weight is a required topology metric for all service categories. This is a dimensionless value whose default is DefaultAdminWeight. A higher value describes a link or node which is less desirable to be used than a link with a lower value. [The permitted range is 1 to 16,777,215. The upper limit was chosen to allow 32-bit arithmetic to be used in accumulating administrative weight for the path.¹](#)

The administrative weight of a path is defined as the sum of the administrative weights of the links and nodes contained in the path.

5.8.1.1.3.5 Cell Loss Ratio for CLP=0 (CLR₀)

CLR₀ is the maximum cell loss ratio (CLR) objective for CLP=0 traffic. CLR is defined as the ratio of the number of cells that do not make it across the link or node to the total number of cells transmitted across the link or node.

CLR₀ is a required topology attribute for CBR, real time VBR, and non-real time VBR service categories. CLR₀ is not applicable to the ABR and UBR service categories.

5.8.1.1.3.6 Cell Loss Ratio for CLP=0+1 (CLR₀₊₁)

CLR₀₊₁ is the maximum cell loss ratio (CLR) objective for CLP=0+1 traffic. CLR is defined as the ratio of the number of cells that do not make it across the link or node to the total number of cells transmitted across the link or node.

CLR₀₊₁ is a required topology attribute for CBR, real time VBR, and non-real time VBR service categories. CLR₀₊₁ is not applicable to the ABR and UBR service categories.

5.8.1.1.3.7 Maximum Cell Rate (maxCR)

MaxCR is the maximum capacity usable by connections belonging to the specified service category.

MaxCR is a required topology attribute for ABR and UBR service categories. MaxCR is an optional topology attribute for CBR, real time VBR and non-real time VBR service categories. MaxCR is expressed in units of cells per second.

MaxCR = 0 is a distinguished value used to indicate inability to accept new connections in UBR and ABR service categories.

5.8.1.1.3.8 Available Cell Rate (AvCR)

AvCR is a measure of effective available capacity for CBR, Real Time VBR and Non-Real Time VBR service categories. For ABR service category, AvCR is a measure of capacity available for minimum cell rate (MCR) reservation.

AvCR is a required topology attribute for CBR, real time VBR, non-real time VBR and ABR service categories. AvCR is not applicable to UBR service category. AvCR is expressed in units of cells per second.

5.8.1.1.3.9 Cell Rate Margin (CRM)

CRM is a measure of the difference between the effective bandwidth allocation and the allocation for sustainable cell rate in cells per second. The CRM is an indication of the safety margin allocated above the aggregate sustainable cell rate.

CRM is an optional topology attribute for real time VBR and non-real time VBR service categories. CRM is not applicable to CBR, ABR, and UBR service categories. CRM is expressed in units of cells per second.

5.8.1.1.3.10 Variance Factor (VF)

VF is a relative measure of the square of the cell rate margin normalized by the variance of the sum of the cell rates of all existing connections (see equations 1 and 2 in Appendix B).

VF is an optional topology attribute for real time VBR and non-real time VBR service categories. VF is not applicable to CBR, ABR, and UBR service categories. VF is a dimensionless ratio.

5.8.1.2 Nodal Information

Nodal Information describes the node (not including resource availability information, and not including reachability information). It specifically includes the following:

- ATM End System Address of the node
- leadership priority
- nodal information flags
- preferred peer group leader node ID
- next higher-level binding information (included if this node is Peer Group Leader)

5.8.1.2.1 ATM End System Address of the Node

This field provides the ATM address that may be used to reach the node. Note that this is distinct from the node's Node ID.

5.8.1.2.2 Leadership Priority

This field indicates the desirability of this node to operate as Peer Group Leader. This is used in the PGL election.

5.8.1.2.3 Nodal Information Flags

Currently five flags are defined: the "I am leader" flag, the Restricted Transit flag, the Nodal Representation flag, the Restricted Branching flag, and the Non-transit for PGL Election flag. The rest of this field is reserved for use in future versions of PNNI.

The "I am leader" flag is set to one by a node in a peer group to declare that it is the PGL for the peer group. This is used in the PGL election.

In some cases a PNNI node is not permitted to be used for transit purposes except by certain restricted sets of traffic. The Restricted Transit flag is provided in the nodal state parameters to indicate whether the node is restricted. If it is restricted, then the node may not be used for transit purposes unless there is information present elsewhere in the node state parameters that explicitly explains or overrides the restriction. The Restricted Transit flag is a policy-related topology attribute.

If a node has the Restricted Transit set to one, then that node may nonetheless be used as the first or last node of a DTL (i.e., the node may originate calls, and it may be used without any restriction to reach an address that is advertised as directly reachable via an Internal ATM Address reachable via that node). For logical group nodes, any lower level peer group that is summarized into the LGN is considered part of that LGN, and thus may be reached via that node even if the node is Restricted Transit.

The Restricted Transit flag may be used on its own to indicate that a node is non-transit. It also may be used in combination with additional information to indicate that a node may be used for transit only in restricted circumstances. For example, suppose that in the future a new PNNI information group is defined, and that that new information group can be used to determine whether the node can be used for transit. In this case the node would be marked Restricted Transit. An information group would also be included that is marked "non-mandatory" (meaning that a node that does not understand the new information group can safely ignore it). In this case, an old node (the nodes that do not understand the newly defined information group) would use the node only to reach systems directly reachable via that node. A new node would interpret the information group, and would be able to use the values of the new information group to determine whether to override the Restricted Transit flag.

The Nodal Representation bit is used by a node to declare whether it is represented using the simple node representation or the complex node representation. If it is set to one-zero¹ to indicate the simple node representation, then no nodal state parameters PTSEs from this node will be considered in route computation; rather, the node will be represented as a single point, and all relevant topology state parameters will be given only with the corresponding horizontal links, uplinks, exterior reachable addresses and transit networks attached to the node.

The Restricted Branching flag is used to indicate if this node can branch point-to-multipoint traffic. When this bit is set to zero, then the node can support additional branching points for point-to-multipoint calls. If set to one, the node cannot currently support additional branching points for point-to-multipoint calls. The Restricted Branching flag is a resource-related topology attribute.

The Non-transit for PGL Election flag is set by a node when it is necessary for that node to be ignored when computing connectivity in the PGL election algorithm. This flag must be set to zero in a normally operating node. It must be set to one when the node is operating in a topology database overload state (i.e., it is currently unable to store and propagate the entire set of active PTSEs).

5.8.1.2.4 Preferred Peer Group Leader Node ID

This field specifies the node ID of the node that this node considers to be its choice for PGL. This is used in the PGL election.

5.8.1.2.5 Next Higher Level Binding Information

This field consists of an information group that is sent by PGLs in order to inform all nodes in the peer group of the higher level binding information to the parent LGN representing this peer group in the parent peer group. This is used for calculation of routes across multiple levels of the hierarchy; it is also used by border nodes during the bootstrapping of the hierarchy.

5.8.1.2.5.1 Parent Logical Group Node ID

This field contains the node ID of the parent LGN.

5.8.1.2.5.2 Parent Logical Group Node's ATM End System Address

This field contains the ATM End System Address of the parent LGN.

5.8.1.2.5.3 Parent Peer Group ID

This field contains the peer group ID of the peer group in which the parent LGN is instantiated.

5.8.1.2.5.4 Node ID of PGL of Parent Peer Group

This field contains the node ID of the node elected as peer group leader of the parent peer group. If the parent LGN is not aware of a peer group leader having been elected in the parent peer group, then this field is set to zero. The parent LGN determines that it should advertise the node ID of the PGL of the parent peer group when the preferred PGL of the parent LGN advertises in that node's information group that it is PGL by setting the "I am leader" bit.

5.8.1.3 Reachability Information

Reachability Information is topology information that binds reachable addresses to nodes within the PNNI hierarchy.

Internal and exterior reachability information is logically distinguished based on its source. Exterior reachability is derived from other protocol exchanges outside this PNNI routing domain. Internal reachability represents local knowledge of reachability within the PNNI routing domain. The primary significance of this distinction is that exterior reachability information shall not be advertised to other routing protocols or routing domains (for fear of causing routing loops across routing domains). Manual configuration can be used to create internal or exterior reachability information with corresponding effects on what is advertised to other routing protocols or domains.

5.8.1.3.1 Internal Reachable Addresses

This information group describes internally reachable ATM destinations. At the lowest level, this generally represents a summary of systems which have registered with ILMI or have been manually configured. At higher levels of the hierarchy, it summarizes information provided by members of the peer group.

While internal reachable summaries are derived from configuration, they are driven by the existence of destinations which fall within those summaries. Guidelines for the proper use of configured summaries are given in Section 5.9. The reader may also wish to refer to the example in Section 3.5.

The information in an internal reachable ATM address information group is

- Port ID — A port ID of value zero indicates that the internal reachable ATM addresses are attached directly to the nucleus in the PNNI default node representation for routing purposes. If the port is specified (i.e., is non-zero), then it may optionally be used in DTLs. Also, when a complex node representation is used, inclusion of port IDs with internal reachable addresses allows for more accurate definition of the nodal state parameters associated with the node announcing the address. Any non-zero port used for an internal reachable address advertisement must not be advertised in any horizontal links or uplinks information groups in any of this node's PTSEs.
- Scope of advertisement — This is the highest level of the hierarchy to which the associated reachability is advertised.
- Address Information Length — The number of octets for each reachability summary, including the prefix length field.
- Address Information Count — The number of address prefixes in the information group.
- Pairs of prefix length and prefix — The prefix length is the number of significant bits in the prefix. The prefix itself is the summary of reachable ATM addresses. The prefix is padded with zero bits on the right (see padding algorithm specified in Section 5.14.9.1). (The Address Information Length includes the prefix length field.)
- Optional information groups for resource availability information for both the outgoing and incoming directions.
- [Unknown information groups tagged as summarizable and transitive \(see Section 5.14.2.3\).](#)³

Note that there is no requirement that all prefixes in a given Internal Reachable Address Information Group have the same prefix length (though they are all encoded with the same address information length). The only requirement is the practical one that each must fit, with the individual prefix length fields, within the number of octets specified by the address information length.

Some information groups, such as Resource Availability information groups and transitive unknown information groups, may optionally be associated with internal reachable addresses, and if present applies equally to all the reachable addresses in the information group. Any optional information group included in an internal reachable address information group applies equally to all the contained reachable addresses. This implies that a set of internal prefixes may be grouped into a single information group only if every optional information group included in the reachable address information group can be applied to all the prefixes in the set.³

If ~~not specified~~ no Resource Availability information group is included³, then it is assumed that reaching the node (or node and port) which is advertising the internal address is sufficient to reach the specified destination. Resource Availability information may be specified for both the incoming and outgoing direction. If Resource Availability information is specified, then it must be specified for all service categories supported on the link in both directions, using the same set of types as is used internal to the PNNI routing domain.

5.8.1.3.2 Exterior Reachable ATM Addresses

The exterior reachability advertisement includes information about accessibility of both exterior addresses and transit networks.

Like the Internal reachable address summary, this describes reachability to a set of ATM destinations. The implication of using an exterior advertisement is that the information about the reachability came from elsewhere. This can include cases such as other complete PNNI instances, or configuration about what is reachable over a specific link.

In an exterior reachability advertisement that has transit network information, the external reachability information and RAIG(s) provided are related to the specified transit networks. Given multiple such advertisements for the same transit network, the related information may be used to select among entrances to that transit network.

The information in an exterior reachable ATM address information group is:

- Port ID — A port ID of value zero indicates that the exterior reachable ATM addresses are attached directly to the nucleus in the PNNI default node representation for routing purposes. If the port is specified (i.e., is non-zero), then it may optionally be used in DTLs. Also, when a complex node representation is used, inclusion of port IDs with exterior reachable addresses allows for more accurate definition of the nodal state parameters associated with the node announcing the address. Any non-zero port used for an exterior reachable address advertisement must not be advertised in any horizontal links or uplinks information groups in any of this node's PTSEs.
- Scope of advertisement — This is the highest level of the hierarchy to which the associated reachability is advertised.
- Address Information Length — The number of octets for each reachability summary, including the prefix length field.
- Address Information Count — The number of address prefixes in the information group.
- Pairs of prefix length and prefix — The prefix length is the number of significant bits in the prefix. The prefix itself is the summary of reachable ATM addresses. The prefix is padded with zero bits on the right (see padding algorithm specified in Section 5.14.9.1). (The Address Information Length includes the prefix length field.)
- Optional information groups for resource availability information for both the outgoing and incoming directions.
- Optional Transit Network ID information groups.
- [Unknown information groups tagged as summarizable and transitive \(see Section 5.14.2.3\).](#)³

Note that there is no requirement that all prefixes in a given Exterior Reachable Address Information Group have the same prefix length (though they are all encoded with the same address information length). The only requirement is the practical one that each must fit, with the individual prefix length fields, within the number of octets specified by the address information length.

~~Some information groups, such as Resource Availability information groups and transitive unknown information groups, may optionally be associated with exterior reachable addresses, and if present applies equally to all the reachable addresses and transit networks in the information group. Any optional information group included in an exterior reachable address information group applies equally to all the contained reachable addresses and transit networks. This implies that a set of exterior prefixes may be grouped into a single information group only if every optional information group included in the reachable address information group can be applied to all the prefixes in the set.~~³

~~If not specified no Resource Availability information group is included~~³, then it is assumed that reaching the node (or node and port) which is advertising the exterior address is sufficient to reach the specified destination. Resource Availability information may be specified for both the incoming and outgoing direction. If Resource Availability information is specified, then it must be specified for all service categories supported on the link in both directions, using the same set of types as is used internal to the PNNI routing domain.

5.8.2 PTSPs and PTSEs

Topology information is reliably distributed to all nodes in a peer group. This information describes the topology of the peer group, including all nodes and links in the peer group, and also the destinations that each node can reach.

For the detailed format and encodings of PTSPs and PTSEs refer to Section 5.14.

5.8.2.1 PTSPs

The PTSP is the packet used to send PNNI topology information to a neighboring peer. The PTSP contains one or more PTSEs describing individual aspects of the topology. Each PTSP carries information from a single originator for a single scope. These are carried in the following two fields of the PTSP header:

- **Originating Node ID**
The node identifier of the node that originated all the PTSEs contained in this PTSP.
- **Originating Node's Peer Group ID**
The peer group identifier of the node that originated all the PTSEs contained in this PTSP. This defines the span over which the PTSEs contained in this PTSP will be flooded. Note that this span logically includes all child peer groups of the identified peer group.

Note that the grouping of PTSEs within PTSPs may vary. A sender is not required to forward PTSEs to a neighboring peer grouped into PTSPs in the same manner as they were received. Similarly, a sender is not required to group PTSEs into PTSPs the same way as any particular previous transmission.

5.8.2.2 PTSEs

PTSEs are the units of flooding and retransmission. A node originates one or more PTSEs to describe its current operating characteristics (i.e., active links, their available bandwidth, etc.). PTSEs are distributed throughout a PNNI peer group via flooding.

5.8.2.2.1 PTSE Header Contents

Each PTSE header contains the following items:

- **PTSE Identifier**
When a node originates multiple PTSEs, each describing different pieces of the node's environment (e.g., each may describe a different set of links), the PTSEs are distinguished by PTSE Identifier. This is an unsigned 32-bit number, whose assignment is solely up to the originating node.
- **PTSE Sequence Number**
When multiple instances of the same PTSE exist simultaneously, the PTSE Sequence Number determines which instance is "more recent". PTSE Sequence Number is a 32-bit unsigned number.
- **PTSE Checksum**
PTSE Checksum serves the following purposes:
 - it indicates whether a PTSE has been corrupted, either during flooding or while being held in the node's topology state database and
 - in certain exception cases, it is used to decide which of two PTSE instances is treated as more recent.
- **PTSE Remaining Lifetime**
The number of seconds before the PTSE will be considered invalid. PTSE Remaining Lifetime is decremented:
 - while the PTSE is held in a node's topology database and
 - during flooding.

If the PTSE Remaining Lifetime hits ExpiredAge, it is reflooded and removed from the peer group's topology database. The initial value for this field is PTSERefreshInterval multiplied by the PTSELifetimeFactor.

- PTSE Type
The PTSE Type field indicates which restricted information groups are allowed to appear inside of the PTSE, or that no restricted information groups are allowed¹ (see Section 5.14.9 for details).

5.8.2.2.2 PTSE Checksum algorithm

The checksum field is the 16 bit one's complement of the one's complement sum of all 16 bit words in the PTSE except the Lifetime. In addition, the Originating Node ID and Originating Node's Peer Group ID fields from the PTSP header are included. For purposes of computing the checksum, the value of the checksum field is zero.

5.8.2.2.3 PTSE identification and PTSE instance identification

To implement the flooding procedures, each PTSE, and each instance of a given PTSE, must be uniquely identified. The information used for identifying a PTSE is:

- Originating Node ID
- PTSE identifier

The additional information that distinguishes one instance of a PTSE from another instance of the same PTSE is:

- PTSE sequence number
- PTSE remaining lifetime
- PTSE checksum

Most of this identifying data is carried in the PTSE header, except for the Originating Node ID, which is carried in the header of the PTSP that contains the PTSE.

5.8.2.2.4 Comparison of PTSE instances

Two PTSEs having the same Originating Node ID and PTSE Identifier but different PTSE Sequence Numbers are different instances of the same PTSE. For example, one PTSE may be an update for the other.

When two instances of the same PTSE exist simultaneously, they must be compared to see whether they are separate instances and, if so, which instance is "more recent". A more recent PTSE always takes precedence over less recent PTSEs. This comparison consists of the following steps:

- 1) The PTSE instance having the larger PTSE Sequence Number, when compared as 32-bit unsigned integers, is considered more recent.
Otherwise (i.e. both copies have the same PTSE Sequence Number),
- 2) If one PTSE copy has PTSE Remaining Lifetime equal to ExpiredAge, and the other does not, the copy having PTSE Remaining Lifetime of ExpiredAge is considered more recent.
Otherwise (i.e., either both copies are expired or both are not expired),
- 3) If both copies have PTSE Remaining Lifetime other than ExpiredAge and the PTSE Checksums are different, ~~The-the~~ PTSE copy having the larger PTSE Checksum when compared as unsigned numbers is considered to be more recent. (Note: When the two copies have different PTSE Checksums, they have different contents, and so are different instances. It is however impossible at this point to determine which one is really "more recent". If the chosen PTSE copy is not really most recent, the PTSE's originator will end up re-originating the PTSE.).
~~Otherwise, both copies have the same PTSE Checksum, and Both copies are assumed to be the same PTSE instance.~~³
- 4) Otherwise (i.e. either both copies are expired, or both are not expired and their checksums are equal), they are assumed to be the same PTSE instance.³

5.8.3 Flooding

5.8.3.1 Overview

The PNNI flooding algorithm provides for reliable distribution of PTSEs throughout a peer group. It ensures that each node in the peer group has a synchronized topology database (i.e., collection of PTSEs).

All adjacencies in Exchanging, Loading, or Full states are used by the flooding procedures, and must be fully capable of transmitting and receiving all types of PNNI routing packets.

In essence, the flooding procedure is as follows. PTSEs are encapsulated within PTSPs. When a PTSP is received its component PTSEs are examined. Each PTSE is acknowledged by encapsulating its PTSE identifying information within an "Acknowledgment Packet", which is then sent back to the neighboring peer. If in addition the PTSE is more recent than the node's current copy, the PTSE is installed in the topology database and flooded to all other neighboring peers. The fact that the PTSEs were sent to these neighboring peers is remembered, and they will be retransmitted until acknowledged.

The flooding procedure is described in detail in the following sections.

5.8.3.2 Sending PTSPs

PNNI nodes exchange link state information in PNNI Topology State Packets (PTSPs). The format of PTSPs is given in Section 5.14.

Nodes build and send PTSPs in response to these events:

- (self) origination of a new PTSE (see Section 5.8.3.7)
- re-origination of a new instance of a (self originated) PTSE (see Section 5.8.3.7)
- installation into the database of new instances of non-self-originated PTSEs received which must be flooded onward to other peers (see Sections 5.7.6 and 5.8.3.3)
- expiration of the PTSE retransmission timer when there are unacknowledged PTSEs on a Peer Retransmission List (see Section 5.8.3.4)
- in response to a PTSE request (see Section 5.7.8)
- expiration of the PTSE remaining lifetime (see Section 5.8.3.8)

Regardless of the event that causes a node to build and send a PTSP, the actions taken are always the same. Any bundling of PTSEs is done first. The PNNI protocol requires that all PTSEs bundled into a single PTSP for transmission must be originated by a single node.

In general, it is advisable to bundle as many PTSEs as possible into a single PTSP for transmission. However, a node must not build PTSPs which are larger than the maximum packet size allowed on the link that the given PTSP will eventually be transmitted on. A node must also not violate the traffic contract for the given link it is using. This implies that the total number and size of all the PTSPs being queued up on a given link to a given neighbor needs to be monitored and controlled by the sending node. If the sending node reaches the point where it can not send a PTSP immediately to stay within the bounds of the link or the traffic contract, state must be saved so that the needed PTSP update does indeed get sent when conditions permit.

After bundling and encapsulating PTSEs in a PTSP and initializing the PTSP header, the PNNI packet is then passed to the AAL5 service interface for transmission.

No state need ever be saved regarding what PTSEs were bundled together for transmission. Any subsequent retransmission of PTSEs or transmission of new instances of PTSEs can have different PTSP bundling applied. Nodes are permitted to rearrange another node's PTSEs into different PTSP bundles. This is in contrast to the restriction that a node may not rearrange the information inside a PTSE originated by another node.

5.8.3.3 Receiving a PTSP

When a PTSP is received from a neighboring peer, each of the contained PTSEs is examined, by executing the following steps:

- (1) If the PTSE Remaining Lifetime is different from ExpiredAge, the PTSE Checksum is validated. If the checksum is determined to be invalid, processing of the PTSE is complete. Otherwise,
- (2) If the receiving link has neighboring peer state Exchanging or Loading and there is an instance of the PTSE on the receiving link's PTSE request list, compare the received PTSE to the instance on the request list:
 - (a) If the received PTSE is less recent than the instance on the request list, then an error has occurred in the database exchange process. In this case, restart the database exchange process with the neighboring peer by generating the event BadPTSERequest and stop processing the PTSP.
 - (b) Otherwise, delete the PTSE from the receiving link's PTSE request list and continue processing of this PTSE.
- (3) If the node has an instance of the PTSE in its topology database that is more recent than the received PTSE, and
 - (a) the PTSE is found on the receiving link's Peer Retransmission List, then receipt of the PTSE is immediately acknowledged and processing of the PTSE is complete.
 - (b) the PTSE is not found on the receiving link's Peer Retransmission List, then the database copy is encapsulated within a PTSP and flooded to the neighboring peer. The PTSE copy in the PTSP has its PTSE Remaining Lifetime decremented by 1 (unless the PTSE Remaining Lifetime is already equal to ExpiredAge); this breaks any flooding loops that may occur due to implementation errors. Also, the PTSE is added to the neighboring peer's Peer Retransmission List so that the PTSE will be retransmitted until it is acknowledged.

Otherwise,

- (4) If there is an instance in the database, and it is the same instance as the received PTSE, then:
 - (a) If the PTSE is contained on the receiving link's Peer Retransmission List, the flooded PTSE is treated as an implicit acknowledgment. In this case, the PTSE is removed from the receiving link's Peer Retransmission List, and processing of the PTSE is complete. Otherwise,
 - (b) Receipt of the PTSE is immediately acknowledged by sending a PTSE Acknowledgment packet and processing of the PTSE is complete.

Otherwise,

- (5) If there is no database copy, and the received PTSE has PTSE Remaining Lifetime of ExpiredAge, then receipt of the PTSE is immediately acknowledged by sending a PTSE Acknowledgment packet and:
 - (a) If the receiving link has neighboring peer state Exchanging or Loading, the expired-age PTSE is installed in the receiving node's topology database and processing of the PTSE is complete. This is done to avoid a bad PTSE request event under certain race conditions. Otherwise,
 - (b) Processing of the PTSE is complete.

Otherwise,

- (6) Either there is no database copy and the received PTSE is not at ExpiredAge, or the received PTSE instance is more recent than the database copy. In this case, the following steps must be performed:
- (a) If the Originating Node ID is listed as the receiving node itself (i.e., is equal to the receiving node's Node ID) then:
 - (i) If the receiving node has a valid instance of the PTSE, it must reoriginate the PTSE with sequence number one higher than the sequence number in the received PTSE (see Section 5.8.3.7) and processing of the PTSE is complete. Otherwise,
 - (ii) The received PTSE must be flushed from the PNNI routing domain by setting the PTSE Remaining Lifetime to ExpiredAge, installing the expired PTSE in the topology database, and initiating a flood of the PTSE (see Section 5.8.3.8), after which processing of the PTSE is complete.

Otherwise,

- (b) The PTSE is added to the receiving link's Peer Delayed Acks List. In addition,
- (c) The PTSE is installed in the receiving node's topology database. In the process, the former database copy (if any) is deleted from all neighboring peers' Peer Retransmission List and Peer Delayed Acks Lists (including those corresponding to the receiving link). In addition,
- (d) If the level contained in the Originating Node ID is equal to the level of the receiving node and the Originating Peer Group ID is not equal to the Peer Group ID of the node, the processing of the PTSE is complete.

Otherwise,³

- ~~(e)~~ The PTSE is flooded to a subset of all neighboring peers. The following steps are carried out for each neighboring peer:

- (i) If the new PTSE was received from this neighboring peer, examine the next neighboring peer. Otherwise,
- (ii) If the neighboring peer is in a lesser state than Exchanging, it does not participate in flooding, and the next neighboring peer must be examined. Otherwise,
- (iii) If the neighboring peer state is Exchanging or Loading, examine the PTSE request list associated with this adjacency. If there is an instance of the new PTSE on the list, compare the new PTSE to the neighboring peer's copy:
 - If the new PTSE is less recent, then examine the next neighboring peer.
 - If the two copies are the same instance, then delete the PTSE from the PTSE request list, and examine the next neighboring peer.
 - Else, the new PTSE is more recent. Delete the PTSE from the PTSE request list and flood the PTSE to the neighboring peer, as described in step (iv).

Otherwise,

- (iv) The PTSE is encapsulated within a PTSP and flooded to the neighboring peer. The PTSE copy in the PTSP has its PTSE Remaining Lifetime decremented by 1 (unless the PTSE Remaining Lifetime is already equal to ExpiredAge). Also, the PTSE is added to the neighboring peer's Peer Retransmission List so that the PTSE will be retransmitted until it is acknowledged.

5.8.3.4 Processing of Peer Retransmission List

Periodically a node must examine each of its neighboring peer's Peer Retransmission Lists for PTSEs that must be retransmitted. Those PTSEs that were last transmitted more than PTSERetransmissionInterval seconds ago are encapsulated in a PTSP and transmitted to the neighboring peer. The current version of the PTSE in the node's topology database is used for this purpose. The PTSE copy in the PTSP has its PTSE lifetime decremented by one from the current PTSE lifetime value in the database.

5.8.3.5 Sending of PTSE Acknowledgments

According to the procedures described in Section 5.8.3.3, some PTSEs need to be acknowledged immediately, while others can be delayed. The Peer Delayed Acks list holds PTSE acknowledgments that will be sent after a certain delay named PeerDelayedAckInterval. This list is scanned every PeerDelayedAckInterval seconds and if it is not empty, a PTSE Acknowledgment packet containing a number of PTSE identifying information items is generated and sent. Acknowledged PTSEs are deleted from the Peer Delayed Acks list. Note that PTSE acknowledgments on the Peer Delayed Acks list may be transmitted in conjunction with immediate Acks. Guidelines on how to select the PeerDelayedAckInterval are presented in Appendix G.

5.8.3.6 Receiving Acknowledgment Packets

An Acknowledgment Packet contains a list of PTSE identifying information items. They are sent in response to PTSPs (see Steps 3a, 4b, 5, and 6b of Section 5.8.3.3).

When an Acknowledgment Packet is received from a neighboring peer, its encapsulated list of PTSE identifying information items is examined. For each PTSE identifying information item, if the neighboring peer's Peer Retransmission List contains the exact same instance of the PTSE, the PTSE is removed from the Peer Retransmission List.

5.8.3.7 Origination of a New PTSE or a new PTSE Instance

A node initiates the flood of a PTSE when it originates or updates one of its own self-originated PTSEs.

When a node originates a PTSE, or updates a PTSE that it had previously originated, it goes through the following steps:

- I. It decides on a value for the PTSE's PTSE Sequence Number. If:
 - A. this is the first time that the PTSE has been originated, its PTSE Sequence Number is set to InitialSequenceNumber.
 - B. this is in response to receiving a self-originated PTSE during flooding (see Sections 5.7.6 and 5.8.3.3), the next PTSE Sequence Number after that listed in the received PTSE is chosen.
 - C. this is an update of an already existing PTSE, the next PTSE Sequence Number after that listed in the current database copy is chosen.

The "next" PTSE Sequence Number means incrementing the referenced PTSE Sequence Number by 1.

To ensure that the PTSE Sequence Number space is not exhausted too quickly, a node is limited to updating any particular PTSE no more than once every MinPTSEInterval seconds. With the default value of 1 second for MinPTSEInterval, this means that, in the absence of errors, the fastest that the PTSE Sequence Number space will be exhausted is once every 136 years.

- II. The node builds the PTSE contents, describing the appropriate part of the node's environment. Whenever a PTSE is re-originated, the information in all of the information groups in that PTSE must reflect the most current state of the node, whether or not a significant change has occurred in the information group since the last time that PTSE was originated.
- III. The node calculates and installs the PTSE Checksum.
- IV. The node calculates the remaining lifetime of the PTSE by multiplying the PTSERefreshInterval by the PTSELifetimeFactor, and installs the result as the PTSE Remaining Lifetime.
- V. The PTSE is installed in the node's topology database. The former instance of PTSE (if any) is deleted from all neighboring peers' Peer Retransmission Lists and Peer Delayed Ack Lists.
- VI. For each neighboring peer in state Exchanging or greater, the PTSE is encapsulated within a PTSP and flooded to the neighboring peer. The PTSE is also added to the neighboring peer's Peer Retransmission List.

5.8.3.8 Expiration of a PTSE's Lifetime

A PTSE lifetime expires in two ways:

- 1) A node prematurely ages one of its self-originated PTSEs. This is frequently caused by the information in the PTSE becoming invalid.
- 2) One of the PTSEs in the node's topology database naturally ages out (see Section 5.8.4).

Sometimes a node may want to remove one of its self-originated PTSEs from the topology database *before* it naturally ages out. The node sets the PTSE Remaining Lifetime to ExpiredAge. This is called "premature aging". A node is allowed to prematurely age only those PTSEs that the node has itself originated (i.e., those whose Originating Node ID is equal to the node's own Node Identifier).

Whenever the remaining lifetime of a PTSE becomes ExpiredAge (either due to premature or natural aging), the PTSE is flushed. To flush a PTSE, a node performs the following steps:

- I. Delete the PTSE from all neighboring peers' Peer Retransmission Lists and Peer Delayed Ack Lists.
- II. Set the PTSE Remaining Lifetime to ExpiredAge.
- III. Flood the PTSE *without content* (without recalculating the PTSE Checksum, leaving it unchanged from its original value)³ to each neighboring peer in state Exchanging or greater. The expired PTSE is added to the neighboring peer's Peer Retransmission List.
- IV. Once the conditions described in Section 5.8.3.9 are satisfied, the expired PTSE is removed from the topology database.

5.8.3.9 Removal of PTSEs from the topology database

A PTSE must be removed from the logical node's view of the³ topology state database when, and only when, the following conditions are met:

- 1) The PTSE's PTSE Remaining Lifetime is equal to ExpiredAge.
- 2) The PTSE is no longer contained on any of the node's Peer Retransmission Lists ~~or on any of the node's PeerDelayedAcks lists.~~ Optionally the node may wait until the PTSE is no longer on any PeerDelayedAcks lists before deleting the PTSE.¹
- 3) None of the node's neighboring peers are in states Exchanging or Loading.
- 4) If the node is a logical group node, the peer group leader in the child peer group has either no instance of this PTSE in its view of the topology database, or an instance of the PTSE with Remaining Lifetime equal to ExpiredAge.³
- 5) If the PTSE is a remaining lifetime ExpiredAge PTSE instance used for proxy flushing, either the associated Proxy Flushing timer is not running (see Section 5.10.4.1), or this node is no longer peer group leader.³

5.8.3.10 Handling of PTSE sequence number wraparound¹

Under normal circumstances, the 32 bit range of the PTSE sequence number is large enough that the upper limit (all ones) will not be reached; however, faults may cause the sequence number to reach all ones.

If a node needs to originate a new local PTSE and the existing instance has sequence number of all ones, it should follow the procedures given for invalid PTSEs in section 5.10.4 to remove the old instance from the network before originating the new data with a new (low) sequence number. Alternatively, in the case of PTSEs other than the Nodal Info PTSE, the node may flush the old data and originate a PTSE containing the new data using a new PTSE identifier.¹

5.8.4 Aging PTSEs in the Topology Database

PNNI nodes must monitor the age of PTSEs collected in their topology database. The aging function adjusts the PTSE Remaining Lifetime to reflect time elapsed since the PTSE was entered in the topology database. The aging function also detects when self-originated PTSEs are to be refreshed and when non-self-originated PTSEs are to be flushed (i.e. because they have reached ExpiredAge).

PTSEs which have reached ExpiredAge must not be used during route computation.

5.8.4.1 Computing the Remaining Lifetime of a PTSE

The remaining lifetime of a PTSE is determined based on the remaining lifetime of the PTSE when it was installed into the topology database and the time elapsed since then. If the initial remaining lifetime is less than or equal to the elapsed time, then the remaining lifetime must be set to ExpiredAge and the procedures in Section 5.8.3.8 must be followed. Otherwise the remaining lifetime is computed by subtracting the elapsed time from the initial installed remaining lifetime of the PTSE.

5.8.4.2 Refreshing Self-originated PTSEs

When the remaining lifetime of a self-originated PTSE falls below the threshold

$$\text{Initial Lifetime} - \text{PTSERefreshInterval}$$

implying that the PTSE has not been refreshed for at least PTSERefreshInterval, the PTSE is re-originated (see Section 5.8.3.7).

5.8.5 Triggered Updates of Topology Information

PNNI topology information which has not changed and has not been updated must be re-originated periodically to prevent it from aging out of the network. This was discussed in Section 5.8.4.2.

The only other time a PNNI entity will re-originate one of its PTSEs is in response to a significant change event. A significant change to any component of any information group (IG) generates a significant change event for the containing PNNI Topology State Element (PTSE). Such an update made in response to a significant change event is termed a triggered update.

The period between successive re-origination of PTSEs must not be less than MinPTSEInterval. The MinPTSEInterval effectively acts as a hold down timer preventing a node from injecting new PTSEs into the network at unacceptably high rates. Re-origination of the PTSE is done using the procedures specified in Section 5.8.3.7.

5.8.5.1 Significant Change Events for PNNI Topology State Elements

PTSEs contain a variable number of IGs as described in Section 5.14. Addition of a new IG to a PTSE constitutes a significant change event for the containing PTSE. Deletion of an IG from a PTSE constitutes a significant change event. Deletion of the last IG in a PTSE constitutes a significant change event which results in premature aging of the PTSE in question. Finally, a significant change in any IG contained within a PTSE constitutes a significant change to that PTSE.

The definition of significant change to the contents of an IG depends on the type of information in the IG. There are six types of IGs:

- Nodal information
- Internal Reachable ATM Addresses
- Exterior Reachable ATM Addresses
- Nodal State Parameters
- Horizontal Links
- Uplinks

A Resource Availability information group is (sometimes optionally) contained within an IG. Any modification to the contents of the Resource Availability information group is also considered as a modification to the IG contents. Therefore any significant change to an RAIG also constitutes a significant change to the containing PTSE.

5.8.5.2 Processing Significant Changes to PTSEs

When a significant change occurs, if the PTSE was last originated more than MinPTSEInterval time ago it may be re-originated again immediately. If the PTSE in question was originated less than MinPTSEInterval time ago, it must not be re-originated immediately. The originating node must wait until MinPTSEInterval time has passed before re-originating the PTSE in question. Once MinPTSEInterval time has passed since the last origination, the PTSE in question must then be re-originated and flooded according to the flooding procedures specified in Section 5.8.3.7.

The following subsections define what constitutes a significant change for each of the types of top level information groups and RAIGs in a PTSE.

5.8.5.2.1 Changes in Nodal Information Groups

Any change in Nodal Information is a significant change.

5.8.5.2.2 Changes in Internal Reachable ATM Addresses IGs

Any change to an Internal Reachable ATM Addresses IG is a significant change. This occurs when internal addresses transition from reachable to unreachable and vice versa.

The Internal Reachable ATM Address information group optionally contains Resource Availability information groups for each direction for one or more service categories. Changes to the Resource Availability information associated with internal reachable addresses are considered significant according to the same rules as for other Resource Availability information described in Section 5.8.5.2.5.

5.8.5.2.3 Changes in Exterior Reachable ATM Addresses IGs

Any change to an Exterior Reachable ATM Addresses IG is a significant change. This occurs when exterior addresses transition from reachable to unreachable and vice versa.

The Exterior Reachable ATM Address information group optionally contains Resource Availability information groups for each direction for one or more service categories. Changes to the Resource Availability information associated with exterior reachable addresses are considered significant according to the same rules as for other Resource Availability information described in Section 5.8.5.2.5.

5.8.5.2.4 Changes in other information groups

This section addresses changes in the remaining IGs:

- Nodal State Parameters IGs
- Horizontal Links IGs
- Uplinks IGs

Addition or deletion of any of these IGs is a significant change.

Each of these IGs also contains a Resource Availability information group. Any significant change to the Resource Availability information is considered a significant change to the IG.

These IGs contain node, port and peer group identifiers. Any changes to these fields are considered significant. The Horizontal Link and Uplink IGs also contain the Aggregation Token. A change of the Aggregation Token (due to reconfiguration) is a significant change.

The Uplink Information Attribute (ULIA) contains a sequence number which changes only when the remaining contents have undergone a significant change, as defined by the originator of the ULIA. Therefore, for inclusion in an uplink advertisement, a change in the ULIA sequence number is considered significant, and no other change in the ULIA content is considered significant.

5.8.5.2.5 Changes to Resource Availability Information

The subsections below define what changes in the components of an RAIG constitute significant changes.

5.8.5.2.5.1 Administrative Weight (AW)

AW is a required metric. Any change is significant.

5.8.5.2.5.2 Cell Loss Ratio (CLR_0)

CLR_0 is a required attribute. Any change is significant.

5.8.5.2.5.3 Cell Loss Ratio (CLR_{0+1})

CLR_{0+1} is a required attribute. Any change is significant.

5.8.5.2.5.4 Available Cell Rate (AvCR)

Generally speaking, changes in AvCR are more significant as AvCR approaches zero. For example, AvCR transitioning from zero to non-zero values implies that some number of calls can now be carried where none could before; this is certainly a significant change. Likewise, as AvCR transitions from a non-zero value to zero, that implies that no more calls can be carried where some could before; this is certainly significant.

Changes in AvCR are measured in terms of a proportional difference from the last value advertised. A proportional multiplier (AvCR_PM) parameter, expressed as a percentage, provides flexible control over the definition of significant change for AvCR. There is also a minimum threshold (AvCR_mT) parameter, expressed as a percentage of maxCR, which ensures that the range of insignificance is non-zero.

Given a previous value for AvCR the algorithm establishes an upper bound and a lower bound for AvCR values which define a range of insignificance. Any new value for AvCR computed that is within the bounds is not a significant change from the previous value. Any new value for AvCR that is outside the bounds is a significant change. [PTSE advertisements containing the latest AvCR can also be triggered by call blocking as a result of CAC \(See Section 8.5 for more details\).](#)³

The bounds of the range of insignificance are computed using the following algorithm:

```

compute_AvCR_bounds ( PREV_AvCR, maxCR, AvCR_PM, AvCR_mT )
{
  /*
    • PREV_AvCR = previous/currently advertised value for AvCR for
      service category in cells/sec
    • maxCR = Maximum Cell Rate for service category in cells/sec
    • AvCR_PM = proportional multiplier as a percentage
      ( 1 <= AvCR_PM <= 99 )
    • AvCR_mT = minimum threshold as a percentage
      ( 1 <= AvCR_mT <= 99 )
  */

  delta = PREV_AvCR * ( AvCR_PM/100);
  min_delta = maxCR * ( AvCR_mT/100 );

  if ( delta < min_delta ) { delta = min_delta; }

  upper_AvCR_bound = PREV_AvCR + delta;
  if ( upper_AvCR_bound > maxCR )
    { upper_AvCR_bound = maxCR; } /* set upper bound to maxCR */

  if ( delta > PREV_AvCR )
    { lower_AvCR_bound = 0; } /* set lower bound to zero
  */
  else
    { lower_AvCR_bound = PREV_AvCR - delta; }

} /* end compute_AvCR_bounds() */

```

When AvCR changes, the following algorithm is used to determine if the change is significant:

```

/* NEW_AvCR = new value for AvCR */
if (NEW_AvCR <= lower_AvCR_bound ||
    NEW_AvCR >= upper_AvCR_bound)
  { /* change in AvCR is significant */ }
else
  { /* change AvCR is NOT significant */ }

```

5.8.5.2.5.5 Maximum Cell Transfer Delay (maxCTD)

MaxCTD is a required metric. The algorithm used to determine significant change for maxCTD is very similar to the one used above used for AvCR, except that there is no upper limit analogous to maxCR for delay.

Change in maxCTD is measured in terms of a proportional difference from the last value advertised. A proportional multiplier parameter (maxCTD_PM), expressed as a percentages, provides flexible control over the definition of significant change for maxCTD.

Given a previous value for maxCTD the algorithm establishes an upper bound and a lower bound for values which define a range of insignificance. Any new value for maxCTD computed that is within the bounds is not a significant change from the previous value. Any new value for maxCTD that is outside the bounds is a significant change.

The bounds of the range of insignificance are computed using the following algorithm:

```

compute_maxCTD_bounds ( PREV_maxCTD, maxCTD_PM )
{
/*
    • PREV_maxCTD = previous/currently advertised value of maxCTD for
    service category
    • maxCTD_PM = maxCTD proportional multiplier as a percentage
    ( 1 <= maxCTD_PM <= 99 )
*/

delta = PREV_maxCTD * ( maxCTD_PM/100);
upper_maxCTD_bound = PREV_maxCTD + delta;
if ( delta > PREV_maxCTD )
    { lower_maxCTD_bound = 0; }/* set lower bound to zero */
else
    { lower_maxCTD_bound = PREV_maxCTD - delta; }
} /* end compute_maxCTD_bounds() */

```

When maxCTD changes, the following algorithm is used to determine if the change is significant:

```

/* NEW_maxCTD = new value for maxCTD */
if (NEW_maxCTD <= lower_maxCTD_bound ||
    NEW_maxCTD >= upper_maxCTD_bound)
    { /* change in maxCTD is significant */ }
else
    { /* change in maxCTD is NOT significant */ }

```

5.8.5.2.5.6 Cell Delay Variation (CDV)

CDV is a required metric. The algorithm used to determine significant change for CDV is identical to the one used above used for maxCTD.

Change in CDV is measured in terms of a proportional difference from the last value advertised. A proportional multiplier parameter (CDV_PM), expressed as a percentages, provides flexible control over the definition of significant change for CDV.

Given a previous value for CDV the algorithm establishes an upper bound and a lower bound for values which define a range of insignificance. Any new value for CDV computed that is within the bounds is not a significant change from the previous value. Any new value for CDV that is outside the bounds is a significant change.

The bounds of the range of insignificance are computed using the following algorithm:

```

compute_CDV_bounds ( PREV_CDV, CDV_PM )
{
    /*
        • PREV_CDV = previous/currently advertised value of CDV for
        service category
        • CDV_PM = CDV proportional multiplier as a percentage
        ( 1 <= CDV_PM <= 99 )
    */

    delta = PREV_CDV * ( CDV_PM/100);
    upper_CDV_bound = PREV_CDV + delta;
    if ( delta > PREV_CDV )
        { lower_CDV_bound = 0; }          /* set lower bound to zero */
    else
        { lower_CDV_bound = PREV_CDV - delta; }
    } /* end compute_CDV_bounds() */

```

When CDV changes, the following algorithm is used to determine if the change is significant:

```

/* NEW_CDV = new value for CDV */
if (NEW_CDV <= lower_CDV_bound ||
    NEW_CDV >= upper_CDV_bound )
    { /* change in CDV is significant */ }
else
    { /* change in CDV is NOT significant */ }

```

5.8.5.2.5.7 Maximum Cell Rate (maxCR)

MaxCR is a required attribute. Any change in maxCR is significant. Note that maxCR is used to calculate the range of insignificance for AvCR.

5.8.5.2.5.8 Cell Rate Margin (CRM) and Variance Factor (VF)

CRM and VF are optional attributes. Changes in CRM or VF are not considered significant.

5.9 Advertising and Summarizing Reachable Addresses

This section describes the default behavior of a Logical Group Node in summarizing addresses of the Peer Group it represents in the next higher level of the hierarchy. The same behavior applies to a lowest level node with respect to summarizing the addresses of its attached systems.

The term “default summarization rules” implies a recognition that these rules will not serve the needs of all organizations at all times, and that other behaviors may be made available by vendors through configuration options.

5.9.1 Scope of Advertisement of Addresses

The advertisement scope of reachable addresses is specified by a level indicator, which specifies that the address will be advertised up to this level, but not into any higher level of PNNI routing. If the level indicator is set to zero, then the advertisement scope is unlimited, which means that the address may be advertised throughout the PNNI routing domain.

Addresses are eligible for advertisement or summarization into a peer group only if they have a advertisement scope that is higher than or equal to that of the peer group. If there are addresses in the summary with different advertisement scopes, the highest such advertisement scope is advertised with the summary.

The PNNI advertisement scope of an address registered with an organizational scope at the UNI is determined according to a network specific mapping, as described in Section 5.3.6.

5.9.2 Summary Address and Suppressed Summary Address

A summary address is an abbreviation of a set of addresses, represented by an address prefix that all of the summarized addresses have in common. When a node advertises a summary address, calls to any destination matching that summary address (unless the destination address matches a longer address prefix advertised elsewhere) may be routed to that node. This means that an address summary should only be used when all reachable addresses matching this summary are reachable at this node. A node can have an arbitrary number of summary addresses.

A suppressed summary address is used to suppress the advertisement of addresses which match this prefix, regardless of scope. If suppression is configured for a given reachability advertisement, advertisement of that address shall be suppressed regardless of its scope. Advertisements whose scope is sufficiently wide enough to otherwise be advertised at a higher level (i.e., advertisement scope value is smaller than level of this node), will nonetheless be suppressed by such configuration. A node can have an arbitrary number of suppressed summary addresses.

There are separate sets of summary addresses and suppressed summary addresses for internal and exterior reachable addresses. Exterior summary information does not affect advertisement of internal reachable addresses, and internal summary information does not affect advertisement of exterior reachable addresses.

By default a logical group node has one internal summary address which is identical to the Peer Group ID it represents and no suppressed summary addresses. By default, a lowest level node has one default internal summary address (the 13-octet prefix of the node's address), unless the node is at level 104 (in which case it has no default summary address). A node by default has no internal suppressed summary addresses, exterior summary addresses, or exterior suppressed summary addresses. See Section 5.8.1.3 for a discussion of the differences between internal and exterior addresses.

When overlapping summary addresses and/or suppressed summary addresses are present, the longest matching summary address or suppressed summary address shall be used to determine whether an address is to be advertised explicitly, advertised indirectly through use of a summary address, or suppressed. Configuration of duplicate summary and suppressed summary addresses is an error.

5.9.3 Native Addresses

An address is considered native if it matches one of the node's summary addresses. The summary address is advertised; and the address (or more detailed summary address) being summarized is suppressed.

The summary address is not advertised if no match of suitable scope has occurred.

Addresses within the range of a summary address can be used elsewhere in the network. If the address prefixes being advertised by the different parts of the network are of different length, then the longer one will be used for destinations that match it. If they are of equal length, then either may be chosen by call originators. In the latter case, unless all destinations are reachable at both places, this is likely to result in frequent crankback, which is typically undesirable.

When summarizing internal reachable addresses, aggregation of RAIGs associated with the addresses being summarized is done in an implementation specific manner.

5.9.4 Foreign Addresses

An address which does not match any of the summary addresses of a node is assumed to be foreign to that node. If the associated advertisement scope is higher than or equal to the level of the node, the address and the advertisement scope are passed along without further summarization. If the address matches one of the suppressed summary addresses, then the address is not advertised at all.

5.9.5 Group Addresses

When multiple identical group addresses are present, only one address is advertised. In this case, the highest advertisement scope is used. There are no default summary group addresses.

5.9.6 Exterior Reachable Addresses

The PNNI routing protocol allows for exterior reachable addresses to be advertised into a PNNI routing domain.

When summarizing exterior reachable addresses, aggregation of RAIGs associated with the addresses being summarized is done in an implementation specific manner.

5.10 Hierarchy

5.10.1 Peer Group Leader

The PNNI hierarchy requires that a node be selected in each peer group to perform some functions of the LGN. The node selected for this purpose is known as the Peer Group Leader. Preference for peer group leadership is established through configuration. This preference is indicated by the PGL priority advertised by each node. The node ID is used as a tie breaker among nodes with equal PGL priorities.

5.10.1.1 Peer Group Leader Election Algorithm

The PGL election algorithm is used to dynamically select an appropriate node to assume peer group leadership within a peer group or to replace an outgoing PGL. Among all nodes to which a node has connectivity, it must vote for the one with the highest non-zero PGL priority subject to tie breaking using node IDs. The leadership priority is advertised by all nodes in the peer group in PTSEs. If no node advertises a non-zero PGL priority, then no node is selected. A node will consider a 2/3 majority vote sufficient for PGL election after it determines that a unanimous vote cannot be obtained within a sufficient time, so that errant implementations in a small number of nodes in the peer group are not likely to cause a hung election. For a similar reason, all nodes in a peer group must participate in PGL election during normal operation. [The nodal information of all reachable nodes in the peer group is considered for the purposes of PGL election, even when the nodal information PTSE or nodal information IG contains an unknown mandatory information group.¹](#) However, a node that has the Non-transit for PGL Election flag set in its Nodal IG does not participate in PGL election, i.e., it does not run the PGL election FSM and advertises zero for Leadership Priority and Preferred PGL. Such nodes are also not considered by other nodes in the peer group when determining connectivity in the peer group, and the PGL priority and preferred PGL advertised by such overloaded nodes are ignored by all other nodes.

The scope of any references to node, connectivity, or reachability in the following description is within a single peer group. In the case of a partitioned peer group, this means within a single partition.

5.10.1.1.1 The PGL Election Data Structure

Each node has a single Peer Group Leader election data structure, which consists of the following items:

State

The operational status of the peer group leader election FSM. This is described in more detail in Section 5.10.1.1.2.

PreferredPeerGroupLeader

The ID of the node that this node believes should be peer group leader. To select its preferred peer group leader, the node compares the leadership priorities and node IDs advertised in the PTSEs in the topology database for nodes that are reachable from this node. See Section 5.10.1.1.4, action PGL4, for details.

PreferredPGLLeadershipPriority

The leadership priority of the preferred peer group leader.

SearchPeer Timer

An interval timer that fires after InactivityFactor times HelloInterval. When the timer fires the node considers that it has no peer and starts the election process immediately.

PGLInit Timer

An interval timer that fires after PGLInitTime. When this timer fires, the election process starts. The node selects a preferred peer group leader and advertises its selection by originating a new instance of its Nodal Information PTSE. The PGLInit Timer is used to ensure that every node casts a vote only after waiting for a sufficient amount of time for topology information to propagate across the entire peer group.

OverrideUnanimity Timer

An interval timer that fires after OverrideDelay. It is used to prevent nodes from waiting forever for unanimity.

ReElection Timer

An interval timer that is started when connectivity is lost to the PGL and fires after ReElectionInterval. After that time, the election process must restart. The node selects a new preferred peer group leader and advertises its selection in a new instance of its Nodal Information PTSE. The ReElection Timer is used to hold off each node in the peer group from voting for a PGL upon loss of connectivity until the nodes in the peer group have had a chance to receive updated topology information. This improves the stability of the system.

5.10.1.1.2 PGL Election States

The states that the Peer Group Leader election FSM may attain are described in this section. Figure 5-7 shows a diagram of the possible state changes. The arcs are labeled with the events that cause each state change. These events are described in Section 5.10.1.1.3. For a detailed description of the state changes and the actions involved with each state change, see Section 5.10.1.1.4.

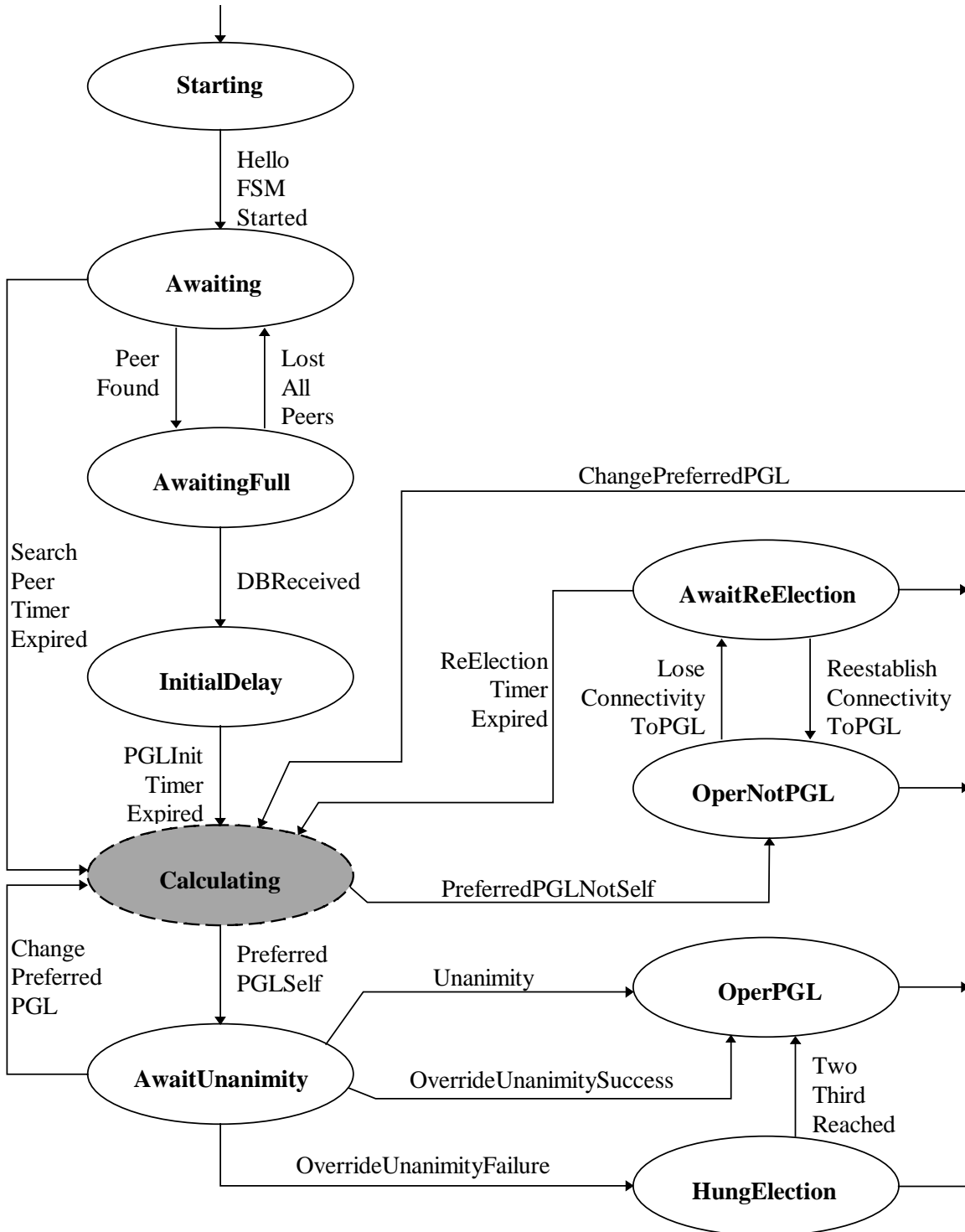

Figure 5-7: PGL Election FSM.

Starting

The initial state of the state machine.

Awaiting

The node has started the Hello FSM on at least one link. No peer has been found yet.

AwaitingFull

At least one neighboring peer has been found. No database synchroniation process has been completed yet.

InitialDelay

Database synchronisation has been completed with at least one neighboring peer and the PGLInit timer has started. The node must wait PGLInitTime before it can select and advertise its preferred PGL.

Calculating

The node is in the process of calculating what its (new) choice for PreferredPGL will be. This is a transitive state; as soon as the node selects its (new) choice for PGL, this state will be exited. The selection is made by executing the ChoosePreferredPGL algorithm detailed below.

The next state transition out of the calculating state depends on whether the node selected itself as PGL, or chose some other node. One of two events is generated to effect the transition:

- i) The PreferredPglNotSelf if some other node was selected.
- ii) The PreferredPglSelf event if the node selected itself.

The algorithm for choosing a preferred PGL is specified in Section 5.10.1.1.6.

OperNotPGL

This node is not Peer Group Leader. It continues examining PTSEs sent by other nodes to determine which node has the highest priority to be PGL.

OperPGL

This node is Peer Group Leader. It continues examining PTSEs sent by other nodes to see if another node has a higher priority than itself.

AwaitUnanimity

The node has chosen itself as Peer Group Leader. Upon entering this state, the node must first immediately check if it has been elected unanimously, and if so generate a Unanimity event. It waits for unanimity or the expiration of the OverrideUnanimity timer before declaring itself peer group leader.

HungElection

The node has chosen itself as Peer Group Leader, but, after the OverrideUnanimity timer has fired, less than 2/3 of the other nodes are advertising it as their preferred PGL. This may come from a change in the topology or the parameters of the network. In that case, the situation will recover by itself, i.e., either this node is going to change its choice of preferred Peer Group Leader, or the other nodes are going to accept it as PGL. This situation may also be the result of a defective switch or link.

AwaitReElection

The node has lost connectivity to the current PGL. The ReElection timer has been started. If connectivity has not been reestablished before the timer fires, the election is redone.

5.10.1.1.3 Events Causing PGL Election Neighboring Peer¹ State Changes

State changes can be brought about by several possible events. These events are brought about by procedures associated with Peer Group Leader election, especially the reception of a PTSE that contains a nodal information group. They may also be triggered by developments within the Hello state machines and the Neighboring Peer state machines. The events are shown as the labeled arcs in Figure 5-7. A detailed explanation of the state changes and actions taken after an event occurs is given in Section 5.10.1.1.4.

HelloFSMStarted

The first Hello state machine has started on a link.

PeerFound

A Hello state machine has reached state 2-Way Inside.

LostAllPeers

The last remaining Hello state machine that was in state 2-Way Inside has left that state.

SearchPeerTimerExpired

The SearchPeer timer has fired. No peer has been found. The Peer Group Leader election starts immediately.

DBReceived

A Neighboring Peer state machine has reached state Full.

PGLInitTimerExpired

The PGLInit timer has fired. The node can now select and advertise its preferred Peer Group Leader.

PreferredPGLNotSelf

Having entered the Calculating state, the node determines that its preferred PGL is not itself. This happens if its leadership priority equals zero or a peer has a higher priority.

Unanimity

The node's preferred PGL is itself, and all other reachable nodes in the peer group now indicate in their PTSEs that their preferred PGL is this node. Note that the preferred PGL advertised by each reachable node in the peer group is considered when counting votes, even when the nodal information PTSE or nodal information IG contains an unknown mandatory information group.¹

OverrideUnanimitySuccess

The OverrideUnanimity timer has fired. The node's preferred PGL is itself. 2/3 or more of other reachable nodes in the peer group indicate in their PTSEs that their preferred PGL is this node. Note that the preferred PGL advertised by each reachable node in the peer group is considered when counting votes, even when the nodal information PTSE or nodal information IG contains an unknown mandatory information group.¹

OverrideUnanimityFailure

The OverrideUnanimity timer has fired. The node's preferred PGL is itself. Less than 2/3 of other reachable nodes in the peer group indicate in their PTSEs that their preferred PGL is this node. Note that the preferred PGL advertised by each reachable node in the peer group is considered when counting votes, even when the nodal information PTSE or nodal information IG contains an unknown mandatory information group.¹

TwoThirdReached

The node's preferred PGL is itself. 2/3 of other nodes in the peer group now indicate in their PTSEs that their preferred PGL is this node.

PreferredPGLSelf

Having entered the Calculating state, the node determines that it should be PGL.

ChangePreferredPGL

New information is received that changes this node's choice of preferred PGL (for example, a new high priority node appears; the current PGL lowers its priority; or management raises this node's priority to be higher than that of the current PGL).

LoseConnectivityToPGL

Connectivity to the Peer Group Leader has been lost.

Note: Determination of whether a node has connectivity to the PGL (or any other node for the purpose of running the PGL election) requires a special route computation. Specifically, it must determine whether there is connectivity to the PGL by ignoring resource and policy constraints on the links within the peer group. All links that are advertised by the nodes at both ends and all nodes advertised in the peer group must be considered for evaluating PGL connectivity, except for nodes which have the Non-transit for PGL Election flag set in their nodal flags. For example, it must use nodes and links with access controls, transit restrictions, zero remaining AvCR or unknown mandatory information groups in order to determine if connectivity exists to the current PGL.

ReestablishConnectivityToPGL

Connectivity to the Peer Group Leader has been reestablished.

ReElectionTimerExpired

The ReElection timer has fired. The election must be redone.

LGNEnabled

The logical group node becomes operational.³

5.10.1.1.4 The PGL Election State Machine

The finite state machine is a two dimensional table with States across the top of the table and Events down the left side. Each pairing of event and state crosses at a "cell" in the table. The cell shows what state transition should occur and the action to take. For example, for the event and state pair of "HelloFSMStarted" and "Starting" the cell reads "PGL1, Awaiting". "Awaiting" is the new state and "PGL1" is the Action to be taken. The actions can be found following table.

Table 5-14: PGL Election FSM Part 1.

<i>Events</i>	<i>States</i>				
	Starting (Note 1)	Awaiting	AwaitingFull	InitialDelay	Calculating
Hello FSM Started	PGLE1 Awaiting	FSM ERR	FSM ERR	FSM ERR	FSM ERR
Peer Found	FSM ERR	PGLE2 AwaitingFull	PGLE0 AwaitingFull	PGLE0 InitialDelay	PGLE0 Calculating
Lost All Peers	FSM ERR	FSM ERR	PGLE3 Awaiting	PGLE0 InitialDelay	PGLE0 Calculating
SearchPeer Timer Expired	FSM ERR	PGLE4 Calculating	FSM ERR	FSM ERR	FSM ERR
DB Received	FSM ERR	FSM ERR	PGLE5 InitialDelay	PGLE0 InitialDelay	PGLE0 Calculating
PGLInit Timer Expired	FSM ERR	FSM ERR	FSM ERR	PGLE4 Calculating	FSM ERR
Preferred PGL Not Self	FSM ERR	FSM ERR	FSM ERR	FSM ERR	PGLE7 OperNotPGL
Unanimity	FSM ERR	FSM ERR	FSM ERR	FSM ERR	FSM ERR
Override Unanim.Success	FSM ERR	FSM ERR	FSM ERR	FSM ERR	FSM ERR
Override Unanim. Failure	FSM ERR	FSM ERR	FSM ERR	FSM ERR	FSM ERR
Two Third Reached	FSM ERR	FSM ERR	FSM ERR	FSM ERR	FSM ERR
Preferred PGL Self	FSM ERR	FSM ERR	FSM ERR	FSM ERR	PGLE9 AwtUnanimity
Change Preferred PGL	FSM ERR	FSM ERR	FSM ERR	FSM ERR	FSM ERR
Lose Connectivity To PGL	FSM ERR	FSM ERR	FSM ERR	FSM ERR	FSM ERR
Reestablish Connectivity To PGL	FSM ERR	FSM ERR	FSM ERR	FSM ERR	FSM ERR
ReElection Timer Expired	FSM ERR	FSM ERR	FSM ERR	FSM ERR	FSM ERR
<u>LGNEabled³</u>	<u>PGLE1 Awaiting</u>	<u>FSM ERR</u>	<u>FSM ERR</u>	<u>FSM ERR</u>	<u>FSM ERR</u>

Note 1: For purposes of the PGL Election FSM description, it is assumed that the PGL Election FSM is instantiated before the first Hello FSM is started.

Table 5-15: PGL Election FSM Part 2.

<i>Events</i>	<i>States</i>				
	OperNotPGL	OperPGL	AwtUnanimity	HungElection	AwtReElection
Hello FSM Started	FSM ERR	FSM ERR	FSM ERR	FSM ERR	FSM ERR
Peer Found	PGLE0 OperNotPGL	PGLE0 OperPGL	PGLE0 AwtUnanimity	PGLE0 HungElection	PGLE0 AwtReElection
Lost All Peers	PGLE0 OperNotPGL	PGLE0 OperPGL	PGLE0 AwtUnanimity	PGLE0 HungElection	PGLE0 AwtReElection
SearchPeer Timer Expired	FSM ERR	FSM ERR	FSM ERR	FSM ERR	FSM ERR
DB Received	PGLE0 OperNotPGL	PGLE0 OperPGL	PGLE0 AwtUnanimity	PGLE0 HungElection	PGLE0 AwtReElection
PGLInit Timer Expired	FSM ERR	FSM ERR	FSM ERR	FSM ERR	FSM ERR
Preferred PGL Not Self	FSM ERR	FSM ERR	FSM ERR	FSM ERR	FSM ERR
Unanimity	FSM ERR	PGLE0 OperPGL	PGLE8 OperPGL	PGLE8 OperPGL	FSM ERR
Override Unanim. Success	FSM ERR	FSM ERR	PGLE8 OperPGL	FSM ERR	FSM ERR
Override Unanim. Failure	FSM ERR	FSM ERR	PGLE0 HungElection	FSM ERR	FSM ERR
Two Third Reached	FSM ERR	PGLE0 OperPGL	PGLE0 AwtUnanimity	PGLE8 OperPGL	FSM ERR
Preferred PGL Self	FSM ERR	FSM ERR	FSM ERR	FSM ERR	FSM ERR
Change Preferred PGL	PGLE4 Calculating	PGLE6 Calculating	PGLE4 Calculating	PGLE4 Calculating	PGLE4 Calculating
Lose Connectivity To PGL	PGLE10 AwtReElection	FSM ERR	FSM ERR	FSM ERR	FSM ERR
Reestablish Connectivity To PGL	FSM ERR	FSM ERR	FSM ERR	FSM ERR	PGLE11 OperNotPGL
ReElection Timer Expired	FSM ERR	FSM ERR	FSM ERR	FSM ERR	PGLE4 Calculating
LGNEnabled³	FSM ERR	FSM ERR	FSM ERR	FSM ERR	FSM ERR

FSM ERR [Represents an internal implementation error.¹](#)

~~—Action:—Protocol error, should not occur.~~

PGLE0

Action: Do nothing.

PGLE1

Action: The SearchPeer timer is started with initial value InactivityFactor times HelloInterval.

PGLE2

Action: The SearchPeer timer is stopped.

PGLE3

Action: The SearchPeer timer is restarted, with initial value InactivityFactor times HelloInterval.

PGLE4

Action: The OverrideUnanimity timer is stopped if it is running. The ReElection timer is stopped if it is running. The node re-evaluates the value of its PreferredPeerGroupLeader, as described in Section 5.10.1.1.6.

PGLE5

Action: The PGLInit timer is started, with initial value PGLInitTime. The node originates a PTSE that contains a nodal information group in order to advertise its leadership priority. The "I am leader" bit is set to 0. The Preferred peer group leader node ID is set to 0.

PGLE6

Action: The node stops behaving as PGL and deactivates its parent LGN by performing the following actions:

- A new instance of the Nodal Information PTSE must be originated. The Preferred Peer Group Leader ID field is updated, according to the procedures given in action PGLE4. The node must advertise its original leadership priority and turn off the "I am leader" bit.
- For each PTSE being proxy flushed by this PGL (as defined in Section 5.10.4.1), the ExpiredAge PTSE instance used for proxy flushing remains in this logical node's view of the topology until the ExpiredAge PTSE instance can be removed (see Section 5.8.3.9).³
- Initiate the process of deactivating the LGN. That process involves the following actions:
 - If the parent LGN is PGL of its peer group, it stops behaving as PGL by performing action PGLE6 at its level.
 - The procedures from Section 5.5.6.3 item C for a node which ceases to be PGL are performed.
 - The parent LGN stops feeding PTSEs into the child peer group.

PGLE7

Action: If the preferred Peer Group Leader is different from the previously advertised one, a new instance of the Nodal Information PTSE must be originated with the new preferred Peer Group Leader ID and the "I am leader" bit set to zero.

PGLE8

Action: The node starts to behave as PGL by taking the following actions:

- The node increases its leadership priority by GroupLeaderIncrement. This higher priority is used in future calculations regarding who is PGL.
- Stop the OverrideUnanimity timer if it is running.
- A new instance of the Nodal Information PTSE is originated with the updated leadership priority and the "I am leader" bit set to 1 to indicate that the node is claiming to be Peer Group Leader. The higher level peer group is also included in the PTSE.
- The parent LGN is instantiated, causing the following to happen in due time:
 - The parent LGN establishes SVCC-based RCCs to neighboring peer nodes in the parent peer group as described in Section 5.5.
 - Once the peer group election is complete in the higher level peer group, the results are included in the next higher level binding information in the nodal information PTSE of this node. If multiple nodes claim to be PGL in the parent peer group, information is only included about the node selected locally as higher level PGL.
 - PTSEs received from higher level peer groups are flooded into this peer group.

Note: The "I am leader" bit allows border nodes to know when the PGL is (believed to be) stable, and can be announced in Hellos sent to outside neighbors. The increase in leadership priority associated with becoming peer group leader provides some increased stability with respect to who is PGL.

PGLE9

Action: A new instance of the Nodal Information PTSE must be originated with the preferred Peer Group Leader ID set to this node's ID and the "I am leader" bit set to zero. The OverrideUnanimity timer is started, with initial value OverrideDelay.

Note: If all nodes are unanimous in their choice of this node as PGL at the time of this action, the origination of the new Nodal Information PTSE is optional as there will be an immediate transition into state OperPGL and consequently another Nodal Information PTSE will be generated.

PGLE10

Action: The ReElection timer is started, with initial value ReElectionInterval.

PGLE11

Action: The ReElection timer is stopped.

5.10.1.1.5 Sending a Nodal Information PTSE

At the beginning of the peer group leader election, the node must originate a PTSE that contains a nodal information group. This PTSE must be re-originated either when a change occurs or regularly to prevent it from aging out of the network.

In states Awaiting, AwaitingFull and InitialDelay, and when the node has the Non-transit for PGL Election flag set, the preferred peer group leader node ID field must be set to zero. Furthermore, if the node has the Non-transit for PGL Election flag set, it must set the Leadership Priority to zero. In states Calculating, AwaitUnanimity, AwaitReElection, OperNotPGL, OperPGL and HungElection the field must be set to PreferredPeerGroupLeader in the data structure (see action PGLE4 in Section 5.10.1.1.4).

The "I am leader" bit must be set only in state [OperPGL](#)¹.

5.10.1.1.6 Choosing Preferred PGL

Each time a node receives and accepts a PTSE that contains a nodal information group, it must re-evaluate the value of its PreferredPeerGroupLeader. The node also re-evaluates its PreferredPeerGroupLeader whenever connectivity to another node in the peer group is established or is lost.

[For purposes of choosing the PreferredPeerGroupLeader, the nodal information group of each reachable node in the same peer group must be considered, even if an unknown mandatory information group was contained in the nodal information group.](#)¹

The node compares the leadership priority value of all reachable nodes in the peer group (including itself). It should be noted that nodes which appear in the database, but to which there is no connectivity (by the rules for determining connectivity stated above in the description for the LoseConnectivityToPGL event), as well as nodes with peer group leadership priority zero, are not considered in this comparison. [An exception is made when the node is in the AwaitReElection state, in which case the current peer group leader is considered to be reachable.](#)³

The node with the highest leadership priority is selected as preferred PGL. If there are no reachable nodes in the peer group with a leadership priority different from zero, the preferred PGL ID is set to zero. The Node ID is used as the tie-breaker. For this purpose, the 22-octet Node ID is treated as an unsigned integer with the first octet of the Node ID as the most significant octet. In the case of a tie, the node with the highest value of the Node ID from among the set with the highest leadership priority is selected as preferred PGL.

It should be noted that a node must consider only information received directly from other nodes. In particular, the preferred PGL advertised by other nodes must not affect this node's choice of preferred PGL.

5.10.1.2 Leadership Priority

The peer group leadership priority is a value between 0 and MaxLeadership. It is assigned to indicate the relative preference for this node to become PGL.

5.10.1.2.1 Group Leader Increment

To allow for flexibility and stability, when a node concludes that it will be operating as peer group leader (i.e., when it enters PGL Election FSM state OperPGL and sets the "I am leader" bit), it increments its advertised peer group leadership priority by the constant GroupLeaderIncrement.

5.10.1.2.2 Distinguished Values and Range Restrictions

The priority value 0 is reserved for a node which is either unwilling or unable to become peer group leader.

No node shall select as peer group leader a node which is advertising a priority of 0. If all nodes in a peer group are advertising priority 0, the behavior described in Section 5.10.1.4 shall be followed.

No node shall be configured with a leadership priority value greater than MaxLeadership minus GroupLeaderIncrement. Note that an active PGL advertises the configured priority plus GroupLeaderIncrement.

5.10.1.2.3 Range Recommendations

In peer groups where there is no node that must be forced to be peer group leader, peer group leadership priority for nodes which can become leader should be assigned in the range 1 to GroupLeaderIncrement-1.

In situations where certain nodes should take precedence over nodes in the first tier (even if one of them is already PGL), the nodes that are to take precedence should be assigned a leadership priority between $2 * \text{GroupLeaderIncrement}$ and $3 * \text{GroupLeaderIncrement} - 1$. Within this tier of nodes, precedence will still defer to the existing peer group leader to produce stability.

Finally, if it is necessary to have a strict master leader, that node should be assigned a leadership priority between $4 * \text{GroupLeaderIncrement}$ and $(\text{MaxLeadership} - \text{GroupLeaderIncrement})$. This will produce a value which will take precedence over the second tier of leaders, and still be incrementable.

5.10.1.2.4 Implications of Hierarchy

There is no implicit correlation between the peer group leadership priorities of two nodes at two different levels of the hierarchy instantiated in the same switching system. There is a requirement that a switching system may only become PGL if it exists as a node within a given peer group. This does mean that it must be the leader of all lower level peer groups of which it is a member. Therefore, when a node is preempted as PGL at some level of the hierarchy, all ancestor nodes of that node instantiated in the same switching system cease to exist. If any of these ancestor nodes were PGL, this forces a new PGL election in the corresponding peer groups. Note that the PGL leadership priorities of a switching system can be different at each level of the hierarchy.

As a special case of the above, not all peer group leaders are necessarily willing to become higher level peer group leaders. If a node does not know the higher level peer group identity, it must not become leader. It may also choose, for local reasons, to be unwilling to become higher level leader. In either case, the node advertises a leadership priority of 0 at that level of the hierarchy.

5.10.1.3 Default Configuration Consistency

The default configuration for a node shall have a leadership priority of 0.

Note: This is compatible with the notion that lowest level nodes may be autoconfigured, but that higher level nodes require some (limited) amount of active configuration, since a peer group leader must know the peer group hierarchy.

5.10.1.4 Operation Without a Peer Group Leader

The behavior specified in this section also applies prior to completion of the peer group leader election.

Operation without a peer group leader is a normal mode of operation for networks which are small enough to operate as a single peer group, without the need for a hierarchy. It also applies at the highest level of the hierarchy.

Internal operation of the peer group does not depend on the existence of a peer group leader. Thus, in the absence of a peer group leader, internal operation of the peer group continues normally. Nodes must transmit PNNI Hellos, and determine their local topology including identification of which of their neighboring nodes are in the same peer group. PTSPs must be transmitted and received normally within the peer group. Routes internal to the peer group are calculated, and connections may be setup in the peer group.

Because there is no peer group leader in the peer group, higher level information cannot be passed into the peer group. The peer group does not take part in the operation of higher levels of PNNI routing within the same contiguous PNNI routing domain. Nodes in a leaderless peer group are permitted to advertise exterior reachability information and such information may be used to reach destinations outside the routing domain.

Border nodes in a leaderless peer group continue to exchange Hellos on their outside links. Since there is no higher level information, an empty nodal hierarchy list is transmitted. This precludes the Hello state machine from reaching Common Outside state. Thus such links will not be used for the establishment of connections.

5.10.1.5 Exchange of Nodal Hierarchy Information on Outside Links

Once a Peer Group Leader has been elected and has advertised that fact by setting the "I am Leader" bit to 1 in its Nodal Information PTSE, border nodes include Higher Level Binding information received from the PGL in their nodal hierarchy list in Hellos exchanged with outside neighbors.

If multiple nodes claim to be peer group leader of this peer group, border nodes advertise the information from the one selected locally as peer group leader. For higher-level peer groups, if multiple nodes claim to be PGL, border nodes advertise the information from the one selected by the ancestor LGN in that peer group, as reported in the next higher level binding information in the Nodal Information group received from that LGN.

If the next higher level binding information group advertised by an ancestor contains an unknown mandatory information group within it, then that information must be ignored for computation of nodal hierarchy lists.¹

5.10.2 Advertising Uplinks

When an uplink advertisement is generated and injected into a peer group, it must contain topology state parameters for both directions so that PNNI can consider the links during path selection. These topology state parameters are acquired as follows.

5.10.2.1 Advertising Uplinks from Lowest Level Nodes

When the nodes at the ends of an outside link discover that the other node is in a different peer group, they must include Resource Availability information for the outbound direction in their Hello Packets. A ULIA is included in the Hello Packet to carry this information.

The topology state parameters to exchange here are identical to the topology state parameters that would appear in the advertisement for that link if it were internal to the peer group. The only difference is that they are carried in a Hello Packet rather than in PTSEs.

Since Hellos never propagate across more than one link, the topology state parameters can be bound by the receiver to the outside link corresponding to the port on which the Hello is received. No extra binding information is required. The topology state parameters received in the Hellos on that port are for the inbound direction of that outside link.

As the hierarchy boots, outside links become the basis for uplinks. The uplinks are advertised into the peer groups of the border nodes at each end of the outside links. The border nodes use the topology state parameters for the inbound directions on the outside links as the basis for calculating topology state parameters for the inbound (i.e., downward) direction of the uplinks. Thus, the border node which injects the uplink advertisement into a peer group specifies the topology state parameters for both directions.

Individual uplinks may be generated for each outside link. In this case, the topology state parameters received in a Hello are advertised unchanged for the corresponding uplink. Alternatively, a single uplink may be an aggregation of several outside links. The procedures for such aggregation are exactly the same as those used to aggregate links in general.

5.10.2.2 Reverse Direction Information in Uplinks

Uplink advertisements are derived from either outside links or other uplinks.

For uplinks derived from outside links, reverse direction information (including topology state parameters) is specified by the outside neighbor node. Border nodes identify the information that the outside neighbor is to include as reverse direction information in its uplink advertisements, by including an Uplink Information Attribute (ULIA) in the Hello sent over the outside link. The ULIA in Hellos encloses the complete set of information to be advertised in the uplink advertisement that the receiving outside neighbor generates.

Uplinks may also be derived from other uplinks. This case occurs when one or more border nodes in a child peer group are advertising an uplink to an upnode which is at a higher level than this LGN's peer group. In this case, the LGN advertises a resulting uplink to the same upnode. The details of how the LGN determines whether or not to aggregate multiple lower level uplinks into one higher level uplink are explained in Section 5.10.3.1.

In the case where ~~an uplink is derived from a single outside link or inducing uplink a lowest-level node generates a separate uplink for each outside link~~, the Uplink Information Attribute contained in the Hello received on the outside link ~~or advertised for the inducing uplink, respectively,~~³ must be copied into the advertisement for the derived uplink (independent of the tags on the information groups contained within the ULIA).

In the case where ~~a lowest-level node is capable of aggregating multiple outside links or with the same derived aggregation token and the same upnode into a single uplink, or when an uplink is derived from one or more inducing uplinks exist~~ to the same higher level node, ~~the following procedures apply, these multiple links may be aggregated into a common uplink from this node (see Section 5.10.3.1). In that case, the~~³ information groups contained in the ULIA being generated for the aggregate uplink are derived (aggregated) from the set of individual information groups enclosed in ULIA's contained in the Hellos received on the outside links or advertised for the inducing uplinks, respectively. Whether any unknown information groups contained in the ULIA's being aggregated are included in the advertisement for the resulting uplink is controlled by the information group tags associated with those information groups (see Section 5.14.2 for details). Since this node is constructing the topology state parameters being advertised for the aggregated uplink, it is also responsible for indicating when there is a significant change in the values it has constructed. This means that it has to generate appropriate values for the ULIA sequence number for the aggregated uplink.

Nodes can only use uplinks in their route computations and specify them in DTLs if they understand all mandatory information groups of the uplink. In addition, as an exception to the normal rules for the scope of tags, the node must also understand all mandatory information groups inside the ULIA of the uplink. For example, if there exists an information group inside the ULIA wrapper that is unrecognized and tagged as mandatory the corresponding link must not be used by route computation.

5.10.3 Topology Aggregation

Topology aggregation is the process of summarizing the topology information of a child peer group to reduce the volume of information advertised in the parent peer group. Effective aggregation is required to allow PNNI to scale to support large networks.

Link aggregation is the process of representing several parallel links as a single higher-level link. The topology state parameters for such a link are derived from those for the individual links being aggregated.

The PNNI complex node representation is a flexible scheme for describing the connectivity within a logical node. When a logical group node produces a complex node representation, it makes a tradeoff between the accuracy of that representation and its size. Alternatively, it may use the simple node representation, in which the entire LGN is treated as a point, with no resource constraints.

The algorithms used to derive the aggregated topology description are implementation specific.

5.10.3.1 Link Aggregation and Binding Information

Aggregation of a set of outside links between the same two peer groups is configured through the Aggregation Token values in the border nodes at which the outside links in question terminate. The information about link aggregation is configured into border nodes rather than logical group nodes to ensure consistent behavior when peer group leaders change. All links between a pair of logical group nodes with the same value of the Aggregation Token must be advertised by the LGNs as one logical link. The scope of an Aggregation Token is limited to links between one pair of logical group nodes. The same token value may be used for links between other pairs of nodes without confusion.

The aggregation token is communicated in the Hello protocol between two lowest level neighbor nodes connected by an outside link. The value of the token in Hellos between two lowest level neighbor nodes does not change unless it is reconfigured. This value is referred to as the Configured Aggregation Token in the subsequent text.

Once the configured aggregation tokens have been exchanged, each lowest level neighbor node runs the same algorithm on the same information to determine common values of the Derived Aggregation Token, which is the value advertised in PTSEs for the corresponding uplinks. Whereas Hellos between lowest level nodes include the value of the configured aggregation token, PTSEs and Hellos between logical group nodes always include the value of the derived aggregation token.

The derivation process was designed with minimal configuration in mind, as well as acceptable behavior in the face of misconfiguration. By default a link has the configured aggregation token value of zero, which has special significance. Any other value is established through configuration. The distinguished value zero conveys the meaning that the link does not care about aggregation behavior. In that case, the node will use as the derived aggregation token value whatever value the remote end has. If no configuration is done then all links will end up with a derived aggregation token value of zero.

The algorithm for computing the value of the derived aggregation token is:

1. If neighbors exchange identical values of the configured aggregation token, that value is the derived aggregation token value.
2. If the configured aggregation token value of one neighbor is zero, and that of the other neighbor is non-zero, the non-zero value is the derived aggregation token value.
3. If the configured aggregation token values of the neighbors are different and both non-zero, the derived aggregation token value is zero.

To effect disaggregation, at least one end of the link needs to be configured. If all links have zero configured aggregation token values, then only one end of a link need be reconfigured to cause disaggregation of that link.

The above algorithm runs continuously. When a change of the configured aggregation token takes effect, the new value is communicated immediately in the outside Hellos to the lowest level neighbor node. If this causes any change in the derived aggregation token value, new instances must be issued of all PTSEs containing links affected by the change in the derived aggregation token value. Note that this may cause an immediate change in the aggregation of links all the way up the hierarchy.

For lowest level nodes, uplinks to the same higher level neighbor node with the same derived aggregation token value may be aggregated or disaggregated in any manner desired by that node. However, uplinks with different derived aggregation token values must not be aggregated. If the lowest level node has a neighbor at the same level that is a logical group node, then all horizontal links to that logical group node with the same derived aggregation token value must be aggregated and advertised as a single link.

For logical group nodes, all links to the same neighbor node with the same derived aggregation token value must be aggregated and advertised as a single link. That is, if a peer group has multiple uplinks to the same upnode with the same derived aggregation token value, then the logical group node representing the peer group must aggregate these uplinks into a single uplink or horizontal link.

Since the default value of the configured aggregation token is zero, the default behavior is to aggregate all links between two logical group nodes into a single link with derived aggregation token value zero.

The derived aggregation token value together with the remote node ID serves as the binding information between levels of the hierarchy. These values are communicated in PTSEs that describe uplinks or horizontal links. The values advertised in uplink PTSEs are used by the parent of this node to make further aggregation decisions at the next higher level of the hierarchy. In addition, the values advertised for either uplinks or horizontal links are used by border nodes during DTL processing. When an entry border node processes a received DTL stack with a non-zero port ID in the current entry of the topmost DTL, the selected path across this peer group must end at an uplink that was aggregated into the link indicated by that port ID (i.e., the uplink exiting the peer group has the same aggregation token value as that of the port ID specified in the DTL).

For consistency of format the derived aggregation token field is also carried in the horizontal link PTSEs for physical links and VPCs. This token must be set to zero upon transmission. Since there are no inducing uplinks below this horizontal link, the aggregation token value advertised for this horizontal link has no effect.

5.10.3.2 Simple Node Representation

The end-to-end QoS and traffic parameter values of a connection are affected by each of the nodes and links traversed by that connection. For cases where traversal of a node affects the end-to-end parameter values of connections insignificantly, it is simplest to model such a node as a single point. This representation allows for relatively quick routing computation by reducing the representation of the network topology to one with nodes represented as vertices and links represented as arcs. This representation is particularly useful for modeling lowest-level nodes implemented on single switches, where the limitations of the links attached to the node are much more significant than the limitations of the switch itself. For coding of the simple node representation, see Sections 5.8.1.2.3 and 5.14.9.1.

5.10.3.3 Complex Node Representation

A complex node representation is a collection of nodal state parameters that provide detailed state information associated with a logical node. It is used to express the case where traversing into or across a node has a significant effect on the end-to-end parameter values of connections.

To accommodate traversing a logical node as well as routing to the “inside” of the node, a symmetric star topology with a uniform “radius” is used. The center of the star is the interior reference point of the logical node, and is referred to as the nucleus. The logical connectivity between the nucleus and a port of the logical node is referred to as a spoke. PNNI Routing supports a default node representation, which consists of a single value for each nodal state parameter, giving a presumed value between any entry or exit of the logical node and the nucleus, in either direction.

For each nodal state parameter associated with a logical node, a “radius” is derived from the “diameter” of the logical node. For a nodal metric, the “radius” is simply half the “diameter”. For a nodal attribute, the “radius” is the same as the “diameter”. PNNI Routing does not specify exactly how the aggregation is taken to determine the “diameter”. A conservative advertiser may take worst case values. Aggressive advertisers may consider the average case, or even the best case.

The default node representation offers the greatest reduction of advertised information (short of using the simple node representation). However, it cannot fully capture the multiple connectivity in a typical logical node or reflect asymmetric topology information.

Given that a logical node is in general not perfectly round, PNNI Routing permits the topology state parameters associated with any given spoke to be different from the default “radius”. In addition, direct port-to-port connectivities (called a “bypasses”) may also be advertised.

With this flexibility, one may advertise practically any aggregated topology ranging from a symmetric star to a full mesh. A connectivity advertisement that represents something other than the default node representation is called an exception.

The complex node representation for PNNI Routing can be constructed as described below:

1. Conceptually overlay on each logical node a star topology with a nucleus representing the “inside” of the corresponding node, and spokes connecting the ports of the logical node to the nucleus. Each port ID must be the same as the port ID used to identify the link or reachable addresses associated with the port.
2. For each nodal state parameter, advertise a “radius” to be used as the default value for the spokes.
3. Any spoke or any logical connectivity between a pair of ports may be designated as an “exception”.
4. For each such “exception”, advertise the entire set of nodal state parameters associated with it. For bypasses, nodal state parameters must be specified in both directions.
5. For each spoke advertised as an exception, the exception nodal state parameters supersede the default information in the directions in which the exceptions are specified.
6. A path through the logical node is obtained from a concatenation of any number of bypasses and at most two spokes (default or exception) in the complex node representation.

With the above complex node representation, one may choose to advertise conservatively or aggressively depending on parameter values assigned to the “radius” and “exceptions”.

PNNI Routing does not specify how spokes and bypasses are selected to be advertised as exceptions. Some guidelines are provided in Appendix C.

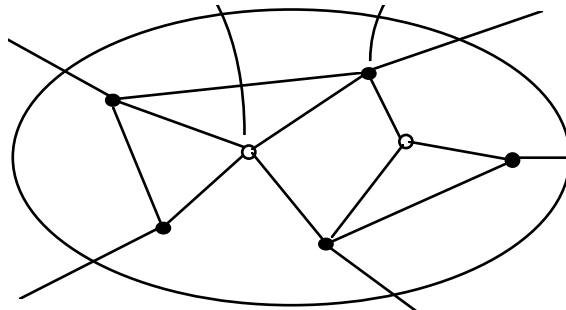

Figure 5-8: Peer Group with Five Border Nodes

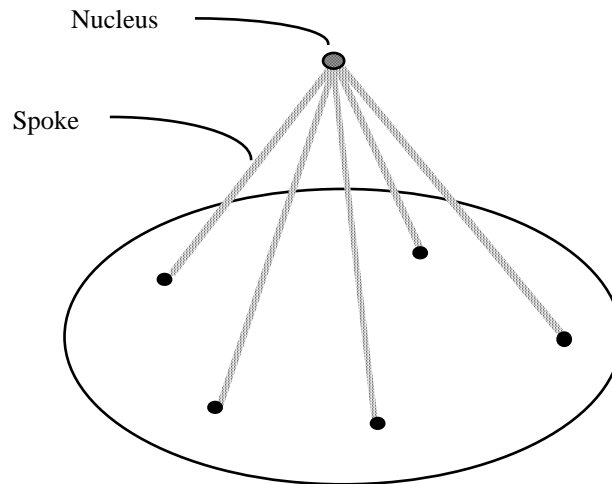

Figure 5-9: Default Node Representation

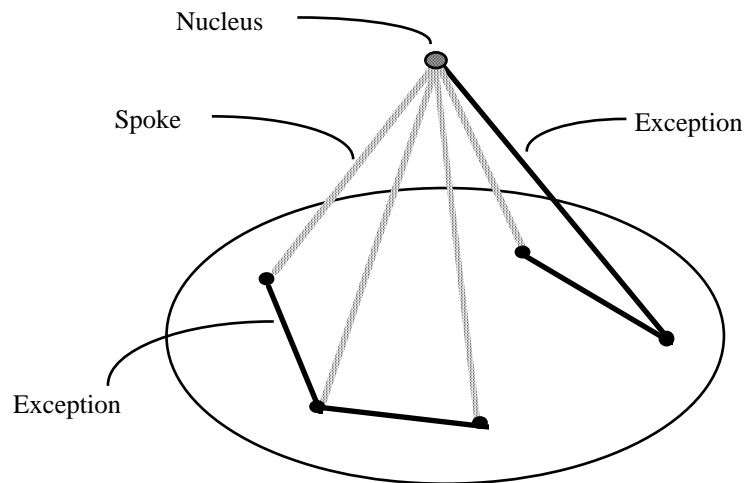

Figure 5-10: Complex Node Representation with Exceptions

5.10.4 Feeding Information Down the Hierarchy

The hierarchical summarization described above allows nodes in the highest level of the hierarchy to calculate routes to any destination represented in the highest level peer group (including systems reachable via lower levels, which are announced via summary address prefixes). However, it is necessary for all nodes in the PNNI network to be able to route calls to any destination, not just nodes actually at the highest level of the hierarchy. This implies that the topological information describing the higher levels of the hierarchy must be available to the lower level nodes.

This requires that all nodes participating in PNNI routing maintain information in their topology databases (and the capability of calculating routes) not only for their own peer group, but also for all of their ancestor peer groups.

The higher level PTSEs are flooded to all nodes of their peer group, and in addition are flooded to all nodes of all descendant peer groups, allowing all nodes to directly calculate appropriate routes (even those nodes which are not explicitly represented in the summarized higher level topology).

Some PTSEs originated by a higher level node contain information groups that are not needed by the nodes of its descendant peer group. To avoid the storage of unnecessary information groups in the nodes of its descendant peer groups, a higher level node that originates a PTSE containing Nodal State Parameter information groups or PAR Service information groups is not required to flood the PTSE to the nodes of its descendant peer groups. The higher level node must however flood the PTSE to its neighboring peers at its level.³

Flooding of PTSEs to all nodes of all descendant peer groups (i.e., to all lower-level nodes contained in the lower-level peer groups represented by the nodes in this peer group, and so on), is achieved as follows:

- When originating a new PTSE or updating a PTSE that it had previously originated, a higher-level node floods the PTSE to the PGL of the peer group that the higher-level node represents, as well as the usual process of flooding to all neighboring peers at its level. The higher level node is not required to flood a self-originated PTSE to the PGL of the peer group that it represents if the PTSE contains:³
 - Nodal State Parameter information groups.
 - PAR Service information groups.

When a PTSE is flooded from the higher level node to its underlying PGL, the PGL will in turn flood the PTSE in the child peer group.
- When flooding a received PTSE that is new or more recent than its topology database copy, a higher-level node floods the PTSE to the PGL of the peer group that the higher-level node represents, as well as the usual process of flooding to all neighboring peers at its level other than the one from which the PTSE was originally received. The PGL will in turn flood the PTSE in the child peer group.

PTSEs generated in a given peer group never get flooded to the next higher level peer group. Instead, the peer group leader summarizes the topology of the peer group based on the PTSEs generated within the peer group, but the summary is flooded in new PTSEs originated by the LGN at the parent peer group's level.

When a logical group node is first enabled, its view of the topology database consists logically of those PTSEs contained in the underlying peer group leader's topology database that are at the level of the logical group node or at a higher level. As the logical group node creates adjacencies, these PTSEs are described in the Database Summary packets transmitted by the logical group node. It is an implementation dependent matter whether the topology database is shared between the peer group leader and its parent logical group node, or whether these PTSEs are copied from the peer group leader's topology database into a separate database for the logical group node, or whether any other scheme is used to satisfy this requirement.³

5.10.4.1 **Proxy Flush³**

Under normal circumstances the peer group leader has the most current instances of PTSEs generated at higher levels. There are abnormal cases, however, in which PTSEs generated at a higher level exist in a given peer group with sequence numbers larger than the current ones. One possible scenario is when a node in a lower-level peer group is isolated from the rest of the peer group while some PTSEs known to the isolated node are prematurely aged, flushed and re-originated by a node in a higher-level peer group. When the isolated lower-level peer group gets reconnected to the rest of the lower-level peer group, it may still have old copies of the PTSEs with possibly invalid information and sequence numbers that are larger than the most current ones.

In such a case, the peer group leader will eventually get the invalid PTSEs and realize that the PTSEs ~~are~~ might be incorrect. The peer group leader detects that such a received PTSE might be invalid when:

- The PTSE is received from a neighboring peer node.³
- The PTSE is encapsulated in a PTSP where the level of the PTSE's originator's logical node ID is higher (smaller in value) than the level of the peer group that the PGL belongs to, and
- Either the PGL has no instance whatsoever ~~in its database~~ of the PTSE in question in its view of the topology database, or the received³ PTSE is determined to be more recent than the peer group leader's database copy.

These cases apply both to the reception of a PTSE, and to the reception of a database summary packet announcing the existence of such a PTSE.¹

When such a PTSE is detected, the peer group leader begins the proxy flush procedures. The proxy flush procedures use a Proxy Flushing timer for each PTSE being proxy flushed. The Proxy Flushing timer interval is equal to TimeToFlush, where TimeToFlush determines the length of time to perform a proxy flush for such a PTSE. There is one TimeToFlush value associated with each PTSE. TimeToFlush remains associated with a PTSE, even after completion of the proxy flush procedures. The first time such a PTSE needs to be proxy flushed, the TimeToFlush interval for that PTSE is set to MinTimeToFlush.³

When such a PTSE is detected, the following actions are taken: ~~flushes the PTSE~~

- a) Flush the received PTSE instance from ~~in~~ the peer group by setting the PTSE Remaining Lifetime to ExpiredAge and the PTSE sequence number to that in the received PTSE, and flooding it this ExpiredAge PTSE throughout the peer group. If the PGL had no copy of the PTSE in its database, the PGL need not take any further action. Otherwise processing continues as follows.

~~The peer group leader needs to keep in its view of the topology database both that a copy and of the ExpiredAge PTSE instance being flushed, until the this ExpiredAge PTSE flushed PTSE instance can be removed (see Section 5.8.3.9). The ExpiredAge PTSE instance must not be seen in the topology database as viewed from the parent logical group node or any other ancestor node instantiated in the same switching system. If an instance of the PTSE exists in the LGN's view, it must not be seen in the topology database as viewed from the PGL or any other descendent node instantiated in the same switching system. Having initiated the flush the PGL determines an appropriate initial amount of time to wait before attempting to flood its valid (but still less recent) instance by multiplying the number of nodes in its peer group by PTSERetransmissionInterval, and assigns this number of seconds to a variable called TimeToFlush. It then starts a timer that will fire after TimeToFlush seconds have elapsed, and waits for it to fire. If the PGL receives the PTSE it is trying to flush again via flooding with something other than ExpiredAge before the timer fires, it again initiates flushing and restarts the timer with a new value. The new value to use is the lesser of double its previous value and 8 times PTSERetransmissionInterval times the number of nodes in the peer group. If the previous value was already 8 times PTSE RetransmissionInterval times the number of nodes in the peer group, an error should be logged to network management. The number of nodes in the peer group means the number of nodes that are connected as defined for the PGL election (see Section 5.10.1.1). If the timer expires, then the valid upper level PTSE is re flooded into the peer group.~~

- b) If the remaining lifetime in the received PTSE is other than ExpiredAge, set the value of TimeToFlush to MinTimeToFlush and start the Proxy Flushing timer with initial value TimeToFlush, otherwise,
- c) When the remaining lifetime in the received PTSE is equal to ExpiredAge, start or restart the Proxy Flushing timer using the current value of TimeToFlush. If the value of TimeToFlush is equal to MaxTimeToFlush, then an error should be logged to the network management system.

When an ExpiredAge PTSE instance is received at the level of an ancestor node and it is the same as the ExpiredAge PTSE instance being used for proxy flushing in the peer group leader's view of the topology database, if the Proxy Flushing timer is running, it is disabled.

When a PTSE instance is received at the level of an ancestor node and it is more recent than the ExpiredAge PTSE instance being used for proxy flushing in the peer group leader's view of the topology database, in addition to following the normal flooding procedures, if the Proxy Flushing timer is running, it is disabled. As part of the normal flooding procedures, the more recent PTSE instance received at the level of the ancestor node is installed in the peer group leader's view of the topology database, replacing the ExpiredAge PTSE instance used for proxy flushing.

When a PTSE instance is received at the level of an ancestor node and it is less recent than the ExpiredAge PTSE instance being used for proxy flushing in the peer group leader's view of the topology database, the PTSE shall not be installed in the peer group leader's view of the topology database, even if it is installed in the ancestor's view of the topology database.

When the Proxy Flushing timer expires, if the node is still peer group leader the following actions are taken:

- 1) set TimeToFlush for the PTSE being proxy flushed to the lesser of double its previous value and MaxTimeToFlush,
- 2) if the ExpiredAge PTSE instance in the peer group leader's view of the topology database satisfies all conditions for removal,
 - i) remove the ExpiredAge PTSE instance from the peer group leader's view of the topology database, and
 - ii) if the parent logical group node's view of the topology database contains an instance of the PTSE, install this instance in the peer group leader's view of the topology database and flood it to the rest of the peer group in the normal manner,

Otherwise,

- 3) restart the Proxy Flushing timer using the current value of TimeToFlush.³

5.10.4.2 Flushing PTSEs in a Multi-Level Hierarchy³

5.10.5 Flushing PTSEs in a Multi-Level Hierarchy

As described in Section 5.8.3.8, a PTSE is flushed either when its originator decides to prematurely age the PTSE due to the information in the PTSE becoming invalid or when the PTSE naturally ages out, i.e., its PTSE Remaining Lifetime reaches ExpiredAge.

When a node flushes one of its own PTSEs, it follows the procedures described in Section 5.8.3.8 to flood the expired PTSE to its neighboring peers at its level. In addition, if the node is not at the lowest level of the hierarchy, it floods the expired PTSE to the PGL of the peer group that this node represents, provided that this PTSE had been flooded to the PGL when it was originated by the node (see Section 5.10.4)³. The PGL in turn floods the expired PTSE in the child peer group, and so on, as described in Section 5.10.4.

When a PTSE ages out (the PTSE necessarily belongs to another node), the logical node within the switching system that originally received the PTSE must flush the PTSE. This ensures that a widest scope of flushing is achieved. To flush a PTSE, a node follows the flushing procedures described in the previous paragraph.

Note: The PNNI specification does not specify how an implementation organizes PTSEs into databases. In an implementation, it may be possible for logical nodes within a switching system to age out a PTSE independently of one another. The requirement stated above does not preclude logical nodes other than the one which originally received the PTSE from flushing the expired PTSE as well. In this case, TimeToFlush must be set to MinTimeToFlush and the Proxy Flushing timer must be started with initial value TimeToFlush.³

There are cases where a PGL receives an expired PTSE that was originated at a higher level from within the peer group while its own database copy of the PTSE has not yet been aged out. These cases are handled similarly to the abnormal cases discussed in Section 5.10.4. The difference is that when the PGL receives the flush, it does not "reflush" the PTSE, but instead it forwards the flushed PTSE as usual, ~~keeps both the expired copy and its own database copy,~~ sets the Proxy FlushingTimeToFlush³ timer and follows the rest of the procedures as described in Section 5.10.4.

5.11 Peer Group Partitions

A partitioned peer group is a peer group which has been accidentally split into two or more non-contiguous pieces. This may happen due to failure of equipment (such as failure of links or switches).

Each partition operates independently as a peer group. For example each partition elects a peer group leader. This implies that at the next higher level the partitioned peer group appears as multiple logical group nodes (assuming that each partition does elect a PGL). Each partition must be represented correctly and unambiguously in the hierarchy, and the routing computation must operate correctly in the presence of multiple partitions of a peer group.

5.11.1 Representation of the partition in the hierarchy

Each partition elects a peer group leader (PGL). The PGL election algorithm ensures that if a peer group partitions then each partition will elect its own PGL (assuming that there is a node capable of being PGL). Similarly, if a partitioned peer group re-attaches, then only one node will remain as PGL. The PGL is responsible for determining the identity of the parent peer group, and representing the partition in the parent peer group.

In some cases, partitions may have no peer group leader (for example, a small partition might not contain any nodes capable of acting as peer group leader). In this case the partition operates as a “leaderless peer group”, as described in Section 5.10.1.4, and is effectively isolated from the rest of the PNNI routing domain.

In order for the parent peer group to operate correctly, each node in the parent peer group must have a unique node ID. This can be achieved by including the peer group leader’s 48-bit ESI into the “flat ID” part of the node ID (see Section 5.3.3). This ensures that when a partition occurs, each partition is automatically represented in the parent peer group by a logical group node with a unique node ID. This does require that each node which is capable of being PGL must have a 48-bit ESI which is unique within its parent peer group. If alternative methods for creating node IDs are used they must provide for the creation of unique IDs in presence of partitions.

Note: There is a danger that the ESIs will not be unique, especially in higher-level peer groups that span countries.

5.11.2 Routing in the Presence of Partitions

Given that each partition of a peer group is treated as a separate peer group, routing within the parent peer group naturally routes calls around and across the various partitions. Similarly, calls originated within the partitioned peer group to destinations outside of the peer group are correctly routed.

There is a potential problem with routing calls to destinations within the partitioned peer group.

In many cases the set of end systems reachable in a peer group will be summarized using a single address prefix (or a small number of address prefixes). The problem with a partitioned peer group is that each partition may be advertising the ability to reach the same prefix, where in fact only some (not all) of the systems whose addresses match the prefixes are in any one particular partition. This implies that routing to a system within the partitioned peer group may end up in the wrong partition. The entry border node of a partitioned peer group will determine whether the destination address specified for the call is in fact reachable in its partition. If not, and if the same summary address is advertised elsewhere in the network (presumably by another partition) then the call is cranked back and the DTL Originator can construct a new DTL to another partition. Refer to Annex B for details.

5.11.3 What to Aggregate as Peer Group Leader

PTSEs are labeled with the peer group ID of the peer group in which they were generated. All partitions of a peer group have the same peer group ID. Thus, when a peer group has become partitioned, the topology databases of the nodes contain PTSEs from nodes in their own partition, plus (possibly out of date) PTSEs from nodes in other partitions.

When an LGN aggregates and/or summarizes the topology state information of its child peer group (partition), it must only use the topology state information that pertains to its own partition of its child peer group. Similarly, when running the Peer Group Leader election algorithms, a node is restricted to considering only those nodes in its own partition. The algorithm for determining which subset of PTSEs belongs to a node’s own partition (i.e., PTSEs that were originated by nodes to which this node has connectivity) is specified in Section 5.10.1.

5.12 Operation of a Node when in a Topology Database Overload State

A node is said to be in a topology database overload state when it is unable to store the complete topology database it is required to maintain by the normal PNNI algorithms. This would happen if there is insufficient memory in the node to store all the PTSE data currently active in the peer group (including any PTSEs that describe ancestor peer group topology).

While a node in a topology database overload state is not able to operate fully as a normal PNNI node, it is nevertheless desirable for it to continue operating normally in most respects, consistent with the requirement that such operation must not drastically disrupt the correct operation of other nodes in the network. This section describes requirements and recommendations for operation while in a topology database overload state.

5.12.1 Requirement for operation in topology database overload state

5.12.1.1 Minimum state required

A node is allowed to continue operating, under the rules stated here, even when it can store only a small subset of the topology database. However, it must at all times be able to store and advertise the following:

1. All required state describing the node itself
2. All topology state describing the links to its neighbors

If it cannot meet requirement (1), the node must halt. If it cannot meet requirement (2), it must not bring up links for which it cannot store the associated state.

5.12.1.2 Disallowed Functions

When in topology database overload state, the following restrictions apply to the normal operation of the node:

1. The node shall not bring up an outside link. Instead, it shall act in the same way as a node that does not support being a border node. See Section 5.6.2.1.4, in particular Note 1 on the state machine table.
2. The node shall not act as a DTL originator (i.e., no new outgoing calls are permitted).

5.12.1.3 PGL election

When in this state, a node must advertise that fact by setting the Non-transit for PGL Election flag in its nodal flags. It must also stop its PGL election FSM, and instead advertise zero as its Leadership Priority and its Preferred PGL.

5.12.1.4 PTSP reception and transmission

In PTSP reception, PTSE acknowledgements must still be sent according to the normal rules in Section 5.8.3.3. This applies whether or not the node is able to store the PTSEs in question. This requirement ensures that the neighbor node's PTSP transmission process requires no more resources (link bandwidth, retransmit list space) than under normal operation.

The node must, as a minimum, continue to originate and flood in the normal manner PTSEs describing its own state and that of any of its active links.

5.12.1.5 Periodic resynchronization

In order to recover from transient network faults that cause topology database overload, the node must periodically attempt to resynchronize with its neighbors. It does this by restarting all its Neighbor Peer FSMs (as if a DSMismatch event had occurred). This causes database synchronization to be performed with each neighbor.

If the database synchronization process completes and the node was able to store all PTSEs, it returns to normal operation by clearing the Non-transit for PGL Election flag in its nodal flags, and returning to normal execution of the PNNI algorithms. Otherwise, the node remains in topology database overload state.

The periodic resynchronization is done at an interval given by the architectural constant OverloadRetryTime.

5.12.2 Recommendations for operation in topology database overload state

This section gives recommendations for other aspects of operation while a node is in topology database overload state. Adoption of these recommendations in an implementation will result in minimizing the adverse impact of database overload on the operation of the rest of the network.

5.12.2.1 Call processing

The discussion below assumes that memory required for the topology database is separate from that used by call and connection state. If this is not the case, then the implementation should at least reserve some minimal amount of call state memory in order to support incoming network management access.

Calls existing at the time the node entered into topology database overload state should be preserved to the extent possible.

New calls should also be permitted to the extent possible. In particular, it is important to accept calls that terminate at this node, since remote in-band network management access needs to be able to establish SVCCs to the overloaded node.

Transit calls should be handled normally, since this can be done by obeying the DTL in the SETUP message.

~~DTL origination (for call origination or entry border node processing) is necessarily inaccurate since the topology database is incomplete. However, it is still useful to allow it, since routes calculated using the incomplete topology database are still valid (though they may be suboptimal).¹~~

5.12.2.2 Topology database handling

A node in topology database overload state should store whatever subset of the currently active PTSEs it has space for. While it is legal-allowed to keep only a minimal topology database, the disruptive effect on other nodes in the network is reduced by keeping as much as possible of the active PTSEs. Any PTSEs actually stored in the topology database should of course be transmitted to neighbors according to the normal rules for PTSP transmission.

A consequence of the above rules is that a node in topology database overload state may cause a peer group to become partitioned, in the sense of having two peer group leaders. In such a case, the node in database overload state will be considered a member of both partitions at the same time. Since PTSEs may still be exchanged from one partition to another through the node in database overload state, it ~~even though it is~~ may still be possible to set up calls from one partition to another through that node. This situation is peculiar but desirable, since the alternate would be to treat the overloaded node as “restricted transit” and force all calls from one partition to another to be routed via other peer groups, which may not be allowed by the remaining topology. ~~If that were done, all calls from one partition to another would have to be routed via other peer groups, as described in Section 5.12.2, but the topology that remains may not allow this to be done.³~~

5.13 Path Selection

When selecting a route to a destination ATM address, a node shall always route to the node which has advertised the longest prefix which matches the destination. If the only nodes with the longest matching prefix are ancestors then the destination is not reachable. Only when several nodes have advertised equal length matching prefixes which are all longer than any other advertisement may the calculating node choose on a local basis which destination to use. Of the nodes advertising equal longest matching prefixes ignore any ancestors and select among the remaining ones, if any. Note: Scope checking takes precedence over longest match.¹

PNNI allows for point-to-point connections to be established to group addresses (i.e., the ATM Anycast capability). In this case, a route shall be selected to one of the members of the group (this functionally is a consequence of application of the longest match rule to group address advertisements). This group member must be reachable within the indicated connection scope.

All addresses (individual as well as group addresses) have an advertisement scope. When constructing a path a node must ensure that the destination address has an advertisement scope at least as wide as the scope of the path across the PNNI routing domain. The process of address advertisement and summarization ensures that addresses are not advertised beyond their scope; therefore this check has no affect at the DTL originator, but it does have an effect at an entry border node. This implies that scope checking must be done by the entry border node when selecting a specific destination within the final peer group of the current DTL. Specifically the scope checking takes precedence over longest prefix match checking.

When a Transit Network Selection information element is present in the SETUP message, a call is routed to a node that has reachability to the Transit Network specified in the Transit Network Selection information element. In this case, path selection is based on the specified Transit Network Selection; optionally the destination address may also be considered. Nodes that have access to a particular transit network are advertised as such by Transit Network ID information groups included in Exterior Reachable Address information groups. Given multiple advertisements for the same transit network, the RAIG(s) and/or reachable addresses associated with the transit network may be used to select among entrances to that transit network.

In case the same transit network is reachable by many nodes it might be disadvantageous (more expensive) to leave the PNNI network at the nearest node. However, as a particular geographical area may be overlaid by the different networks it may even be more disadvantageous to leave at the more remote node. No specific help can be provided by PNNI [Phase 11.0](#) on this matter.

In the case of path selection for point to multipoint connections, the node shall select a path so that the [reachable branches of the resulting connection is-form](#) a tree. No two branches of a point to multipoint connection may have a link in common, nor may they have a node in common other than the node at which they branch, [except when one of the branches cannot accept new parties at the time when the other branch is first specified. One example of a case where a branch cannot accept new parties is when the identity of a logical group node along the path changes due to a change in the underlying peer group leader.](#) (Note that the effect of this rule is that a node is required to keep track of the tree representation of a point to multipoint connection, rather than keeping track only of the leaves. [All pending parties must be considered part of the tree. A party is considered part of the tree as soon as a route for the corresponding SETUP or ADD PARTY message is determined, and stops being part of the connection tree when the party is rejected or dropped.](#))¹

Note that when parallel links exist, the above constraint prevents more than one of the links from being used for a given point-to-multipoint call because if more than one parallel link were used, then the call must have branched earlier and reconverged on this horizontal link or uplink.

PNNI Routing provides a mechanism that prevents a point-to-multipoint tree from branching at nodes which cannot support additional branching. These nodes are advertised as Restricted Branching nodes, and a point-to multipoint path selection must avoid using these nodes for branching.

Note that maximum number of elements in a DTL (currently 20) and the maximum number of DTLs in a SETUP message (currently 10) impose limits on the diameter of peer groups and the number of levels of hierarchy respectively. [In addition, the limit on the sum of the lengths of the DTL information elements allowed in a SETUP message \(see Figure 6-8\) provides an upper bound on the number of logical nodes that may be specified in a hierarchically complete source route.](#)³

5.13.1 Eligible Entities for Path Selection

When computing paths across a PNNI routing domain, paths are chosen across a concatenation of PNNI entities. These entities include nodes and ports and the horizontal links, uplinks, spokes and bypasses across complex nodes that connect them, and/or routes from nodal ports to their internal and exterior reachable addresses and transit networks. For horizontal links and for spokes and bypasses across complex nodes, each entity is eligible for inclusion in a path if it has been advertised by both endpoints, with a set of topology state parameters for the requested service category advertised by each endpoint for its outgoing direction. For internal and exterior reachable addresses and transit networks, the presence of a PTSE including an advertisement to the reachable address or transit network is sufficient to make it eligible (topology state parameters are optional for exterior reachable addresses and transit networks). If internal or exterior reachable addresses or transit network selection information includes topology state information, it is only eligible for inclusion if it supports the requested service category. A service category is supported either if topology state parameters are absent for all categories or present in both directions for that particular category.

For a horizontal link to be considered, it must have been advertised by both ends of the link. Advertisements from two ends are considered to describe the same horizontal link only if the remote node ID of each matches the local node ID of the other and the remote port ID of each end matches the local port ID of the other.¹

For an uplink to be considered when computing paths from border nodes to other nodes, the uplink must have been advertised in an uplink PTSE including one set of topology state parameters for each direction, and supporting the requested service category. For an uplink to be considered when computing paths from DTL Originators across a PNNI routing domain, there is an additional constraint: a corresponding horizontal link must have been advertised from an ancestor of the node computing the path to the upnode. This is required to ensure that routes computed across the uplink are based on current information about the topology across and beyond the upnode. Additionally, the horizontal link information is required for the computation in order to know at what port the upnode is being entered. For example, if there is no SVCC-based RCC between the two neighboring peer LGNs, it is possible that the topology across and beyond the upnode has changed significantly since the last PTSEs about this topology were received. This can result in excessive failure of call setup messages bound for destinations beyond the upnode. The requirement for a corresponding horizontal link when choosing routes from the DTL Originator is only relaxed when computing routes between LGNs, for the purpose of establishing SVCC-based RCCs between the LGNs.

5.13.2 Link Constraints, Node Constraints, and Path Constraints

PNNI routing shall determine paths that satisfy performance constraints, but are not necessarily optimized with respect to any predetermined performance criteria. Performance constraints may be implemented in one of three ways: link constraints, node constraints and path constraints. For link constraints, non-additive link-state parameters are used. For node constraints, non-additive nodal state parameters are used. For path constraints, additive link-state parameters are needed. Link constraints and node constraints are used to prune the network graph during path selection. PNNI routing supports link constraint and node constraint implementation of Cell Loss Ratio and generic CAC parameters (i.e., Available Cell Rate, Cell Rate Margin, and Variance Factor). PNNI routing supports restricted-transit and restricted-branching node constraints. PNNI routing supports path constraint implementation of Administrative Weight, Maximum Cell Transfer Delay, and Cell Delay Variation.

5.13.3 CLR Selection for CBR and VBR Service

Connection requests for the CBR, rt-VBR and nrt-VBR service categories may specify a CLR objective. Depending on the combination of bearer class, traffic parameters, and QoS parameters the objective may relate to either CLP_0 or CLP_{0+1} traffic. The rules for determining which CLR objective applies are specified in Annex 9 of [the UNI Signalling 4.1 specification-4.0³](#). The CLR objective for a given connection request is compared to the appropriate advertised CLR from links and nodes according to these rules.

5.13.4 Generic CAC Algorithm for CBR and VBR Services

5.13.4.1 Parameter Choice for GCAC

In the generic CAC described below, a connection is characterized by two traffic parameters: PCR and SCR. These two parameters are derived from traffic parameters specified in the ATM Traffic Descriptor IE. Table 5-7 in UNI 3.1 (p. 208) defines the following six allowable combinations of traffic parameters in the ATM User Cell Rate IE for CBR and VBR service categories (PCR = peak cell rate, SCR = sustainable cell rate, MBS = maximum burst size):

1. PCR(CLP=0); PCR(CLP=0+1)
2. PCR(CLP=0); PCR(CLP=0+1); tagging requested
3. PCR(CLP=0+1); SCR(CLP=0); MBS(CLP=0)
4. PCR(CLP=0+1); SCR(CLP=0); MBS(CLP=0); tagging requested
5. PCR(CLP=0+1)
6. PCR(CLP=0+1); SCR(CLP=0+1); MBS(CLP=0+1)

Combinations 1 and 3 produce the same traffic behavior as combinations 2 and 4, respectively. So, GCAC must ignore the “Tagging” subfield.

For any topology element along a candidate path, if the RAIG CLP bit is set to 0, this indicates that it allocates resources based on CLP=0 traffic. In that case, PCR and SCR values of the connection used in GCAC are set according to the following table:

Table 5-16: PCR and SCR values for CLP=0

Parameter Combination	PCR	SCR
1, 2	PCR (CLP=0)	PCR (CLP=0)
3, 4	PCR (CLP=0+1)	SCR (CLP=0)
5	PCR (CLP=0+1)	PCR (CLP=0+1)
6	PCR (CLP=0+1)	SCR (CLP=0+1)

For any topology element along a candidate path, if the RAIG CLP bit is set to 1, this indicates that it allocates resources based on CLP=0+1 traffic. In that case, PCR and SCR values of the connection used in GCAC are set according to the following table:

Table 5-17: PCR and SCR values for CLP=0+1¹

Parameter Combination	PCR	SCR
1, 2, 3, 4	PCR (CLP=0+1)	PCR (CLP=0+1)
5	PCR (CLP=0+1)	PCR (CLP=0+1)
6	PCR (CLP=0+1)	SCR (CLP=0+1)

5.13.4.2 Complex GCAC

Having selected the values for the parameters from the call to use in evaluating whether the selected link has sufficient bandwidth, the GCAC is used to perform the comparison. When CRM and VF are advertised for a given link, this complex GCAC is the recommended algorithm to use.

5.13.4.2.1 Algorithm

Note: Refer to Appendix B for a derivation of this algorithm.

- Step 1. If $AvCR(i) \geq PCR$, include the link, stop
 Step 2. If $AvCR(i) < SCR$, exclude the link, stop
 Step 3. If $[AvCR(i)-SCR]*[AvCR(i)-SCR+2*CRM(i)] \geq VF(i)*SCR(PCR-SCR)$,
 include the link
 Else
 exclude the link.
 Endif
 Step 4. Stop

5.13.4.2.2 Special Cases

Note that if $PCR=SCR$ (i.e., if SCR is not specified in the Traffic Descriptor IE), only Steps 1 and 2 above need to be performed, i.e., Steps 1 and 2 always give a conclusive answer and so Step 3 is not needed in this case.

Note also that in the extreme case where the advertised CRM and VF are zero, Step 3 will always result in "include". In the other extreme where the advertised $VF(i) = \text{infinity}$, Step 3 will always result in "exclude".

5.13.4.2.3 Optional Improvement to Algorithm

In the case multiple connection requests have to be handled in between PTSEs, the values of $CRM(i)$ and $AvCR(i)$ can be optionally updated locally to reflect the newly established connections. When any of these connections is taken down before a new PTSE is received, $CRM(i)$ and $AvCR(i)$ need to be updated, too. This option, however, is to be used with extreme caution as it can result in inconsistent views of the network between different nodes.

5.13.4.3 Simple GCAC

If only $AvCR$ is advertised, use of the simple GCAC is recommended. the S-GCAC algorithm is:

- Step 1. If $AvCR \geq C$, include the link, stop
 Else exclude the link, stop
 where C is given by (let $x = PCR/SCR$)
 if $(x > 39)$ $C = SCR * (0.0145 * x + 4.22)$;
 else if $(x > 5)$ $C = SCR * (0.042 * x + 3.14)$;
 else $C = SCR * (0.48 * x + 0.52)$.

The following algorithm may also be used as the S-GCAC algorithm.

- Step 1. If $AvCR \geq C$, include the link, stop
 Else exclude the link, stop

Where C is given by***

<u>if $(PCR \leq 4*SCR)$,</u>	<u>$C = (PCR + SCR) / 2$</u>
<u>else if $(PCR \leq 16*SCR)$</u>	<u>$C = PCR/8 + 2*SCR$</u>
<u>else if $(PCR \leq 64*SCR)$</u>	<u>$C = (3*PCR + 465*SCR) / 128$</u>
<u>else</u>	<u>$C = (13*PCR + 4413*SCR) / 1024$</u>

Both Simple GCAC algorithms are piecewise linear approximations of the following equation:¹

$$C = SCR * (1 + \ln(PCR/SCR))$$

5.13.5 Generic CAC Algorithm for Best-Effort Service

For UBR connections, a link/node is included if and only if the UBR service category is supported and Maximum Cell Rate is not equal to zero.

For ABR connections, a link/node is included if and only if the ABR service category is supported, Maximum Cell Rate is not equal to zero, and the advertised Available Cell Rate for the ABR service category is greater than or equal to the Minimum Cell Rate specified by the connection.

5.13.5.1 Minimum Acceptable ATM Traffic Descriptor

If there is a Minimum Acceptable ATM Traffic Descriptor with a peak cell rate in the call, then that peak cell rate is compared with the advertised Maximum Cell Rate for determining admissibility of the call.

5.14 Packet Formats

The packet formats specified in this section have been designed to provide a flexible and expandable encoding for PNNI routing packets. In particular, they rely on the use of nested type-length-value (TLV) encodings. Each TLV entity is referred to as an information group. The type and length fields are each two octets long, in all information groups. The four most significant bits of the type field are used for encoding information group tags. Type values need only be unique among all possible type values that may occur at the same positions. Note that for PNNI Phase +1.1 the type values have been assigned in a globally unique manner, in order to make it easier for humans to determine the identity of each TLV information group. The value of the length field includes the lengths of the type and length fields (two octets each) as well as that of the value (the remainder of the information group).

Note that each TLV information group is arbitrarily extensible for future versions of PNNI routing. In particular, after the fixed fields at the beginning of the value part of each information group, several child TLV information groups may appear. Type values are only understood within the context of the containing information group, and their semantics are independent of the sequence in which they occur¹. Specifically, even with the current globally unique assignment of type values, a type that is not defined to occur within a containing IG shall be treated as unknown rather than assuming the global definition. If any of these child information groups is not understood, its effect upon interpretation of the parent information group is determined by the values of the information group tags encoded in the type field of the child information group.

When necessary, all TLVs will be padded so that their lengths will always be a multiple of four octets. If padding is required, the TLV format in question will specify the formula for padding those octets.

All reserved fields and any padding fields must be set to zero by the originator and must be ignored upon reception.

Unless otherwise specified, all fields are unsigned integers. Multi-octet fields are transmitted in “network order” (big endian octet order), that is with the most significant octet occurring first in the octet stream.

5.14.1 Notation

Bit positions within an octet are specified by numbers 1 through 8, where 1 represents the least significant bit, and 8 represents the most significant bit of the octet. Bit positions within n-octet fields are specified by numbers 1 through 8*n, where 1 represents the least significant bit of the last octet, and 8*n represents the most significant bit of the first octet.

5.14.2 Information Group Tags

As described above, PNNI packets are constructed using information groups. Many of these information groups are defined in this specification. However, it is not possible to define all possible information groups. To provide for future extensibility, it is important that information groups be identified in such a way that systems which do not recognize them will process them properly. This will allow for the incremental addition of new features.

Other routing protocols have found that a viable technique to deal with the future growth of information groups is to tag them. For example, BGP and IDRP have a Mandatory vs. Optional tag, and a transitive vs. intransitive tag. While we cannot use exactly the same tags, we can use their experience.

In order to provide for consistent processing, all information groups have tags. These tags are only used for processing unrecognised information groups.

5.14.2.1 Mandatory Tag

The mandatory tag prevents systems which do not understand the information group from using the immediately containing information group, except where noted otherwise in this specification¹. For example if the unknown mandatory information group occurs immediately within a horizontal link information group, then the described link must not be used in route computation.

If a system receives a PTSE with a top level mandatory tagged information group that is otherwise unknown, it must accept the PTSE, check the checksum and sequence number in the normal manner, and acknowledge, store, and forward the PTSE as appropriate in the normal manner. However, the network ~~entity-entities~~ (node, reachable addresses, nodal spokes and bypasses or links¹) described by that PTSE must not be used for any route computation, nor included in DTLs which are created resulting from a route computation.

However, a node receiving a call request containing a specified DTL must follow the DTL as specified independent of whether any element contained in the DTL may have been described using unknown mandatory information groups, or whether any information groups containing the element were described using unknown mandatory information groups¹. The node receiving the call request must process the call request, and assume that the system which prepared the associated DTLs knew what it was doing (i.e., understood any mandatory information groups) and therefore was able to choose a correct DTL for the call. Similarly, if a higher level DTL specifies use of a specific link, which maps to a particular lower level uplink or uplinks, then a node selecting a corresponding lower level DTL must choose a corresponding lower level uplink in its DTL, regardless of any unknown mandatory information groups on the uplink. This is described in more detail in Section 6.

For purposes of PGL election, the nodal information of all reachable nodes in the peer group is considered, even when the nodal information PTSE or nodal information IG contains an unknown mandatory information group (see Section 5.10.1). Unknown mandatory information groups also have no effect on the connectivity calculation used for PGL election and summarization (see Sections 5.10.1.1.3 and 5.11.3).¹

For ~~phase 4~~PNNI 1.1 all information groups defined in this specification must be recognized.

5.14.2.2 Summarizing Tag

The PGL prepares summaries of the peer group information for use at the next level up. If some of the information contains unknown information groups, the PGL must decide what to do with the information. Note that this decision is independent of the Mandatory tag.

An unknown information group may be tagged to indicate that the PGL must not summarize the containing entity into the parent peer group. Internal links and nodes containing unknown non-summarizable information groups would not be considered in calculating the default node representation based on peer group transit characteristics. Reachability information containing unknown non-summarizable information groups would not be advertised from the higher level logical group node. Uplinks containing unknown non-summarizable information groups are ignored in forming higher layer uplinks and horizontal links. One effect of this rule is that if all the uplinks with a given aggregation token have unknown non-summarizable information groups, then the induced uplink or horizontal link will not be created.

If a system receives a PTSE with an unknown top level information group tagged as not summarizable, the other top level information groups in the PTSE must not be summarized.¹

5.14.2.3 Transitive Tag

Assuming that an item with an unknown information group may be summarized, there is still the question of what to do with the individual information group. If the information group is tagged non-transitive, then the information group must be removed prior to summarization. If it is tagged transitive, then the information group must be preserved (still tagged as transitive and summarizable) in the advertisements of the LGN representing the PGL's peer group¹.

With items which are exposed individually, such as a single outside link, preservation of a transitive information group is not a problem. With aggregated entities there is more question.¹

For top level information groups in PTSEs, the transitive tag must be ignored and treated as if it were set to non-transitive. The rules on mandatory non-transitive information groups apply to this case, even when the transitive tag is set (see Section 5.14.2.4).¹

When a PGL receives a nodal IG that contains an unknown information group tagged as summarizable and transitive, the unknown information group must be advertised by the LGN representing the PGL's peer group, contained in the LGN's nodal information group. If an information group is tagged as transitive, and is aggregated into an advertisement in the parent peer group, and the information group is not known by the peer group leader, then the resulting advertisement must contain the information group (still tagged as transitive and summarizable).¹ Note that this means that if a single node in a peer group has a summarizable transitive unknown ~~attribute metric~~, then that information group will be applied to the entire peer group.

When a PGL receives an internal or exterior reachable address IG that contains an unknown information group tagged as summarizable and transitive, the unknown information group must be advertised by the LGN representing the PGL's peer group, contained in the corresponding internal or exterior reachable address IG(s).¹ The presence of summarizable transitive unknown IGs affects how the LGN groups the summarizing prefixes into information groups (see Sections 5.8.1.3.1 and 5.8.1.3.2). In particular, a set of summarizing prefixes can be grouped into one IG only if all included unknown IGs apply to each of the summarizing prefix in the set. An unknown IG is said to apply to a summarizing prefix if it is associated with any of the prefixes that are summarized into the summarizing prefix.³

When a PGL receives a horizontal link or nodal state parameters IG that contains an unknown information group tagged as summarizable and transitive, the unknown information group must be advertised by the LGN representing the PGL's peer group, contained in at least one of its nodal state parameters IGs. For example, if the default node representation is used, then the unknown information group must be contained in the nodal state parameters IG specifying the radius. Alternatively, if the unknown information group applies only to nodal connectivity from one specific port, a specific exception nodal state parameters IG could be generated to represent the spoke to that port, with the unknown information group contained in the exception IG. Note that an information group contained in a horizontal link IG must not be tagged as transitive unless that type of information group is also defined to occur within nodal state parameters IGs.¹

When a PGL receives an uplink IG that contains an unknown information group tagged as summarizable and transitive (or contains a ULIA that contains an unknown information group tagged as summarizable and transitive), the unknown information group must be advertised by the LGN representing the PGL's peer group, contained in the corresponding uplink or horizontal link IG. Note that an information group contained in an uplink IG must not be tagged as transitive unless that type of information group is also defined to occur within horizontal link IGs.¹

If two or more advertisements which are being aggregated ~~both each~~ carry an information group of the same transitive type, but with different values, then the PGL ~~will must~~ preserve ~~both the~~¹ information groups, implying that the same information group may occur multiple times.

5.14.2.4 Mandatory Non-Transitive Information Groups

There is a slight complication involving information groups which are mandatory, but non-transitive. In this case the fact that the information group is mandatory implies that the associated node or link cannot be advertised at a higher level unless the mandatory information group is included. The fact that the information group is non-transitive implies that if the associated network entity is aggregated at a higher level, then the information group cannot be included in the summary entity advertisement.

The solution here is that a mandatory non-transitive information group attached to the advertisement of a network entity implies that the entity cannot be summarized for advertisement at higher levels. Thus, if an uplink is marked as mandatory and non-transitive, then that outside link cannot be aggregated with other links in the corresponding uplink advertisement. If a node or internal link within a peer group is marked with a mandatory non-transitive information group, then that node or internal link is not used for purposes of calculating the characteristics of the corresponding logical group node.

5.14.2.5 Examples

In order to strengthen the case for these information group tags, a few examples information groups that might be added later, and their tags, are given.

5.14.2.5.1 Advisory Metrics and Attributes

As the technology evolves, we may create new metrics, attributes, or service related characteristics. While these may be needed for some calls, clearly calls which do not need them may still use the links, even if the nodes have no understanding of these capabilities.

Thus, these would be Optional, Summarizable information groups. Whether or not such information groups are transitive probably depends on the details of their aggregation behavior, and so will vary from information group to information group.

5.14.2.5.2 Local Information Groups

A particular customer may persuade one or more providers of equipment to provide new information. Such information is probably ignorable, but because it is experimental it must not be summarized outside the domain of the experiment. The tagged elements are still usable externally. As such, these information groups will usually be Optional, Summarizable, Non-Transitive information groups.

On the other hand, one might have a special purpose link whose usage was limited to a certain class of user. In order to ensure that a sloppy peer group leader did not let the advertisement out, this link might have an information group identifying the class of permitted users. This advertisement would be Mandatory and Non-Summarizable.

5.14.2.5.3 User lists

We may at some time define information groups for carrying lists of which users are permitted or not permitted to use a resource (link or node). We would then define these information groups as Mandatory and Non-transitive. Making this a Non-Transitive information group would ensure that during deployment, the resources were made externally visible explicitly rather than through an aggregation method which would misrepresent the restriction.

5.14.2.5.4 Security Labels

Without delving into all the aspects of security, one can envision at some future time creating a security label. These would probably be Mandatory, Summarizable, Transitive information groups.

5.14.2.6 Information Group Tag Bit Definitions

All PNNI types are encoded in 16 bit fields. The most significant 4 bits of this field are reserved for the information group tags. Specifically:

Mandat	D-Sum	Trans	Reserv
--------	-------	-------	--------

are the four most significant bits.

- Mandat = The Mandatory bit (bit 16). This bit is set to 1 for information groups where, if this information group is not understood the contain IG or PTSE must not be used in path calculation.
- D-Sum = the Don't Summarize bit (bit 15). This bit is set to 1 for information groups where, if this information group is not understood the containing IG or PTSE must not be summarized into the containing peer group.
- Trans = the Transitive bit (bit 14). This bit is set to 1 if this information group is to be preserved when the containing IG or PTSE is aggregated and the information group is not understood by the peer group leader.
- Reserv = a reserved bit (bit 13). As with all reserved fields, this must be 0 on transmission and ignored on reception.

All PNNI 1.0 information groups shall be originated with their information group tags set to optional, summarizable, non-transitive, with ~~one-two~~ exceptions; the Transit network ID information group shall have information group tag values optional, summarizable, transitive and the system capabilities IG may have any combination of IG tags¹. The reason for choosing these default values is that most of the currently defined information groups are self-contained, in that loss of the information does not change the meaning of parent or sibling information groups. So, although the unrecognized information must be dropped since it is not understood how to summarize it, the containing information group can be summarized.

5.14.3 Information Group Summary

Table 5-18: Information Group Summary³

Type	IG Name	Contains IGs one level down
32	Aggregation token	System capabilities (640) , Security (641)
33	Nodal hierarchy list	System capabilities (640) , Security (641)
34	Uplink information attribute	Outgoing resource availability (128), System capabilities (640) , Security (641)
35	LGN horizontal link extension	System capabilities (640) , Security (641)
36	Outside nodal hierarchy list (Note 3)	System capabilities (640) , Security (641)
64	PTSE	Nodal state parameters (96), Nodal information group (97), Internal reachable ATM addresses (224), Exterior reachable ATM addressees (256), Horizontal links (288), Uplinks (289), System capabilities (640) , Security (641) , PAR service (768)
96	Nodal state parameters	Outgoing resource availability (128), System capabilities (640) , Security (641)
97	Nodal information group (Note 1)	Next higher level binding information (192), Outside nodal hierarchy list (36) , System capabilities (640) , Security (641)
128	Outgoing resource availability (Notes 4, 6)	Optional GCAC parameters (160), Optional BeCR parameter (161) , AccBCT parameter (162) , System capabilities (640) , Security (641)
129	Incoming resource availability (Notes 4, 6)	Optional GCAC parameters (160), Optional BeCR parameter (161) , AccBCT parameter (162) , System capabilities (640) , Security (641)
160	Optional GCAC parameters	System capabilities (640) , Security (641)
161	Optional BeCR parameter (Note 5)	System capabilities (640) , Security (641)
162	AccBCT parameter (Note 7)	System capabilities (640) , Security (641)
192	Next higher level binding information	System capabilities (640) , Security (641)
224	Internal reachable ATM addresses	Outgoing resource availability (128), Incoming resource availability (129), System capabilities (640) , Security (641)
256	Exterior reachable ATM addresses	Outgoing resource availability (128), Incoming resource availability (129), Transit network ID (304), System capabilities (640) , Security (641)
288	Horizontal links	Outgoing resource availability (128), System capabilities (640) , Security (641)
289	Uplinks	Uplink information attribute (34), Outgoing resource availability (128), System capabilities (640) , Security (641)
304	Transit network ID	System capabilities (640) , Security (641)
384	Nodal PTSE ack	System capabilities (640) , Security (641)
512	Nodal PTSE summaries	System capabilities (640) , Security (641)
513	Requested PTSE header	System capabilities (640) , Security (641)
640	System capabilities	(Note 9)

641	Security (Note 8)	Note: If marked as scope = higher level, this IG may not contain any other IGs one level down. If marked as scope = included IGs, this IG may contain any IGs one level down that would be contained in the IG one level up or in the packet at the same position occupied by this Security IG.
768	PAR service (Note 2)	System capabilities (640), Security (641), PAR VPN ID (776), PAR IPv4 service definition (784)
776	PAR VPN ID (Note 2)	System capabilities (640), Security (641), PAR IPv4 service definition (784)
784	PAR IPv4 service definition (Note 2)	System capabilities (640), Security (641), PAR IPv4 OSPF service definition (800), PAR IPv4 MOSPF service definition (801), PAR IPv4 BGP4 service definition (802), PAR IPv4 DNS service definition (803), PAR IPv4 PIM-SM service definition (804)
800	PAR IPv4 OSPF service definition (Note 2)	System capabilities (640), Security (641)
801	PAR IPv4 MOSPF service definition (Note 2)	System capabilities (640), Security (641)
802	PAR IPv4 BGP4 service definition (Note 2)	System capabilities (640), Security (641)
803	PAR IPv4 DNS service definition (Note 2)	System capabilities (640), Security (641)
804	PAR IPv4 PIM-SM service definition (Note 2)	System capabilities (640), Security (641)

[Note 1 - Modified in specification \[8\].](#)

[Note 2 - Defined in specification \[9\].](#)

[Note 3 - Defined in specification \[15\].](#)

[Note 4 - Modified in specification \[20\].](#)

[Note 5 - Defined in specification \[20\].](#)

[Note 6 - Modified in specification \[23\].](#)

[Note 7 - Defined in specification \[23\].](#)

[Note 8 - Defined in specification \[24\].](#)

[Note 9 - The contents of this IG are defined by the owner of the OUI, i.e. they are not defined by the ATM Forum.](#)

Table 5-18: Information Group Summary continued³

Type	IG Name	Contained in IGs one level up	Contained in packets
32	Aggregation token		Hello (1)
33	Nodal hierarchy list		Hello (1)
34	Uplink information attribute	Uplinks (289)	Hello (1)
35	LGN horizontal link extension		Hello (1) for LGN horizontal Hello
36	Outside nodal hierarchy list	Nodal information group (97)	PTSP (2)
64	PTSE		PTSP (2)
96	Nodal state parameters	PTSE — restricted IG	PTSP (2)
97	Nodal information group	PTSE — restricted IG	PTSP (2)
128	Outgoing resource availability	Uplink information attribute (34), Nodal state parameters (96), Internal Reachable ATM Address (224), Exterior reachable ATM addresses (256), Horizontal links (288), uplinks (289)	Hello (1), PTSP (2)
129	Incoming resource availability	Internal Reachable ATM Address (224), Exterior reachable ATM addresses (256)	PTSP (2)
160	Optional GCAC parameters	Outgoing resource availability (128), Incoming resource availability (129)	Hello (1), PTSP (2)
161	Optional BeCR parameter	Outgoing resource availability (128), Incoming resource availability (129)	Hello (1), PTSP (2)
162	AccBCT parameter	Outgoing resource availability (128), Incoming resource availability (129)	Hello (1), PTSP (2)
192	Next higher level binding information	Nodal information group (97)	PTSP (2)
224	Internal reachable ATM addresses	PTSE — restricted IG	PTSP (2)
256	Exterior reachable ATM addresses	PTSE — restricted IG	PTSP (2)
288	Horizontal links	PTSE — restricted IG	PTSP (2)
289	Uplinks	PTSE — restricted IG	PTSP (2)
304	Transit network ID	Exterior reachable ATM addresses (256)	PTSP (2)
384	Nodal PTSE ack		PTSE Ack (3)
512	Nodal PTSE summaries		DBSummary (4)
513	Requested PTSE header		PTSE Request (5)
640	System capabilities	PTSE, all IGs	all packets
641	Security	all IGs	all packets
768	PAR service	PTSE — restricted IG	PTSP (2)
776	PAR VPN ID	PAR service (768)	PTSP (2)
784	PAR IPv4 service definition	PAR VPN ID (776), PAR service (768)	PTSP (2)
800	PAR IPv4 OSPF service definition	PAR IPv4 service definition (784)	PTSP (2)
801	PAR IPv4 MOSPF service definition	PAR IPv4 service definition (784)	PTSP (2)
802	PAR IPv4 BGP4 service definition	PAR IPv4 service definition (784)	PTSP (2)
803	PAR IPv4 DNS service definition	PAR IPv4 service definition (784)	PTSP (2)
804	PAR IPv4 PIM-SM service definition	PAR IPv4 service definition (784)	PTSP (2)

Table 5-19: Information Groups in PNNI Packets³

Type	Packet Name	Contains Igs
1	Hello	Aggregation token (32), Nodal hierarchy list (33), Uplink information attribute (34), LGN horizontal link extension (35), Outgoing resource availability (128), Optional GCAC parameters (160), Optional BeCR parameter (161) , AccBCT parameter (162) , System capabilities (640), Security (641)
2	PTSP	PTSE (64), Outside nodal hierarchy list (36) , Nodal state parameters (96), Nodal information group (97), Outgoing resource availability (128), Incoming resource availability (129), Next higher level binding (192), Optional GCAC parameters (160), Optional BeCR parameter (161) , AccBCT parameter (162) , Internal reachable ATM addresses (224), Exterior reachable ATM addresses (256), Horizontal links (288), Uplinks (289), Transit network ID (304) , System capabilities (640), Security (641) , PAR service (768) , PAR VPN ID (776) , PAR IPv4 service definition (784) , PAR IPv4 OSPF service definition (800) , PAR IPv4 MOSPF service definition (801) , PAR IPv4 BGP4 service definition (802) , PAR IPv4 DNS service definition (803) , PAR IPv4 PIM-SM service definition (804)
3	PTSE ACK	Nodal PTSE Ack (384) , System capabilities (640), Security (641)
4	DBSummary	Nodal PTSE summaries (512) , System capabilities (640), Security (641)
5	PTSE Request	Requested PTSE header (513) , System capabilities (640), Security (641)

5.14.4 PNNI Packet Header

All PNNI routing packets begin with a common PNNI packet header, shown in the following table.

Table 5-20: The PNNI Packet Header

Offset	Size (Octets)	Name	Function/Description
0	2	Packet Type	See Table 5-21 PNNI Packet Types.
2	2	Packet length	
4	1	Protocol version	Specifies the version according to which this packet was formatted. This specification defines version one of the PNNI routing protocol packet formats.
5	1	Newest version supported	The newest version supported and oldest version supported fields are included in order for nodes to negotiate the most recent protocol version that can be understood by both nodes exchanging a particular type of packet.
6	1	Oldest version supported	See Above.
7	1	<i>Reserved</i>	

Table 5-21: PNNI Packet Types

Packet Type	Packet Name
1	Hello
2	PTSP
3	PTSE Acknowledgement
4	Database Summary
5	PTSE Request

5.14.5 The Resource Availability Information Group

Before proceeding with specification of the various types of PNNI packets, specification is first given of two TLV information groups that occur at several places in the PNNI packet formats. These are the outgoing and incoming resource availability information groups, which are used to attach values of routing metrics and attributes to nodes, links, and reachable addresses. For nodes, only the outgoing resource availability information group is used. For links and reachable addresses, the outgoing resource availability information group (type = 128) is used to specify routing metrics and attributes from this node to the neighbor node or reachable address. The incoming resource availability information group (type = 129) is used to specify routing metrics and attributes from the neighbor node or reachable address to this node. Except for the initial type code, the two resource availability information groups are identical.

Each resource availability information group applies to a set of service categories, which are described using a bit-mask encoding. This encoding allows for one information group to be used to specify routing metrics and attributes for several service categories, when the values of all shared routing metrics and attributes are identical for all specified service categories. Metrics or attributes that are not applicable to certain service categories must be ignored when considered for use with those service categories. In order to advertise different routing metrics and attributes for different sets of service categories, separate resource availability information groups must be used. A resource must not be used to support a service category unless the category is specified in the bit-mask of a Resource Availability Information Group advertised for the resource.

Table 5-22: The Resource Availability Information Group

Offset	Size (Octets)	Name	Function/Description
0	2	Type	Type = 128 for outgoing resource availability information Type = 129 for incoming resource availability information
2	2	Length	
4	2	RAIG Flags	For Bit definitions see Table 5-23 RAIG Flags.
6	2	<i>Reserved</i>	
8	4	Administrative Weight	default value = DefaultAdminWeight, additive
12	4	Maximum Cell Rate	Units : cells/second <u>Note: if this attribute is not used, its value shall be set to 0xFFFFFFFF on transmission and ignored on reception.</u> ³
16	4	Available Cell Rate	Units : cells/second <u>Note: if this attribute is not used, its value shall be set to 0xFFFFFFFF on transmission and ignored on reception.</u> ³
20	4	Cell Transfer Delay	Units : microseconds <u>Note: if this metric is not used, its value shall be set to 0xFFFFFFFF on transmission and ignored on reception.</u> ³
24	4	Cell Delay Variation	Units : microseconds <u>Note: if this metric is not used, its value shall be set to 0xFFFFFFFF on transmission and ignored on reception.</u> ³
28	2	Cell Loss Ratio (CLP=0)	Encoded as the negative logarithm of the value, i.e., the value n in a message indicates a CLR of 10 ⁻ⁿ <u>Note: if this attribute is not used, its value shall be set to 0xFFFF on transmission and ignored on reception.</u> ³
30	2	Cell Loss Ratio (CLP=0+1)	Encoded as the negative logarithm of the value, i.e., the value n in a message indicates a CLR of 10 ⁻ⁿ <u>Note: if this attribute is not used, its value shall be set to 0xFFFF on transmission and ignored on reception.</u> ³
Optional GCAC related information:			
32	2	Type	Type = 160 (optional GCAC parameters)
34	2	Length	
36	4	Cell Rate Margin	Units : cells/seconds
40	4	Variance Factor	units of 2 ⁻⁸ . Note : the value of 0xFFFFFFFF for Variance Factor is used to indicate infinity

Table 5-23: RAIG Flags

Bit ID:	Bit 16 (MSB)	Bit 15	Bit 14	Bit 13	Bit 12	Bits 11..2	Bit 1 (LSB)
Meaning:	CBR	rt-VBR	nrt-VBR	ABR	UBR	<i>Reserved</i>	GCAC CLP Attribute

5.14.6 Uplink Information Attribute

Uplink advertisements made by border nodes and PGLs as well as Hellos sent on outside links, must include an Uplink Information Attribute (ULIA). The ULIA is basically a TLV encoded container or wrapper used to enclose and identify other information groups that apply to the reverse direction on uplinks.

A Resource Availability Information Group must be included for each service category supported. Optionally any other information group needed to describe any other aspect of the uplink, will also be included here.

Table 5-24: The Uplink Information Attribute

Offset	Size (Octets)	Name	Function/Description
0	2	Type	Type = 34 (uplink information attribute)
2	2	Length	
4	4	Sequence number	
<ul style="list-style-type: none"> All outgoing Resource Availability Information Groups (type = 128) to describe the reverse direction of the uplink. Any additional optional IGs needed to describe the reverse direction of the uplink. 			

5.14.7 Transit Network ID

Transit network identification information is needed in PNNI. This information group is used to carry such information.

This information group may appear in the exterior reachable address IG.

Table 5-25: Transit Network ID

Offset	Size (Octets)	Name	Function/Description
0	2	Type	Type = 304 (transit network ID)
2	2	Length	
4	2	Length of TNS	Number of octets in the Network Identification string + Network Identification Data.
6	1	Network identification data	See Table 5-26.
7	<i>N</i>	Network identification	IRA characters. 1 octet per character. See ITU-T T.50 (1992) International Reference Alphabet (IRA) (Formerly International Alphabet No. 5 or IA5).
7+ <i>N</i>		Padding	0-3 octets Padding is calculated using the formula: $(4 - [(3 + N) \text{ modulus } 4]) \text{ modulus } 4$

Table 5-26: Network Identification Data

Note: The values of the Network identification data fields are as specified by ITU.

Bit ID:	Bit 8 (MSB)	Bits 7..5	Bits 4..1
Description:	<i>Reserved</i>	Type of network identification	Network identification plan

5.14.8 PNNI Hellos

PNNI Hellos are transmitted by each node over (a) all physical links to immediate neighbor nodes, (b) all virtual path connections for which this node is an endpoint, and (c) all SVCCs established for the purpose of exchanging PNNI routing information for which this node is an endpoint. The purpose of exchanging Hellos between neighbor nodes is in order to establish the state of the link(s) between them.

Table 5-27: The PNNI Hello

Offset	Size (Octets)	Name	Function/Description
0	8	PNNI Header	A PNNI packet header structure with Packet type = 1 (Hello). See Table 5-20.
8	2	Flags	<i>Reserved</i>
10	22	Node ID	Node ID of the originating node.
32	20	ATM End System Address	A system which implements PNNI routing must have a unique ATM End System Address for each node which it represents, and must be able to accept calls to that ATM End System Address (for example, this may be used for network management). For split systems and for peer group leaders, up to 256 unique ATM End System Addresses may be realized by using the selector octet to differentiate between the ATM End System Addresses corresponding to different nodes.
52	14	Peer Group ID	Peer group ID of the originating node.
66	22	Remote node ID	set based on value of node ID in received Hellos on same link, set to all zeros if not yet known
88	4	Port ID	<ul style="list-style-type: none"> • A valid port ID is not allowed to have the value zero. • For cases where either one or both ends are acting as peer group leaders (Hellos are being exchanged over SVCCs rather than over VCI 18), the port ID takes the value 0xFFFFFFFF.
92	4	Remote Port ID	Set based on value of port ID in received Hellos on same link. Set to zero if not yet known.
96	2	Hello Interval	Hello Interval indicates how frequently the Hello packet is sent. If no Hello is received within a time period of (InactivityFactor times Hello Interval) then the link is assumed to have failed.
98	2	<i>Reserved</i>	

Hellos sent over links destined for outside of this node's peer group include the **Aggregation Token**, **Nodal Hierarchy List**, and **Uplink Information Attribute** information groups (see Section 5.6.2.2). The **Uplink Information Attribute** is described in Table 5-24.

Hellos sent between LGNs as part of the LGN Horizontal Link Hello Protocol (see Section 5.6.3.2) include the **LGN Horizontal Link Extension** information group.

5.14.8.1 The Aggregation Token IG

The Aggregation Token is used to control how outside links are aggregated at higher levels of the hierarchy. See Section 5.10.3.1 for a complete description of link aggregation.

Table 5-28: The Aggregation Token IG

Offset	Size (Octets)	Name	Function/Description
0	2	Type	Type = 32 (aggregation token)
2	2	Length	
4	4	Aggregation token	

5.14.8.2 The Nodal Hierarchy List IG

The nodal hierarchy list is included in order to allow lower-level neighbor nodes to determine their lowest-level common peer group, and also to exchange the node ID and ATM End System Addresses of the corresponding higher-level neighbor nodes within the common peer group. The details of operation in synchronizing the behavior between neighboring peer groups and achieving correct operation of higher level routing are described in Section 5.6.

Table 5-29: The Nodal Hierarchy List

Offset	Size (Octets)	Name	Function/Description
0	2	Type	Type = 33 (nodal hierarchy list)
2	2	Length	
4	4	Sequence number	
8	2	<i>Reserved</i>	
10	2	Level Count	The number of known higher level peer groups.
<ul style="list-style-type: none"> Repeat the following structure Level Count times, beginning with the parent level and proceeding in order until the node's identity at the highest known level has been listed: 			
	22	Next higher level logical node ID	
	20	Next higher level ATM End System Address	ATM End System Address of the next higher level logical node.
	14	Next higher level peer group ID	Next higher level logical node's peer group ID

5.14.8.3 The LGN Horizontal Link Extension IG

The following TLV is known as the LGN Horizontal Link Extension. It carries the state information about all of the horizontal links between two Logical Group Nodes. It is carried as an additional TLV in the same message which is used to maintain the state of the SVCC between the LGNs.

Table 5-30: The LGN Horizontal Link Extension IG

Offset	Size (Octets)	Name	Function/Description
0	2	Type	Type = 35 (LGN Horizontal Link Extension)
2	2	Length	
4	2	<i>Reserved</i>	
6	2	HLink Count	The number of horizontal links being described.
Repeat the following structure HlinkCount times:			
	4	Aggregation token	
	4	Local LGN port	
	4	Remote LGN port	

5.14.9 PNNI Topology State Packets (PTSP)

PNNI Topology State Packets (PTSPs) are used to distribute information throughout a peer group. All PTSPs include the PTSP header described in the following table.

Table 5-31: The PTSP Header

Offset	Size (Octets)	Name	Function/Description
0	8	PNNI Header	A PNNI packet header structure with Packet type = 2 (PNNI Topology State Packet). See Table 5-20.
8	22	Originating Node ID	Identifies the node that originated the PTSE(s) in this PTSP.
30	14	Originating Node's peer group ID	

Each PTSP consists of multiple PNNI Topology State Elements (PTSEs), all from the same originating node. Each PTSE includes its own checksum and authentication field (null in PNNI Phase 1.0), allowing for PTSEs from the same originating node to be bundled in different combinations upon origination and as they are propagated across a peer group. A PTSE provides the information unit that is used for purposes of retransmission, application of sequence numbers and checksums, and authentication.

Each PTSE includes the PTSE header described in the following table:

Table 5-32: The PTSE Header

Offset	Size (Octets)	Name	Function/Description
0	2	Type	Type = 64 (PTSE)
2	2	Length	
4	2	PTSEType	PTSE Type must be one of the type codes of a restricted IG or NoRestrictedIG (type=0). In this PTSE, that particular restricted IG may appear, and also any unrestricted IGs. Restricted IGs other than the one mentioned are not allowed. If the type is NoRestrictedIG then no restricted IGs are allowed. Indicates which restricted information groups are allowed to appear inside of the PTSE. Only those restricted information groups with a matching TLV type may be included. ¹ Note that this is not aiming to influence the types of TLVs embedded inside of the restricted information groups. Only the 'top-level' restricted information groups in the PTSE have to conform to this rule.
6	2	<i>Reserved</i>	
8	4	PTSE Identifier	Identifies one of multiple different PTSEs from a node. PTSEs with the PTSE Identifier value of '1' are reserved for the purpose of distributing the nodal information group. Its PTSEType field has the value matching the nodal information group type value.
12	4	PTSE Sequence Number	
16	2	PTSE Checksum	Note: The PTSE checksum includes the logical node ID and the Originating Node's Peer Group ID from the PTSP header as well as the entire contents of the PTSE (including the PTSE header), and excludes the PTSE Remaining Lifetime. The checksum algorithm used for

			computation of the PTSE checksum is described in Section 5.8.2.2.2.
18	2	PTSE Remaining Lifetime	

In addition to restricted information groups, any number of unrestricted information groups, described below, can appear in all PTSE types.

5.14.9.1 Restricted Information Groups

5.14.9.1.1 The Nodal state parameters IG

Nodal state parameter information groups are used to advertise elements of this node's complex node representation. All metrics and attributes for each input-output port pair must be included in the same nodal state parameters information group. This information group can appear multiple times and in multiple different PTSEs, with different pairs of input and output ports each time.

Table 5-33: The Nodal State Parameters IG

Offset	Size (Octets)	Name	Function/Description
0	2	Type	Type = 96 (nodal state parameters)
2	2	Length	
4	2	Flags	See Table 5-34.
6	2	<i>Reserved</i>	
8	4	Input Port ID	
12	4	Output Port ID	
Repeat for each (set of) service category(ies):			
Outgoing resource availability information group (type = 128)			

Table 5-34: Flags

Bit ID:	bit 16 (MSB)	bits 15..1
Bit Name:	VP Capability Flag	<i>Reserved</i>

The VP Capability Flag is set to one if the corresponding entity is capable of carrying VPCs. If VPCs are not supported, then the VP Capability Flag is set to zero. For example, if a horizontal link or uplink is made up entirely of VPCs or aggregate VPCs, with no components that are entire physical links, then it will be incapable of carrying VPCs within it and the VP Capability Flag must be set to zero.

5.14.9.1.2 The Nodal Information Group

The nodal information group is used to convey general information about the node such as its peer group ID and its ATM End System Address, and also for all PGL election information. This information group appears once among all PTSEs advertised by this node.

Table 5-35: The Nodal IG

Offset	Size (Octets)	Name	Function/Description
0	2	Type	Type = 97 (nodal information group)
2	2	Length	
4	20	ATM Address	ATM End System Address of originating node.
24	1	Leadership priority	The value of 0 is reserved for a node which is either unwilling or unable to become peer group leader.
25	1	Nodal Flags	See Table 5-36.
26	22	Preferred peer group leader node ID	
Next higher level binding information: (sent by peer group leaders if there is a higher level):			
48	2	Type	Type = 192 (next higher level binding information)
50	2	Length	
52	22	Parent logical group node ID	Parent logical group node ID (in parent peer group)
74	20	Parent LGN's ATM End System Address	
94	14	Parent Peer Group ID	
108	22	Node ID of PGL of parent peer group	NULL if unknown <i>NULL is coded as all zero's.!</i>
130	2	<i>Reserved</i>	

Table 5-36: Nodal Flags

Bit ID:	bit 8 (MSB)	bit 7	bit 6	bit 5	bit 4	bits 3..1
Bit Name:	"I am Leader" bit	"Restricted Transit" bit	"Nodal Representation" bit	"Restricted Branching" bit	Non-transit for PGL election	Reserved
Description:	value 0: "I am not PGL" value 1: "I am PGL"	value 0: "I am a transit node" value 1: "I am a restricted transit node"	value 0: "simple node representation" value 1: "complex node representation"	value 0: "can support additional branch points" value 1: "cannot support additional branch points"	value 0: "normal operation" value 1: "no connectivity through this node for PGL election"	

5.14.9.1.3 The Internal Reachable ATM Addresses Information Group

The internal reachable ATM addresses information group is used to advertise the addresses of directly attached ATM endpoints. This information group can appear multiple times and in multiple different PTSEs, listing different sets of internal reachable ATM addresses each time.

Table 5-37: The Internal Reachable ATM Address IG

Offset	Size (Octets)	Name	Function/Description
0	2	Type	Type = 224 (internal reachable ATM addresses)
2	2	Length	
4	2	Flags	See Table 5-34.
6	2	<i>Reserved</i>	
8	4	Port ID	
12	1	Scope of advertisement	A PNNI routing level. The scope of advertisement applies to all address prefixes included in the information group, whether they are individual or group addresses or a mixture of the two.
13	1	Address information length	<i>ail</i> , in octets
14	2	Address information count	<i>aic</i>
Repeat (<i>aic</i>) times:			
	1	prefix length	units: bits
	<i>ail-1</i>	reachable address prefix	padded with $[8*(ail-1) - \text{prefix length}]$ bits of zeros at the right most tail (lowest bits) of the last octet(s) of the Reachable Address Prefix
		Padding	0-3 octets. Note : The size of the Padding field is calculated using the following formula: $(4 - ((aic * ail) \text{ modulus } 4)) \text{ modulus } 4$
Optional TLV groups for resource availability information, repeat for each (set of) service category(ies):			
<ul style="list-style-type: none"> Outgoing resource availability information group (type = 128) Incoming resource availability information group (type = 129) If present, the resource availability information groups apply to all present reachable address prefixes, and are to be combined directly with PNNI internal service category parameters.			

5.14.9.1.4 The Exterior Reachable ATM addresses Information Group

The exterior reachable ATM addresses information group is used to advertise the addresses of ATM endpoints that can be reached by passing through exterior networks, that do not participate in PNNI routing. This information group can appear multiple times and in multiple different PTSEs, listing different sets of exterior reachable ATM addresses each time. All metrics and attributes associated with each exterior reachable ATM address must be included in the same exterior reachable ATM address information group in which the reachable address appears.

Table 5-38: The Exterior Reachable ATM Address IG

Offset	Size (Octets)	Name	Function/Description
0	2	Type	Type = 256 (exterior reachable ATM addresses)
2	2	Length	
4	2	Flags	See Table 5-34.
6	2	<i>Reserved</i>	
8	4	Port ID	
12	1	Scope of advertisement	A PNNI routing level. The scope of advertisement applies to all transit networks. It also applies to all address prefixes included in the information group, whether they are individual or group addresses or a mixture of the two.
13	1	Address information length	<i>ail</i> , in octets
14	2	Address information count	<i>aic</i>
Repeat (<i>aic</i>) times:			
	1	prefix length	units : bits
	<i>ail-1</i>	reachable address prefix	padded with $[8*(ail-1) - \text{prefix length}]$ bits of zeros at the right most tail (lowest bits) of the last octet(s) of the Reachable Address Prefix
	0..3	Padding	0-3 octets. Note : The size of the Padding field is calculated using the following formula: $(4 - ((aic * ail) \text{ modulus } 4)) \text{ modulus } 4$
<ul style="list-style-type: none"> • Optional TLV groups for resource availability information, repeat for each (set of) service category(ies). If present, the resource availability information groups apply to all present reachable address prefixes, and are to be combined directly with PNNI internal service category parameters: <ul style="list-style-type: none"> • Outgoing resource availability information group (type = 128) • Incoming resource availability information group (type = 129) • Additional optional TLV groups <ul style="list-style-type: none"> • Transit network ID (type = 304). 			

5.14.9.1.5 The Horizontal Links Information Group

The horizontal links information group is used to advertise links to other nodes within the same peer group. This information group can appear multiple times and in multiple different PTSEs, listing different horizontal links each time. All metrics and attributes associated with each horizontal link must be included in the same horizontal link information group.

Table 5-39: The Horizontal Links IG

Offset	Size (Octets)	Name	Function/Description
0	2	Type	Type = 288 (horizontal links)
2	2	Length	
4	2	Flags	See Table 5-34.
6	22	Remote Node ID	The combination of local node ID and port ID unambiguously identify the link. The combination of remote node ID and remote port ID unambiguously identify the reverse link—this is needed to allow metrics in both directions to be related.
28	4	Remote Port ID	See above
32	4	Local Port ID	
36	4	Aggregation Token	

- Repeat for each (set of) service category(ies):
 - Outgoing resource availability information group (type = 128)

5.14.9.1.6 The Uplinks Information Group

The uplinks information group is used to advertise links to nodes that are outside of this peer group. This information group can appear multiple times and in multiple different PTSEs, listing different uplinks each time. All metrics and attributes associated with each uplink must be included in the same uplink information group.

Table 5-40: The Uplinks IG

Offset	Size (Octets)	Name	Function/Description
0	2	Type	Type = 289 (uplinks)
2	2	Length	
4	2	Flags	See Table 5-34.
6	2	<i>Reserved</i>	
8	22	Remote Higher Level Node ID	
30	14	Common Peer Group ID	
44	4	Local Port ID	
48	4	Aggregation Token	
52	20	ATM End System Address of Upnode	

- Repeat for each (set of) service category(ies):
 - Outgoing resource availability information group (type = 128)
- Uplink Information Attribute (type = 34)

5.14.9.2 Unrestricted Information Groups

The Systems Capabilities information group is the only unrestricted information group ~~used—defined in PNNI 1.1Phase 11.0. The Security information group defined in [24] is another example of an unrestricted information group.~~ Other unrestricted information groups may be defined in later ATM Forum specifications, versions of PNNI. Those foreseen are for authentication and access control.³

5.14.9.3 Unknown Information Groups

~~Unknown~~ An unknown information group ~~is~~ ~~are~~ those which appear in a PTSE of a certain type, but which do not match the type indicated and are not known to be unrestricted TLVs is an information group with a type that is not defined to occur within its containing information group. As specified in Section 5.14.2, unknown information groups are to be processed according to the specified information group tags.¹

Such information groups might be encountered when PTSEs issued by a node running a newer version of PNNI are received by a node running an older version.

As a special case, in the system capabilities information group the IEEE OUI is considered to be logically included as part of the IG type (i.e., the system capabilities information group is treated as unknown whenever the IEEE OUI value in the information group is unknown).¹

5.14.9.4 Processing PTSEs Violating Restrictions

Due to the described restrictions in the content of PTSEs, it cannot be excluded that certain PTSEs will be flooded which violate these rules ~~The possible error cases and the actions to be taken are~~¹:

- ~~1) If a PTSE includes a restricted information group whose type does not match the PTSEType, the information contained in such a group is ignored for the sake of route computation.~~
- ~~2) Unknown information groups are treated like unrestricted information groups. They are processed according to the specified information group tags.~~
- ~~3) If a mandatory restricted information group is missing in a PTSE (an example would be an empty PTSE with type equal to "nodal information" and PTSE Identifier = 1), the PTSE must be ignored during route computation.~~
- ~~4) If a PTSE with an unknown PTSEType is received, all restricted information groups inside are treated according to rules 1) and 2).~~¹

In order to describe the actions taken in certain error cases, the concept of state-significant computations is introduced. A TLV or IG should not only be ignored for the sake of path computation but also ignored for State-significant computations are those computations that involve any any other¹ kind of processing on the topology database mirroring into the content of other PTSEs. Those kinds of computation are called state-significant computations because they influence the internal state of the protocol and are as specified today:

- i) link aggregation
- ii) uplink generation
- iii) computation of complex node representation of the peer group
- iv) peer group leader election except counting the vote for the election if present
- v) computation of hierarchy to be advertised in outside hellos
- vi) reachability computation

Path computation is not considered a state-significant computation due to the fact that if two nodes compute different routes from the same set of information, it may adversely affect the throughput of the network and call rejection rates but does not prevent the protocol state machines themselves from operating correctly. Therefore, path computation is free to choose different strategies when dealing with the cases described below varying from one implementation to another although it is recommended that the rules specified are used. Information which is ignored according to the following sections must be re-evaluated when the condition which caused it to be ignored changed.

The possible error cases, with regard to processing of restricted and unrestricted IGs received within PTSEs, and the actions to be taken are:

- 1) If a PTSE includes a restricted information group whose type does not match the PTSEType, the information contained in such a group is ignored for the sake of state-significant computations.
- 2) Unknown information groups are treated like unrestricted information groups (i.e., it is assumed that they are allowed to appear in PTSEs of any PTSEType). They are processed according to the specified information group tags.
- 3) If a PTSE with an unknown PTSEType is received, all information groups inside are treated according to rules 1) and 2).¹

5.14.9.5 PTSE Error Scenarios

The TLV formatting supported in the PTSEs does not syntactically prevent ambiguities in packet semantics such as:

- a) ~~Although the type of an IG is defined to occur within its containing IG, for other reasons the IG is not supposed to appear, but a TLV is supposed not to appear,~~¹ appears at least once
- b) An IG TLV is supposed to appear exactly once inside an embedding TLV~~IG, but~~ appears multiple times
- c) An IG TLV is supposed to appear at least once, ~~but~~ does not appear at all
- ~~d) a TLV of this type is not supposed to appear embedded in the embedding type~~¹
- e) ~~d)~~ the same TLV-IG appears multiple times in different PTSEs (PTSEs with different IDs)

~~Note that type values are only understood within the context of the containing information group, as specified in Section 5.14. Specifically, an IG with a type that is not defined to occur within its containing IG shall be treated as unknown, and shall be processed according to the values of the information group tags encoded in its type field. Note that there is a difference between this case and a) above, where the IG is understood but presence of the IG is not consistent with the values of other variables advertised by that node.~~¹

~~Case d) is treated uniformly. An unexpected TLV appearing inside of embedding TLV (e.g. nodal info TLV appearing inside of a horizontal link TLV) is treated according to Section 5.14.9.4. (where a RIG appears inside a PTSE indicating a different type).~~¹

~~Note: There is a subtle difference between a) and d) and between a) and the unknown TLV case (the latter is handled by attribute tags).~~¹

5.14.9.5.1 Nodal Info Group in Nodal Info PTSE

- a) not applicable
- b) if a nodal info TLV-IG appears multiple times in the designated PTSE, two implementations interpreting different of those TLVs-IGs as valid could lead to scenarios where PGL election does not converge. The solution ~~proposed~~ is to only consider the first appearing nodal info TLV-IG as valid and significant for state-significant computation purposes and ignore all following IGs¹.
- c) if a nodal info TLV-IG does not appear in the designated PTSE at all, ~~it is proposed that~~ the PTSE and all further PTSEs issued by this node ~~should shall~~ be ignored for the state-significant computations ~~except vi). So a node with an invalid nodal info can be used to compute reachability to other nodes in the network for the sake of e.g. peer group leader election but its PTSEs like e.g. horizontal links cannot be used for the sake of path computation.~~¹
- d) n/a.
- e) is not possible due to the fact that this IG can appear only in a PTSE with ID 1, otherwise it is ignored.

5.14.9.5.2 Next higher Level Binding TLV-IG in Nodal Info IG-TLV

- a) if such an IG-TLV appears once or multiple times inside of a nodal info TLV-IG with cleared 'I am leader'-Bit, such a TLV-IG must be ignored.

The following cases only apply to IG-TLVs where the 'I am leader'-Bit is set and additionally the node has been determined as peer group leader:

- b) if the binding appears multiple times, only the first thereof must be used for state-significant computation and all following ignored.
- c) ~~if no next higher level binding IG appears, then this node behaves as if the 'I am leader' bit is not set (i.e., this node's ancestry is unknown at levels higher than that of the advertising node). Specifically, the nodal hierarchy list advertised by this node in Hellos to outside neighbors cannot include any information about the advertising node's parent node. This node also cannot originate calls on uplinks to upnodes at levels higher than that of the advertising node (see Section 5.13.1)normal situation.~~¹
- d) n/a.
- e) equivalent to 5.14.9.5.1~~5.14.8.5.1~~ e).¹

5.14.9.5.3 Nodal State Parameters **IGTLV**

The following cases only apply to **IGTLV**s where the '**NodalComplex Representation**'-Bit is set (i.e., the node is complex)¹.

- a) not applicable
- b) if a nodal state **parameters IGTLV** appears multiple times inside of a single PTSE only the first one is used for any state-significant computations (even if the service category sets defined do not intersect). This includes the default spoke.
- c) default spoke does not appear. ~~Any PTSE of the node is ignored for the sake of state significant computations except for vi). Such a node can be used to compute reachability to other nodes in the network for the sake of e.g. peer group leader election but its PTSEs like e.g. horizontal links cannot be used for the sake of path computation. Spokes of this node may not be used in state-significant computations unless exceptions are advertised for both directions, except for vi)/5.14.9.4. This does not affect iv)/5.14.9.4 (PGL election), v)/5.14.9.4 (computation of hierarchy to be advertised in outside hellos), or vi)/5.14.9.4 (reachability computation).~~¹
- d) n/a.
- e) if a nodal state **parameters IG** appears multiple times in different PTSEs (even if the service category sets defined do not intersect), only the one appearing in the PTSE with the lowest ID is used for state-significant computations.

If the node does not have the '**NodalComplex Representation**'-Bit set (i.e., the node is complex)¹.

- a) if nodal state **IGTLV**s appear they are ignored for the sake of any state-significant computations
- b) not applicable.
- c) not applicable.
- d) n/a.
- e) analog a).

5.14.9.5.4 Horizontal Link **IGTLV**

- a) not applicable
- b) if such **IGTLV** appears multiple times inside of a single PTSE only the first one is used for any state-significant computations (even if the service category sets defined do not intersect).
- c) not applicable
- d) n/a.
- e) if a **IGTLV** appears multiple times in different PTSEs (even if the service category sets defined do not intersect), only the one appearing in the PTSE with the lowest ID is used for state-significant computations. This rule also applies when a horizontal link IG and an uplink IG appear (necessarily in different PTSEs) with the same value for the local port ID.¹

5.14.9.5.5 Uplink **IGTLV**

Equivalent to 5.14.9.5.4~~5.14.8.5.4~~¹

5.14.9.5.6 ULIA

- a) not applicable
- b) if multiple ULIAs appear in an uplink **IGTLV**, only the first one is used for state-significant computations.
- c) ~~not applicable~~if an uplink IE does not have a ULIA associated with it, then the link can not be used for state-significant computations (e.g. link aggregation) and route computation.¹
- d) n/a.
- e) not applicable

5.14.9.5.7 RAIGs

If a service category appears in multiple RAIGs within a horizontal link, uplink, nodal state parameters, or ULIA IG, then only the ~~one appearing in the~~ first RAIG ~~in which this service category appears applies is used~~ for ~~this service category in~~¹ state-significant computations.

5.14.9.6 Nodal Information PTSE and its connection to other PTSEs issued by the node

Since nodal information PTSE carries several important flags and specifications of the advertising node ~~issuing~~, it is important to specify the semantics of a set of PTSEs that has been received without the appropriate nodal information PTSE being present. To improve the stability of the protocol all state-significant computations ~~except vi) should shall~~¹ ignore PTSEs for which a valid nodal information PTSE is not present. ~~Path computation can omit this restriction, however it should not be forgotten that e.g. paths computed through a node's complex representation are not valid after nodal info PTSE is received that specifies that the node does not have a complex representation.~~¹

5.14.10 PTSE Acknowledgment Packets

PTSE Acknowledgment Packets are used to acknowledge the receipt of PTSEs from a neighbor node. Each PTSE Acknowledgment Packet consists of multiple nodal PTSE acknowledgment information groups. Each information group is used to acknowledge the receipt of multiple PTSEs with the same originating node and transmitted by the same neighbor node, by including the PTSE identifying information for each acknowledged PTSE.

Table 5-41: The PTSE Acknowledgement Packet

Offset	Size (Octets)	Name	Function/Description
0	8	PNNI Header	A PNNI packet header structure with Packet type = 3 (PTSE acknowledgment packet). See Table 5-20.
Repeat for each set of PTSE acknowledgments about one node:			
	2	Type	Type = 384 (Nodal PTSE acknowledgment)
	2	Length	
	22	Node ID	
	2	AckCount	The number of acknowledgments for this node.
Repeat the following structure AckCount times:			
	4	PTSE Identifier	
	4	PTSE Sequence Number	
	2	PTSE Checksum	
	2	PTSE Remaining Lifetime	

5.14.11 Database Summary Packets

Database summary packets are used during the initial database exchange process between two neighboring peers. During the database exchange process, database summary packets are sent containing the PTSP and PTSE header information of all PTSEs in a node's topology database. Database summary packets also contain a sequence number and flags used to negotiate the master/slave relationship necessary to ensure proper functioning of the lock-step protocol.

Table 5-42: The Database Summary Packet

Offset	Size (Octets)	Name	Function/Description
0	8	PNNI Header	A PNNI packet header structure with Packet type = 4 (Database summary packet). See Table 5-20.
8	2	Flags	See Table 5-43.
10	2	<i>Reserved</i>	
12	4	DS sequence number	
Repeat for each set of PTSEs in the topology database:			
	2	Type	Type = 512 (Nodal PTSE summaries)
	2	Length	
	22	Originating node ID	
	14	Originating node's Peer Group ID	
	2	<i>Reserved</i>	
	2	PTSE Summary Count	The number of PTSE summaries for this originating node ID.
Repeat the following structure PTSE Summary Count times:			
	2	PTSEType	
	2	<i>Reserved</i>	
	4	PTSE Identifier	
	4	PTSE Sequence Number	
	2	PTSE Checksum	
	2	PTSE Remaining Lifetime	

Table 5-43: Database Summary Packet Flags

Bit ID:	bit 16 (MSB)	bit 15	bit 14	bits 13..1 (LSB)
Bit Name:	'Initialize' (I) bit	'More' (M) bit	'Master' (MS) bit	<i>Reserved</i>
Description:	Set to one during initialization of the database synchronization process. Otherwise set to zero.	Set to one if the transmitting node has additional PTSEs to summarize, or zero if all PTSEs have been summarized (see Section 5.7.5).	Set to one initially by both nodes. Later set to zero by the node that assumes the slave role in the database synchronization process.	

5.14.12 PTSE Request Packets

PTSE request packets are used during database synchronization to request from a neighboring peer those PTSEs that have been newly discovered or that have been found to be obsolete.

Table 5-44: The PTSE Request Packet

Offset	Size (Octets)	Name	Function/Description
0	8	PNNI Header	A PNNI packet header structure with Packet type = 5 (PTSE request packet). See Table 5-20.
Repeat for each set of PTSEs requested:			
	2	Type	Type = 513 (Nodal PTSE request list)
	2	Length	
	22	Originating Node ID	
	2	PTSE Request Count	The number of PTSEs requested for this originating node ID.
Repeat PTSE Request Count times:			
	4	PTSE Identifier	

5.14.13 System Capabilities

Systems may indicate support for optional PNNI capabilities by including the “Systems Capabilities” IG in PNNI packets. This may be used to indicate support for standard capabilities (specified by the ATM Forum), and proprietary capabilities (which may be specified by individual equipment manufacturers).

The interpretation of the system capabilities IG depends on where it occurs. If it occurs at the top level of a packet it describes system capabilities of the sender of that packet, i.e., the neighbor node. If it occurs within a PTSE, it describes the system capabilities of the PTSE originator.

The system capabilities IG MAY optionally be included at ~~the top any~~ level in any PNNI packets (specifically including Hellos, Database Summary Packets, and PTSPs) and also in a PTSE, ~~as well as but not~~¹ within an information group inside of a PTSE. Also, this field may occur multiple times (for example, it may be desirable to identify both extended standard capabilities as well as proprietary capabilities).

In the system capabilities IG the IEEE OUI is considered to be logically included as part of the IG type. If a system capabilities IG is received with an IEEE OUI that is not defined to occur in the containing IG, the system capabilities IG must be treated as an unknown information group. This is distinct from the case of a restricted information group appearing in a PTSE with a PTSEType that does not match, since the specified information group tags must be processed for unknown information groups.¹

For IGs appearing within the system capabilities information group, the context of the containing information group is given by the value of the IEEE OUI as well as the IG type (i.e. system capabilities). The type values of child IGs need only be unique among all possible type values defined to occur within a system capabilities information group with the same IEEE OUI value.¹

Table 5-45: The Systems Capabilities IG

Offset	Size (Octets)	Name	Function/Description
0	2	Type	Type=640 (system capabilities)
2	2	Length	
4	2	Length of system capabilities contents	Length of IEEE OUI + System Capabilities Information.
6	3	IEEE OUI	IEEE Organizationally Unique Identifier, reference IEEE Standard 802-1990.
9	n	System capabilities information	The semantics of this field are administered by the organization identified by the OUI.
9 + n	0..3	Padding	The size of the Padding field is calculated using the following formula: (4 - [(5+n) modulus 4]) modulus 4

Standard capabilities may be specified by the ATM Forum, using the OUI assigned to the Forum. Currently, there are no defined system capabilities which may be announced using the ATM Forum OUI.

The system capabilities advertised by an LGN represent the capabilities of its child peer group and/or of the LGN implementation.

6. PNNI Signalling Specification

This specification contains the procedures to dynamically establish, maintain and clear ATM connections at the Private network-to-network interface or network node interface (PNNI) between two ATM networks or two ATM network nodes. The PNNI signalling protocol is based on the ATM Forum UNI specification and for the finite state machine definition and the specification of symmetrical interactions, it is derived from the Frame Relay NNI signalling defined in ITU-T ~~draft~~ Recommendation Q.934X.76 [44]. The procedures are defined in terms of messages and information elements used to characterize the ATM connection.

Whenever possible, the following sections refer directly to the UNI Signalling 4.1 specification. The UNI Signalling 4.1 specification itself is a pointer to ITU-T Recommendation Q.2931 [38] (and applicable amendments) with a list of clarifications. When reference to specific sections of UNI Signalling 4.1 is not possible, the following sections refer directly to ITU-T Recommendation Q.2931.

It shall be understood that references to a section of Q.2931 are to the section as modified by UNI Signalling 4.1, Amendment 2 of Q.2931 [39], Corrigendum to Amendment 2 of Q.2931 [40], and Amendment 4 of Q.2931 [41]. e.g. a reference to 4.5.5/Q.2931 would be to the revised text in Amendment 2 of Q.2931.³

6.1 PNNI model

A network configuration is shown in Figure 6-1 to help clarify terminology.

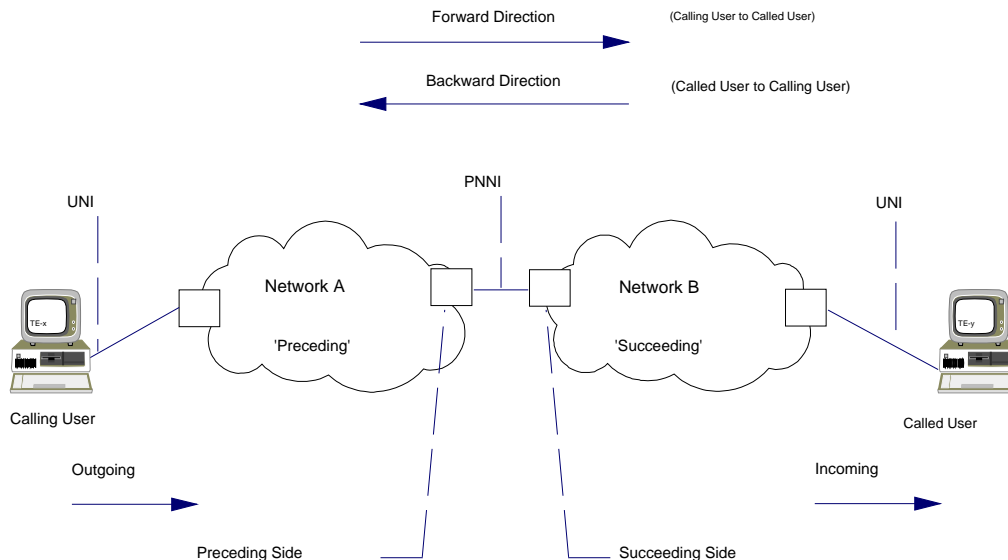

Figure 6-1: PNNI interface

In addition, the model used in the signalling procedures uses two types of primitives exchanged between a Call Control entity and Protocol Control entities within a Switching System. This is depicted in Figure 6-1a.³

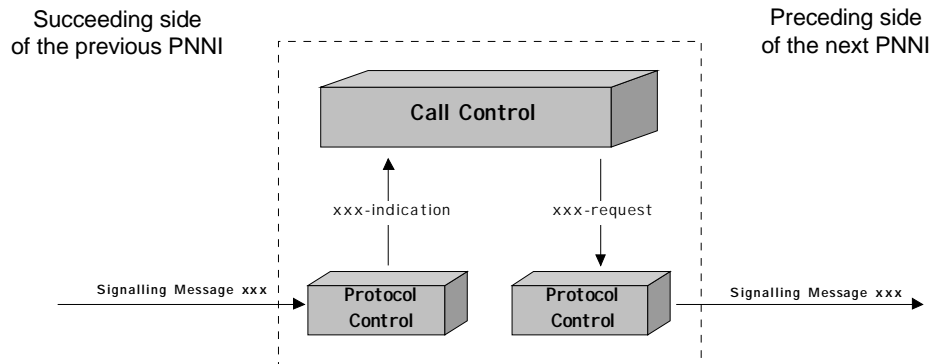

Figure 6-1a: Primitives used in the Signalling specification sections

6.1.1 Definitions

Forward/Backward direction: The forward direction is the direction from the calling user to the called user. The backward direction is the direction from the called user to the calling user.

Preceding/Succeeding side: A preceding side is a network node that comes before another network node in the call/connection setup path. A succeeding side is a network node that comes after another network node in the call/connection setup path.

“Indication” primitive: The reception by the Protocol Control entity of a signalling message over an interface triggers the sending of a corresponding "indication" primitive to the Call Control entity.

“Request” primitive: The reception by the Protocol Control entity of a "request" primitive from the Call Control entity triggers the sending of the corresponding signalling message over the interface.³

6.1.2 Protocol model

The figure below shows, within the control plane, the relationship between the signalling procedures and the underlying services.

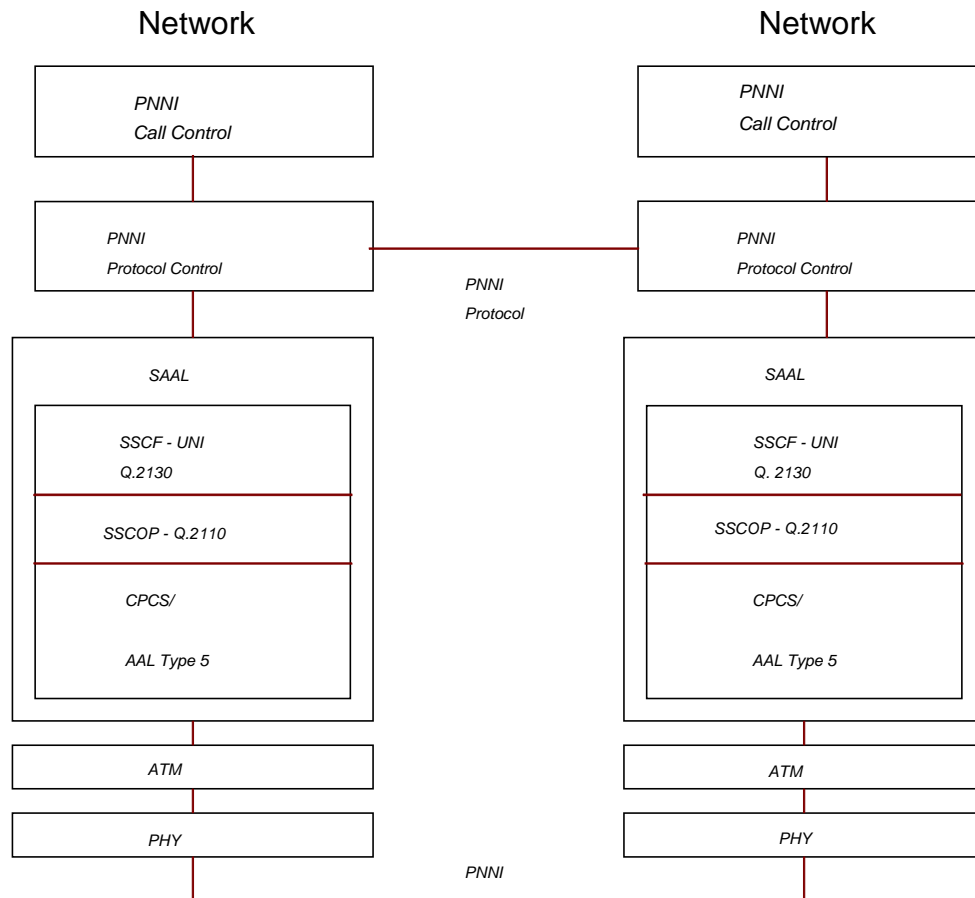

Figure 6-2: PNNI Control Plane

6.1.2.1 Signalling layer

The signalling layer contains two distinct entities: PNNI call control and PNNI protocol control. The PNNI call control services the upper layers for functions such as resource allocation and routing information. The PNNI protocol control entity provides services to the PNNI call control. Primitives exchanged across the boundary between call control and protocol control correspond to the information flows exchanged between the call control functional entities.

The PNNI protocol control processes the actual signalling finite state machines (incoming and outgoing calls) using symmetric procedures.

6.1.2.2 Signalling adaptation layer

The PNNI signalling symmetric procedures use the services of the UNI Signalling ATM Adaptation Layer (SAAL). The SAAL layer comprises:

- a) A Service Specific Coordination Function (SSCF) as specified in ITU-T Recommendation Q.2130. This function maps the service of the Service Specific Connection Oriented Protocol (SSCOP) to the needs of the signalling procedures.
- b) The service specific connection oriented protocol as specified in ITU-T Recommendation Q.2110. This assured service provides a peer-to-peer protocol to transfer signalling information between any pair of SSCOP entities.
- c) The ATM Adaptation Layer Type 5 (AAL-5) CPCS and SAR sublayers as specified in ITU-T Recommendation I.363. This service provides segmentation and reassembly of signalling data units per ATM layer cell structure requirements.

6.1.2.3 ATM layer

The ATM layer as specified in ITU-T Recommendation I.150, provides for the transparent transfer of fixed size ATM layer service data units (ATM-SDUs) between communicating AAL entities. The structure of the cell header used in the PNNI is the cell header format and encoding at NNI (see Figure 3/I.361). Any bits of the VPI or VCI subfield that are not allocated are set to '0'.

6.2 Overview of Call/connection control

This section defines the call control states that individual calls may have. These definitions do not apply to the state of the interface itself, any attached equipment, or the signalling virtual channel. Because several calls may exist simultaneously at a PNNI and each call may be in a different state, the state of the interface cannot be unambiguously defined.

6.2.1 ATM Point-to-point call states

This section defines the point-to-point call control states for ATM calls at both sides of a PNNI between preceding and succeeding sides.

6.2.1.1 Null (NN0)

No call exists.

6.2.1.2 Call Initiated (NN1)

This state exists in a succeeding side after it has received a call establishment request from the preceding network node but has not yet responded.

6.2.1.3 Call Proceeding Sent (NN3)

This state exists when a succeeding side has acknowledged the receipt of the information necessary to establish a call.

6.2.1.4 Alerting Delivered (NN4)

This state exists when a succeeding side has sent an ALERTING message to the preceding side.

6.2.1.5 Call Present (NN6)

This state exists at a preceding side after it has sent a call establishment request to the succeeding side but has not yet received a response.

6.2.1.6 Alerting Received (NN7)

This state exists when a preceding side has received an ALERTING message from the succeeding side of the PNNI interface.

6.2.1.7 Call Proceeding Received (NN9)

This state exists when a preceding side has received acknowledgment that the succeeding side has received the call establishment request.

6.2.1.8 Active (NN10)

This state exists when the ATM connection has been established.

6.2.1.9 Release Request (NN11)

This state exists when a network node has sent a request to the network node at the other side of the PNNI interface to release the ATM connection and is waiting for the response.

6.2.1.10 Release Indication (NN12)

This state exists when a network node has received a request from the network node at the other side of the PNNI interface to release the ATM connection and has not responded yet.

6.2.2 States associated with global call reference

~~For clarity, the section refers to ITU-T Recommendation Q.2931 section numbers because UNI 4.0 is a pointer to Q.2931 with a list of clarifications. It should be understood that modifications described in UNI 4.0 signalling specification shall apply.³~~

See section 2.3 of Recommendation Q.2931.

6.3 Message functional definitions and contents

This section provides an overview of the message structure, which highlights the functional definitions and information content (i.e., semantics) of each message. Each definition includes:

1. A brief description of the message direction and use, including whether the message has:
 - a) Local significance, i.e., relevant only at the local PNNI, or
 - b) Access significance, i.e., relevant at the originating and terminating access, but not in the network, or
 - c) Global significance, i.e., relevant at the local PNNI, other PNNIs and UNIs related to the call.
2. A table listing the codeset 0 (ITU-T [CCITT] standardized) information elements. For each information element the table indicates:
 - a) the section of this Implementation Agreement describing the information element;
 - b) whether inclusion is mandatory ('M') or optional ('O'), with a reference to notes explaining the circumstances under which the information element shall be included; and
 - c) the length of the information element (or permissible range of lengths), in octets.
3. Further explanatory notes, as necessary.

In view of the symmetrical nature of the protocol at the PNNI, the reference model used in this section considers a PNNI link connecting two network nodes which are identified as a Preceding side and a Succeeding side, where the direction of flow is that of the call. In the context of a call, the Preceding side routes the call over the PNNI link and the Succeeding side receives the call.

From the point of view of the Preceding side, a call is an outgoing call.

From the point of view of the Succeeding side, a call is an incoming call.

6.3.1 Messages for ATM point-to-point call and connection control

Table 6-1 summarizes the messages for ATM point-to-point call and connection control.

Table 6-1: Messages for ATM Call and Connection Control³

Message	Reference
Call establishment messages:	
ALERTING	6.3.1.1
CALL PROCEEDING	6.3.1.2
CONNECT	6.3.1.3
SETUP	6.3.1.6
Call clearing messages:	
RELEASE	6.3.1.4
RELEASE COMPLETE	6.3.1.5
Miscellaneous messages:	
<u>CO-BI SETUP</u>	<u>26.8.1.3.2 of [8]</u>
<u>CONNECTION AVAILABLE</u>	<u>6.3.1.10</u>
<u>FACILITY</u>	<u>26.8.1.2.1 of [8]</u>
<u>MODIFY ACKNOWLEDGE</u>	<u>2.1.2.2 of [21]</u>
<u>MODIFY REJECT</u>	<u>2.1.2.3 of [21]</u>
<u>MODIFY REQUEST</u>	<u>2.1.2.1 of [21]</u>
NOTIFY	6.3.1.9
STATUS	6.3.1.7
STATUS ENQUIRY	6.3.1.8
<u>TRACE CONNECTION</u>	<u>5.2 of [19]</u>
<u>TRACE CONNECTION ACKNOWLEDGE</u>	<u>5.2 of [19]</u>

6.3.1.1 ALERTING

This message is sent by the succeeding side to indicate that called user alerting has been initiated.

Message Type: ALERTING
 Direction: Succeeding to Preceding
 Significance: Global

Information Element	Reference	Type	Length ³
Protocol discriminator	6.4.2	M	1
Call reference	6.4.3	M	4
Message type	6.4.4.1	M	2
Message length	6.4.4.2	M	2
<u>Broadband report type³</u>	<u>6.4.5.33</u>	<u>O(2)</u>	<u>5</u>
Endpoint reference	6.4.8.1	O(1)	4-7 <u>7</u>
Notification indicator	6.4.5.27	O(2)	4-5 <u>5</u> -*
Generic identifier transport	6.4.5.31	O(2,3)	4-33 <u>7-63</u>
<u>User-user³</u>	<u>6.4.5.32</u>	<u>O(2)</u>	<u>6-133</u>

Note 1 - Mandatory if an Endpoint reference was included in the SETUP message.

Note 2 - Included if the received alerting requestindication³ contains this information.

Note 3 - This information element may be present up to 3 times.

Figure 6-3: ALERTING Message Contents

6.3.1.2 CALL PROCEEDING

This message is sent by the Succeeding side to indicate that the requested call/connection establishment has been initiated and no more call establishment information will be accepted.

Message Type: CALL PROCEEDING
 Direction: Succeeding to Preceding
 Significance: Local

Information Element	Reference	Type	Length ³
Protocol discriminator	6.4.2	M	1
Call reference	6.4.3	M	4
Message type	6.4.4.1	M	2
Message length	6.4.4.2	M	2
Connection identifier	6.4.5.22	M	9
Endpoint reference	6.4.8.1	O(1)	4-7 <u>7</u>

Note 1 - Mandatory if an Endpoint reference was included in the SETUP message.

Figure 6-4: CALL PROCEEDING Message Contents

6.3.1.3 CONNECT

This message is sent by the Succeeding side and delivered to the Preceding side to indicate call/connection acceptance by the called user.

Message Type: CONNECT
 Direction: Succeeding to Preceding
 Significance: Global

Information Element	Reference	Type	Length ³
Protocol discriminator	6.4.2	M	1
Call reference	6.4.3	M	4
Message type	6.4.4.1	M	2
Message length	6.4.4.2	M	2
ABR-ATC additional parameters	6.4.5.5	O(1)	4-14 14
ABR-ATC setup parameters	6.4.5.6	O(1)	4-36 6-36
AAL parameters	6.4.5.8	O(1)	4-11 5-30
ATM traffic descriptor	6.4.5.9	O(4)	4-30 6-30
Broadband low layer information	6.4.5.12	O(1)	4-17 5-20
<u>Broadband report type³</u>	<u>6.4.5.33</u>	<u>O(1,6)</u>	<u>5</u>
Called party Soft PVPC or PVCC	6.4.6.2	O(2)	4-11 8-11
Connected number	6.4.5.20	O(1)	4-26 6-26
Connected sub-address	6.4.5.21	O(1)	4-25 6-25
Endpoint reference	6.4.8.1	O(3)	4-7 7
End-to-end transit delay	6.4.5.24	O(1)	4-7 7
Extended QoS parameters	6.4.5.25	O(1)	4-13 7-13
Generic identifier transport	6.4.5.31	O(1,5)	4-33 7-63
Notification indicator	6.4.5.27	O(1)	4-* 5-*
<u>User-user³</u>	<u>6.4.5.32</u>	<u>O(1)</u>	<u>6-133</u>

Note 1 - Included if the received connect requestindication³ contains this information.

Note 2 - Included in case of Soft PVPC or PVCC setup.

Note 3 - Mandatory if the Endpoint reference was included in the SETUP message.

Note 4 - Mandatory if the calling user requested an ABR traffic category connection.

Note 5 - May be present up to three times.

Note 6 - May be present twice.³

Figure 6-5: CONNECT Message Contents

6.3.1.4 RELEASE

This message is sent by a network node to an adjacent network node to indicate that it has cleared the connection and is waiting to release the call reference.

Message Type: RELEASE
 Direction: Both
 Significance: Global

Information Element	Reference	Type	Length ³
Protocol discriminator	6.4.2	M	1
Call reference	6.4.3	M	4
Message type	6.4.4.1	M	2
Message length	6.4.4.2	M	2
Cause	6.4.5.19	M(1)	6-34
Crankback	6.4.6.3	O(2)	4-72 7-72
Notification indicator	6.4.5.27	O(3)	4-* 5-*
Generic identifier transport	6.4.5.31	O(3,4)	4-33 7-63
<u>User-user³</u>	<u>6.4.5.32</u>	<u>O(3)</u>	<u>6-133</u>

- Note 1 - This information element may appear twice in the message.
 Note 2 - Included to indicate crankback.
 Note 3 - Included if the received release requestindication³ contains this information.
 Note 4 - This information element may be present up to 3 times.

Figure 6-6: RELEASE message content

6.3.1.5 RELEASE COMPLETE

This message is sent by a network node to an adjacent network node to indicate that it has cleared internally the connection (if any) and released the call reference.

Message Type: RELEASE COMPLETE
 Direction: Both
 Significance: Local (Note 1)

Information Element	Reference	Type	Length ³
Protocol discriminator	6.4.2	M	1
Call reference	6.4.3	M	4
Message type	6.4.4.1	M	2
Message length	6.4.4.2	M	2
Cause	6.4.5.19	O(2)	4-34 6-34
Crankback	6.4.6.3	O(3)	4-72 7-72

- Note 1 - This message has local significance; however, it may carry information of global significance when used as the first call clearing message.
 Note 2 - Mandatory in the first call clearing message; including when the RELEASE COMPLETE message is sent as a result of an error condition. This information element may appear twice in the message.
 Note 3 - Included to indicate crankback.

Figure 6-7: RELEASE COMPLETE message content

6.3.1.6 SETUP

This message is sent by Preceding side to Succeeding side to initiate call/connection establishment.

Message Type: SETUP
 Direction: Preceding to Succeeding
 Significance: Global

Information Element	Reference	Type	Length ³
Protocol discriminator	6.4.2	M	1
Call reference	6.4.3	M	4
Message type	6.4.4.1	M	2
Message length	6.4.4.2	M	2
AAL parameters ³	6.4.5.8	O(1,13)	4-21 5-30
ABR-ATC additional parameters	6.4.5.5	O(1)	4-14 14
ABR-ATC setup parameters	6.4.5.6	O(11)	4-36 6-36
Alternative ATM traffic descriptor	6.4.5.7	O(12)	4-30 12-30
ATM traffic descriptor	6.4.5.9	M	12-30
Broadband bearer capability	6.4.5.10	M	6-7
Broadband high layer information	6.4.5.11	O(1)	4-13 5-13
Broadband repeat indicator	6.4.5.13	O(6)	4-5 5
Broadband low layer information	6.4.5.12	O(1)	4-17 5-20
<u>Broadband report type³</u>	<u>6.4.5.33</u>	<u>O(1,13)</u>	<u>5</u>
Called party number	6.4.5.15	M	(2)
Called party Soft PVPC or PVCC	6.4.6.2	O(4)	4-11 8-11
Called party subaddress	6.4.5.16	O(1)	4-25 6-25
Calling party number	6.4.5.17	O(1)	4-26 6-26
Calling party Soft PVPC or PVCC	6.4.6.1	O(3)	4-10 7-10
Calling party subaddress	6.4.5.18	O(1)	4-25 6-25
Connection identifier	6.4.5.22	O(5)	4-9 9
Connection scope selection	6.4.5.23	O(1)	4-6 6
Designated transit list	6.4.6.4	M(7)	33-546
Endpoint reference	6.4.8.1	O(1)	4-7 7
End-to-end transit delay	6.4.5.24	O(8)	4-13 7-13
Extended QoS parameters	6.4.5.25	O(10)	4-25 7-25
Generic identifier transport	6.4.5.31	O(1,9)	4-33 7-63
Minimum acceptable ATM traffic descriptor	6.4.5.26	O(12)	4-20 8-28
Notification indicator	6.4.5.27	O(1)	4-* 5-*
QoS parameter	6.4.5.28	O(1)	4-6 6
Transit network selection	6.4.5.30	O(1)	4-9 6-9
<u>User-user³</u>	<u>6.4.5.32</u>	<u>O(1)</u>	<u>6-133</u>

- Note 1 - Included if the received setup ~~request~~^{indication}³ contains this information.
- Note 2 - Minimum length depends on the numbering plan. Maximum length is 25 octets.
- Note 3 - May be included in case of Soft PVPC or PVCC setup, when the calling endpoint wants to inform the destination network interface of the values used for the PVPC or PVCC segment at the calling end.
- Note 4 - Included in case of Soft PVPC or PVCC setup.
- Note 5 - Included when Preceding side wants to indicate a specific virtual path or virtual channel. If not included, its absence is interpreted as any virtual path or virtual channel is acceptable. This information element may only be absent when using the non-associated signalling procedures.
- Note 6 - When the Broadband repeat indicator information element immediately precedes the DTL information element, it indicates the order of Designated transit list information elements in the DTL stack. This information element is mandatory, even when there is only one Designated transit list information element. When the Broadband repeat indicator information element immediately precedes any other information element, it is included if the received setup ~~request~~^{indication}³ contains this information
- Note 7 - Included by the source node to indicate the hierarchical source route for the call. Included by the node at the entry to a hierarchical level to indicate the path through that hierarchical level. This information element may be repeated up to 10 times. The sum of the lengths of these DTL information elements should be less than or equal to 1400. Note that if the message length exceeds the maximum message length supported by SAAL, the call will be cleared.³
- Note 8 - Included to specify an end-to-end transit delay requirement.
- Note 9 - This information element may be present up to three times.
- Note 10 - Included to specify individual QoS parameter requirements for the call.
- Note 11 - Mandatory if the calling user requested an ABR traffic category connection.
- Note 12 - May only be present when this information is present in the received setup ~~request~~^{indication}³.
- Note 13 - May be present twice.³

Figure 6-8: SETUP message content

6.3.1.7 STATUS

This message is sent by either side in response to a STATUS ENQUIRY message or at any time to report certain error conditions.

Message type: STATUS
 Direction: Both
 Significance: Local

Information Element	Reference	Type	Length ³
Protocol discriminator	6.4.2	M	1
Call reference	6.4.3	M ⁽³⁾	4
Message type	6.4.4.1	M	2
Message length	6.4.4.2	M	2
Call state	6.4.5.14	M	5
Cause	6.4.5.19	M	6-34
Endpoint reference	6.4.8.1	O(1)	4-7 ⁷
Endpoint state	6.4.8.2	O(2)	4-5 ⁵

Note 1 - Included when responding to a status enquiry about a single³ party state or at any time to report certain error conditions in the point-to-multipoint procedures.

Note 2 - Included when the Endpoint reference information element is included.

Note 3 - This message may be sent with the global call reference.³

Figure 6-9: STATUS message content

6.3.1.8 STATUS ENQUIRY

The STATUS ENQUIRY message may be sent by either side at any time to solicit a STATUS message from the peer entity. Sending a STATUS message in response to a STATUS ENQUIRY message is mandatory.

Message type: STATUS ENQUIRY
 Direction: Both
 Significance: Local

Information Element	Reference	Type	Length ³
Protocol discriminator	6.4.2	M	1
Call reference	6.4.3	M	4
Message type	6.4.4.1	M	2
Message length	6.4.4.2	M	2
Endpoint reference	6.4.8.1	O(1)	4-7 ⁷

Note 1 - Included when enquiring about a single³ party state in the point-to-multipoint procedures.

Figure 6-10: STATUS ENQUIRY message content

6.3.1.9 NOTIFY

This message is sent by either side to indicate information pertaining to a call/connection.

Message type: NOTIFY
 Direction: Both
 Significance: Access

Information Element	Reference	Type	Length ³
Protocol discriminator	6.4.2	M	1
Call reference	6.4.3	M	4
Message type	6.4.4.1	M	2
Message length	6.4.4.2	M	2
Endpoint reference	6.4.8.1	O(1)	4-7 7
Notification indicator	6.4.5.27	M	5-*

Note 1 - Included if the received notify ~~request~~^{indication}³ contains this information.

Figure 6-11: NOTIFY message content

6.3.1.10 CONNECTION AVAILABLE³

This message is passed without change by PNNI to confirm the availability of a connection from the calling user to the called user.

Message type: CONNECTION AVAILABLE
Direction: Preceding to Succeeding
Significance: Global

<u>Information Element</u>	<u>Reference</u>	<u>Type</u>	<u>Length³</u>
<u>Protocol discriminator</u>	<u>6.4.2</u>	<u>M</u>	<u>1</u>
<u>Call reference</u>	<u>6.4.3</u>	<u>M</u>	<u>4</u>
<u>Message type</u>	<u>6.4.4.1</u>	<u>M</u>	<u>2</u>
<u>Message length</u>	<u>6.4.4.2</u>	<u>M</u>	<u>2</u>
<u>Notification indicator</u>	<u>6.4.5.27</u>	<u>O(1)</u>	<u>5-*</u>
<u>Security services</u>	<u>4 of [12]</u>	<u>O</u>	<u>12-512</u>
<u>Broadband report type</u>	<u>6.4.5.33</u>	<u>O(1)</u>	<u>5</u>
<u>Generic identifier transport</u>	<u>6.4.5.31</u>	<u>O(1,2)</u>	<u>7-33</u>
<u>Generic application transport</u>	<u>3.1 of [16]</u>	<u>O(3)</u>	<u>6-512</u>
<u>User-user</u>	<u>6.4.5.32</u>	<u>O(1)</u>	<u>6-133</u>

Note 1 - Included if it was contained in the received connection available request.

Note 2 - This information element may be present up to 3 times.

Note 3 - This information element may be present up to 5 times.

Figure 6-11a: CONNECTION AVAILABLE message content

6.3.2 Additional or modified messages for the support of 64kbit/s based ISDN circuit mode services

Table 6-2 summarizes the messages for ATM call and connection control for the support of 64 kbit/s based ISDN circuit-mode services.

Except where explicitly identified in the procedures, the information elements added in this section are transported without change across the PNNI.

Table 6-2: Messages for ATM call/ connection control for the support of 64 kbit/s based ISDN circuit code services

Message	Reference
Call establishment messages:	
ALERTING	6.3.2.1
CONNECT	6.3.2.2
PROGRESS	6.3.2.3
SETUP	6.3.2.5
Call clearing messages:	
RELEASE	6.3.2.4

6.3.2.1 ALERTING

This message is sent by the succeeding side to indicate that the called user alerting has been initiated, if ALERTING is received.

Message Type: ALERTING
 Direction: Succeeding to Preceding
 Significance: Global

Information Element	Reference	Type	Length ³
Narrow-band bearer capability	6.4.7.1	O(1)	4-14 <u>6-14</u>
Narrow-band high layer compatibility	6.4.7.2	O(1)	4-7 <u>5-7</u>
Progress indicator	6.4.7.4	O(1,2)	4-6 <u>6</u>
Other information elements as described in subclause 6.3.1.1.			

Note 1 - Included if the received alerting ~~request~~indication³ contains this information.

Note 2 - May appear twice in the message.

Figure 6-12: ALERTING message contents

6.3.2.2 CONNECT

This message is sent by the Succeeding side and delivered to the Preceding side to indicate call/connection acceptance by the called user.

Message Type: CONNECT
 Direction: Succeeding to Preceding
 Significance: Global

Information Element	Reference	Type	Length ³
Narrow-band bearer capability	6.4.7.1	O(1)	4-14 6-14
Narrow-band high layer compatibility	6.4.7.2	O(1)	4-7 5-7
Narrow-band low layer compatibility	6.4.7.3	O(1)	4-20 5-20
Progress indicator	6.4.7.4	O(1,2)	4-6 6
Other information elements as described in subclause 6.3.1.3.			

Note 1 - Included if the received connect ~~request~~indication³ contains this information.

Note 2 - May appear twice in the message.

Figure 6-13: CONNECT message contents

6.3.2.3 PROGRESS

This message is passed without change by PNNI to indicate the progress of a call in the event of interworking.

Message Type: PROGRESS
 Direction: Succeeding to Preceding
 Significance: Global

Information Element	Reference	Type	Length ³
Protocol discriminator	6.4.2	M	1
Call reference	6.4.3	M	4
Message type	6.4.4.1	M	2
Message length	6.4.4.2	M	2
Narrow-band bearer capability	6.4.7.1	O(1)	4-14 6-14
Narrow-band high layer compatibility	6.4.7.2	O(1)	4-7 5-7
Notification indicator	6.4.5.27	O(1,2)	4-* 5-*
Progress indicator	6.4.7.4	O(1)	4-6 6
User-user ³	6.4.5.32	O(1)	6-133

Note 1 - Included if the received progress ~~request~~indication³ contains this information.

Note 2 - May appear twice in the message.

Figure 6-14: PROGRESS message contents

6.3.2.4 RELEASE

This message is sent by a network node to an adjacent node to indicate that it has cleared the connection and is waiting to release the call reference.

Message Type: RELEASE
 Direction: Both
 Significance: Global

Information Element	Reference	Type	Length ³
Progress indicator	6.4.7.4	O(1,2)	4-6 <u>6</u>
Other information elements as described in subclause 6.3.1.4.			

- Note 1 - Included if the received release requestindication³ contains this information.
 Note 2 - May appear twice in the message.

Figure 6-15: RELEASE message content

6.3.2.5 SETUP

This message is sent by Preceding side to Succeeding side to initiate call/connection establishment.

Message Type: SETUP
 Direction: Preceding to Succeeding
 Significance: Global

Information Element	Reference	Type	Length ³
Narrow-band bearer capability	6.4.7.1	O(1,2)	4-14 <u>6-14</u>
Narrow-band high layer compatibility	6.4.7.2	O(1,3)	4-7 <u>5-7</u>
Broadband repeat indicator	6.4.5.13	O(1,4)	4-5 <u>5</u>
Narrow-band low layer compatibility	6.4.7.3	O(1,4)	4-20 <u>5-20</u>
Progress indicator	6.4.7.4	O(1,3)	4-6 <u>6</u>
Other information elements as described in subclause 6.3.1.6.			

- Note 1 - Included if the received setup requestindication³ contains this information.
 Note 2 - May be present up to three times in the message.
 Note 3 - May be repeated twice in the message.
 Note 4 - The Broadband repeat indicator is included when two Narrow-band low layer compatibility information elements are included. Refer to Q.2931, Section 3.2.7, table 3-19, for details.

Figure 6-16: SETUP message content

6.3.3 Messages used with the global call reference

Table 6-3: Messages Used with the Global Call Reference

Message	Reference
RESTART	6.3.3.1
RESTART ACKNOWLEDGE	6.3.3.2
STATUS	6.3.1.7
<u>STATUS ENQUIRY</u> ³	18.3.1.2

6.3.3.1 RESTART

This message is sent by either side to request the recipient to restart (i.e., release all resources associated with) the indicated virtual channel/path or all virtual channels/paths controlled by the signalling virtual channel.

Message type: RESTART
 Direction: Both
 Significance: Local

Information Element	Reference	Type	Length ³
Protocol discriminator	6.4.2	M	1
Call reference	6.4.3	M(1)	4
Message type	6.4.4.1	M	2
Message length	6.4.4.2	M	2
Connection identifier	6.4.5.22	O(2)	4 <u>9</u>
Restart indicator	6.4.5.29	M	5

Note 1 - This message is sent with the global call reference.

Note 2 - Included when necessary to indicate the particular virtual channel or virtual path to be restarted.

Figure 6-17: RESTART message content

6.3.3.2 RESTART ACKNOWLEDGE

This message is sent to acknowledge the receipt of a RESTART message and to indicate that the requested restart is complete.

Message type: RESTART ACKNOWLEDGE
 Direction: Both
 Significance: Local

Information Element	Reference	Type	Length ³
Protocol discriminator	6.4.2	M	1
Call reference	6.4.3	M(1)	4
Message type	6.4.4.1	M	2
Message length	6.4.4.2	M	2
Connection identifier	6.4.5.22	O(2)	4 <u>9</u>
Restart indicator	6.4.5.29	M	5

Note 1 - This message is sent with the global call reference.

Note 2 - Included when necessary to indicate the particular virtual channel or virtual path which has been restarted.

Figure 6-18: RESTART ACKNOWLEDGE message content

6.3.4 Messages for Point-to-multipoint call and connection control

Table 6-4: Messages used with ATM Point-to-multipoint call/connection control

Message	Reference
ADD PARTY	6.3.4.1
ADD PARTY ACKNOWLEDGE	6.3.4.2
PARTY ALERTING	6.3.4.3
ADD PARTY REJECT	6.3.4.4
DROP PARTY	6.3.4.5
DROP PARTY ACKNOWLEDGE	6.3.4.6

6.3.4.1 ADD PARTY

This message is sent to add a party to an existing connection.

Message type: ADD PARTY
 Direction: Preceding to Succeeding
 Significance: Global

Information Element	Reference	Type	Length ³
Protocol discriminator	6.4.2	M	1
Call reference	6.4.3	M	4
Message type	6.4.4.1	M	2
Message length	6.4.4.2	M	2
AAL parameters	6.4.5.8	O(1)	4-21 5-30
Broadband high layer information	6.4.5.11	O(1)	4-13 5-13
Broadband low layer information	6.4.5.12	O(1)	4-17 5-20
Called party number	6.4.5.15	M	(2)
Calling party Soft PVPC or PVCC	6.4.6.1	O(3)	4-10 7-10
Called party Soft PVPC or PVCC	6.4.6.2	O(4)	4-11 8-11
Called party subaddress	6.4.5.16	O(1)	4-25 6-25
Calling party number	6.4.5.17	O(1)	4-26 6-26
Calling party subaddress	6.4.5.18	O(1)	4-25 6-25
Broadband repeat indicator	6.4.5.13	M(5)	5
Designated transit list	6.4.6.4	M(6)	33-546
Endpoint reference	6.4.8.1	M(7)	7
End-to-end transit delay	6.4.5.24	O(1)	4-12 7-12
Generic identifier transport	6.4.5.31	O(1,8)	4-33 7-63
Notification indicator	6.4.5.27	O(1)	4-* 5-*
Transit network selection	6.4.5.30	O(1)	4-8 6-9
<u>User-user³</u>	<u>6.4.5.32</u>	<u>O(1)</u>	<u>6-133</u>

- Note 1 - Included if the received add party [requestindication³](#) contains this information.
- Note 2 - Minimum length depends on the numbering plan. Maximum length is 25 octets.
- Note 3 - Included in case of Soft PVCC setup, when the calling endpoint wants to inform the values used for the PVC segment at the calling end.
- Note 4 - Included in case of Soft PVCC setup.
- Note 5 - Indicates the order of Designated transit list information elements in the DTL stack. This information element is present even when there is only one Designated transit list information element.
- Note 6 - Included by the source node to indicate the hierarchical source route for the party connection. Included by the node at the entry to a hierarchical level to indicate the path through that hierarchical level. This information element may be repeated up to 10 times. [The sum of the lengths of these DTL information elements should be less than or equal to 1400. Note that if the message length exceeds the maximum message length supported by SAAL, the add party request will be rejected.³](#)
- Note 7 - The endpoint reference must be unique within a given call reference on a given link.
- Note 8 - This information element may be present up to 3 times.

Figure 6-19: ADD PARTY message content

6.3.4.2 ADD PARTY ACKNOWLEDGE

This message is sent to acknowledge that the ADD PARTY request was successful.

Message type: ADD PARTY ACKNOWLEDGE
 Direction: Succeeding to Preceding
 Significance: Global

Information Element	Reference	Type	Length ³
Protocol discriminator	6.4.2	M	1
Call reference	6.4.3	M	4
Message type	6.4.4.1	M	2
Message length	6.4.4.2	M	2
Broadband low layer information	6.4.5.12	O(1)	4-17 5-20
AAL parameters	6.4.5.8	O(1)	4-11 5-30
Called party Soft PVPC or PVCC	6.4.6.2	O(1)	4-11 8-11
Connected number	6.4.5.20	O(1)	4-26 6-26
Connected subaddress	6.4.5.21	O(1)	4-25 6-25
Endpoint reference	6.4.8.1	M(2)	7
End-to-end transit delay	6.4.5.24	O(1)	4-7 7
Generic identifier transport	6.4.5.31	O(1,3)	4-33 7-63
Notification indicator	6.4.5.27	O(1)	4-* 5-*
User-user³	6.4.5.32	O(1)	6-133

- Note 1 - Included if the received add party acknowledge [requestindication³](#) contains this information.
- Note 2 - The endpoint reference must be the same value as in the ADD PARTY message being responded to.
- Note 3 - This information element may be present up to 3 times.

Figure 6-20: ADD PARTY ACKNOWLEDGE message content

6.3.4.3 PARTY ALERTING

This message is sent by the succeeding side to indicate that called user alerting has been initiated, if ALERTING is received.

Message Type: PARTY ALERTING
 Direction: Succeeding to Preceding
 Significance: Global

Information Element	Reference	Type	Length ³
Protocol discriminator	6.4.2	M	1
Call reference	6.4.3	M	4
Message type	6.4.4.1	M	2
Message length	6.4.4.2	M	2
Endpoint reference	6.4.8.1	M	7
Notification indicator	6.4.5.27	O(1)	4 * 5 *
Generic identifier transport	6.4.5.31	O(1,2)	4 33 7 - 63
<u>User-user³</u>	<u>6.4.5.32</u>	<u>O(1)</u>	<u>6-133</u>

Note 1 - Included if the received party alerting requestindication³ contains this information.

Note 2 - This information element may be present up to 3 times.

Figure 6-21: PARTY ALERTING message content

6.3.4.4 ADD PARTY REJECT

This message is sent to acknowledge that the ADD PARTY request was not successful.

Message type: ADD PARTY REJECT
 Direction: Succeeding to Preceding
 Significance: Global

Information Element	Reference	Type	Length ³
Protocol discriminator	6.4.2	M	1
Call reference	6.4.3	M	4
Message type	6.4.4.1	M	2
Message length	6.4.4.2	M	2
Cause	6.4.5.19	M	6-34
Crankback	6.4.6.3	O(1)	4 72 7 - 72
Endpoint reference	6.4.8.1	M(2)	7
Generic identifier transport	6.4.5.31	O(3,4)	4 33 7 - 63
<u>User-user³</u>	<u>6.4.5.32</u>	<u>O(3)</u>	<u>6-133</u>

Note 1 - Included to indicate crankback.

Note 2 - The endpoint reference must be the same value as in the ADD PARTY message being responded to.

Note 3 - Included if the received add party reject requestindication³ contains this information.

Note 4 - This information element may be present up to 3 times.

Figure 6-22: ADD PARTY REJECT message content

6.3.4.5 DROP PARTY

This message is sent to drop (clear) a party from an existing point-to-multipoint connection.

Message type: DROP PARTY
 Direction: Both
 Significance: Global

Information Element	Reference	Type	Length ³
Protocol discriminator	6.4.2	M	1
Call reference	6.4.3	M	4
Message type	6.4.4.1	M	2
Message length	6.4.4.2	M	2
Cause	6.4.5.19	M	6-34
Endpoint reference	6.4.8.1	M	7
Notification indicator	6.4.5.27	O(1)	4-5 5-*
Generic identifier transport	6.4.5.31	O(1,2)	4-33 7-63
<u>User-user³</u>	<u>6.4.5.32</u>	<u>O(1)</u>	<u>6-133</u>

- Note 1 - Included if the received drop party requestindication³ contains this information.
 Note 2 - This information element may be present up to 3 times.

Figure 6-23: DROP PARTY message content

6.3.4.6 DROP PARTY ACKNOWLEDGE

This message is sent in response to a DROP PARTY message to indicate that the party was dropped from the connection.

Message type: DROP PARTY ACKNOWLEDGE
 Direction: Both
 Significance: Local

Information Element	Reference	Type	Length ³
Protocol discriminator	6.4.2	M	1
Call reference	6.4.3	M	4
Message type	6.4.4.1	M	2
Message length	6.4.4.2	M	2
Cause	6.4.5.19	O(1)	4-34 6-34
Endpoint reference	6.4.8.1	M	7
<u>User-user³</u>	<u>6.4.5.32</u>	<u>O(2)</u>	<u>6-133</u>

- Note 1 - Mandatory when DROP PARTY ACKNOWLEDGE is sent as a result of an error condition. This information element may appear twice in the message.

Note 2 - Included if the received drop party acknowledge request contains this information.³

Figure 6-24: DROP PARTY ACKNOWLEDGE message content

6.4 General message format and information element coding

The figures and text in this section describe message contents.

6.4.1 Overview

Section 4.1 of Recommendation Q.2931 applies with the following change:

The last sentence of the paragraph immediately below Figure 4-1/Q.2931 does not apply.

6.4.2 Protocol discriminator

Section 4.2 of Recommendation Q.2931 applies with the following changes:

In the first sentence of the first paragraph, replace 'user-network' by 'PNNI'.

The Protocol discriminator is coded as shown in the figure below:

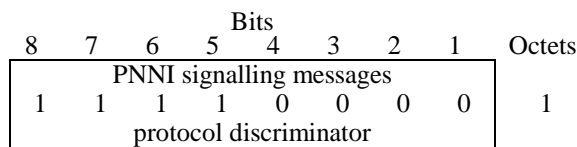

6.4.3 Call reference

Section 4.3 of Recommendation Q.2931 applies with the following change:

In the first sentence of the first paragraph, replace 'user-network interface' by 'PNNI'.

6.4.4 Message type and message length

6.4.4.1 Message type

Section 4.4.1 of Recommendation Q.2931 applies with the following changes:

In Figure 4-6/Q.2931 - message type format Octet 2 bit 4 is changed from "Spare" to "Pass along request". The coding in Table 4-2/Q.2931 (part 2 of 2) is modified as follows:

- Pass along request (Octet 2)	
Bit	
4	
1	Pass along request
0	No pass along request

The following message types are not supported:

CONNECT ACKNOWLEDGE
SETUP ACKNOWLEDGE
INFORMATION

Escape to national specific message types is not supported.

6.4.4.2 Message length

See Section 4.4.2 of Recommendation Q.2931.

6.4.5 Variable length information elements

6.4.5.1 Coding rules³

Section 2 §4.5.1/Q.2931 of ~~UNI 4.0 signalling~~ the UNI Signalling 4.1 specification applies with the following change:

In Figure 4-8/Q.2931 - General information element format Octet 2 bit 4 is changed from “Reserved” to “Pass along request”. The coding in Table 4-3/Q.2931 (part 2 of 2) Octet 2 bit 4 is modified as follows:

- Pass along request (Octet 2)	
Bit	
<u>4</u>	
1	Pass along request
0	No pass along request

The procedures on reception of empty information elements are supported. However, the transmission of empty information elements is not.

The following informative table indicates the maximum length, minimum length, and maximum number of occurrences ~~are specified~~ for each supported information element. For each information element, the “Defined in” column contains references to the section(s) and document(s) where the information element is defined and, when applicable, modified. A complete list of the specifications considered to compile this table is provided in Table 13-2, Annex G, - are given as follows (note: this additional information is presented for clarification only; for ITU defined information elements, the values are consistent with the specifications of Q.2931, Q.2961 and Q.2971)³

For information elements that are optional in a message, the minimum length shown in the table below differs from that in the message section of Q.2931. The message section of Q.2931 allows empty information elements to be sent. Sending of empty information elements is not allowed by this specification, so the following table shows the minimum length for optional information elements not as 4 but as the minimum length for the information element to have valid content, as defined in the sections referenced in the “Defined in” column.³

For some information elements, the maximum length shown in the table differs from the maximum length that can be found in the message tables of Section 6.3. When there is such a discrepancy, the maximum length shown in the table is the maximum length of the information element as modified by the ATM Forum specifications referenced in the “Defined in” column of the table.³

Table 6-5: Information elements used in PNNI

Bits 8 7 6 5 4 3 2 1	Information Element	Max Length	<u>Min</u> <u>Length</u>	Max no. of Occurrences	<u>Defined in</u>
0 0 0 0 0 1 0 0	Narrow-band bearer capability ^(1,2)	14	<u>6</u>	3	<u>§ 6.4.7.1</u>
0 0 0 0 1 0 0 0	Cause ⁽¹⁾	34	<u>6</u>	2	<u>§ 6.4.5.19 and § 3.3 of [13]</u>
0 0 0 1 0 1 0 0	Call state ⁽⁸⁾	<u>5 3008</u>	<u>5</u>	<u>4⁽⁸⁾</u>	<u>§ 6.4.5.14 and § 18.3.2.1</u>
<u>0 0 0 1 1 1 0 0</u>	<u>Facility</u>	<u>(6)</u>	<u>10</u>	<u>(6)</u>	<u>§ 26.8.2.2.2 of [8]</u>
0 0 0 1 1 1 1 0	Progress indicator ⁽¹⁾	6	<u>6</u>	2	<u>§ 6.4.7.4</u>
0 0 1 0 0 1 1 1	Notification indicator	⁽³⁾	<u>5</u>	⁽³⁾	<u>§ 6.4.5.27 and § 26.8.2.2.3 of [8]</u>
0 1 0 0 0 0 1 0	End-to-end transit delay	13	<u>7</u>	1	<u>§ 6.4.5.24</u>
0 1 0 0 1 1 0 0	Connected number	26	<u>6</u>	1	<u>§ 6.4.5.20</u>
0 1 0 0 1 1 0 1	Connected subaddress	25	<u>6</u>	1	<u>§ 6.4.5.21</u>
0 1 0 1 0 1 0 0	Endpoint reference	7	<u>7</u>	1	<u>§ 6.4.8.1</u>
0 1 0 1 0 1 0 1	Endpoint state ⁽⁹⁾	<u>5 3008</u>	<u>5</u>	<u>4⁽⁹⁾</u>	<u>§ 6.4.8.2 and § 18.3.2.2</u>
0 1 0 1 1 0 0 0	ATM adaptation layer parameters	<u>24 30</u>	<u>5</u>	<u>4 2</u>	<u>§ 6.4.5.8</u>

0 1 0 1	1 0 0 1	ATM traffic descriptor	30 <u>36</u>	<u>6</u> ⁽⁵⁾	1	§ 6.4.5.9 and § 2.2.2.2 of [23]
0 1 0 1	1 0 1 0	Connection identifier	9	<u>9</u>	1	§ 6.4.5.22
<u>0 1 0 1</u>	<u>1 0 1 1</u>	<u>OAM traffic descriptor</u>	<u>6</u>	<u>6</u>	<u>1</u>	§ 20.1.2.1
0 1 0 1	1 1 0 0	Quality of service parameter	6	<u>6</u>	1	§ 6.4.5.28
0 1 0 1	1 1 0 1	Broadband high layer information	13	<u>5</u>	1	§ 6.4.5.11
0 1 0 1	1 1 1 0	Broadband bearer capability	7	<u>6</u>	1	§ 6.4.5.10 and § 2.2.2.3 of [23]
0 1 0 1	1 1 1 1	Broadband low-layer information ⁽²⁾	47 <u>20</u>	<u>5</u>	3	§ 6.4.5.12
0 1 1 0	0 0 0 0	Broadband locking shift	5	<u>5</u>	(4)	§ 6.4.5.3
0 1 1 0	0 0 0 1	Broadband non-locking shift	5	<u>5</u>	(4)	§ 6.4.5.4
0 1 1 0	0 0 1 1	Broadband repeat indicator ⁽¹⁾	5	<u>5</u>	3	§ 6.4.5.13
0 1 1 0	1 1 0 0	Calling party number	26	<u>6</u>	1	§ 6.4.5.17
0 1 1 0	1 1 0 1	Calling party subaddress ⁽¹⁾	25	<u>6</u>	2	§ 6.4.5.18
0 1 1 1	0 0 0 0	Called party number	25	<u>6</u>	1	§ 6.4.5.15
0 1 1 1	0 0 0 1	Called party subaddress ⁽¹⁾	25	<u>6</u>	2	§ 6.4.5.16
0 1 1 1	1 0 0 0	Transit network selection	9	<u>6</u>	1	§ 6.4.5.30
0 1 1 1	1 0 0 1	Restart indicator	5	<u>5</u>	1	§ 6.4.5.29
0 1 1 1	1 1 0 0	Narrow-band low layer compatibility ⁽²⁾	20	<u>5</u>	2	§ 6.4.7.3
0 1 1 1	1 1 0 1	Narrow-band high layer compatibility ⁽¹⁾	7	<u>5</u>	2	§ 6.4.7.2
<u>0 1 1 1</u>	<u>1 1 1 0</u>	<u>User-user</u>	<u>133</u>	<u>6</u>	<u>1</u>	§ 6.4.5.32
0 1 1 1	1 1 1 1	Generic identifier transport ⁽¹⁾	33 <u>63</u>	<u>7</u>	3	§ 6.4.5.31
1 0 0 0	0 0 0 1	Minimum acceptable ATM traffic descriptor	20 <u>34</u>	<u>7</u>	1	§ 6.4.5.26 and § 2.2.2.4 of [23]
1 0 0 0	0 0 1 0	Alternate <u>Alternative</u> ATM traffic descriptor	30	<u>12</u>	1	§ 6.4.5.7
1 0 0 0	0 1 0 0	ABR-ATC setup parameters	36	<u>6</u>	1	§ 6.4.5.6
<u>1 0 0 0</u>	<u>1 0 0 1</u>	<u>Broadband report type</u>	<u>5</u>	<u>5</u>	<u>2</u>	§ 6.4.5.33
1 1 1 0	0 0 0 0	Called party Soft PVPC or PVCC	11	<u>8</u>	1	§ 6.4.6.2
1 1 1 0	0 0 0 1	Crankback	72	<u>7</u>	1	§ 6.4.6.3
1 1 1 0	0 0 1 0	Designated transit list ^(2,10)	546	<u>33</u>	10	§ 6.4.6.4
1 1 1 0	0 0 1 1	Calling party Soft PVPC or PVCC	10	<u>7</u>	1	§ 6.4.6.1
1 1 1 0	0 1 0 0	ABR-ATC additional parameters	14	<u>14</u>	1	§ 6.4.5.5
<u>1 1 1 0</u>	<u>0 1 0 1</u>	<u>Generic application transport</u>	<u>512</u>	<u>6</u>	<u>5</u>	§ 3.1 of [16]
<u>1 1 1 0</u>	<u>0 1 1 0</u>	<u>Transported address</u>	<u>53</u>	<u>28</u>	<u>5</u>	§ 3.1 of [11]
<u>1 1 1 0</u>	<u>0 1 1 1</u>	<u>Security services</u>	<u>512</u>	<u>12</u>	<u>1</u>	§ 4 of [12]
1 1 1 0	1 0 1 1	Connection scope selection	6	<u>6</u>	1	§ 6.4.5.23
1 1 1 0	1 1 0 0	Extended QoS parameters	25	<u>7</u>	1	§ 6.4.5.25
<u>1 1 1 0</u>	<u>1 1 1 0</u>	<u>Trace transit list</u>	<u>1466</u> ⁽⁷⁾	<u>38</u>	<u>1</u>	§ 3.1 of [19]
<u>1 1 1 0</u>	<u>1 1 1 1</u>	<u>Network call correlation identifier</u>	<u>38</u>	<u>15</u>	<u>1</u>	§ 2 of [18]
<u>1 1 1 1</u>	<u>0 0 0 0</u>	<u>Minimum desired cell rate</u>	<u>13</u>	<u>13</u>	<u>1</u>	§ 3.1 of [20]
<u>1 1 1 1</u>	<u>0 0 0 1</u>	<u>Optional traffic attributes</u>	<u>14</u>	<u>6</u>	<u>5</u>	§ 2 of [22], and § 5.4 of [25]
<u>1 1 1 1</u>	<u>0 0 1 0</u>	<u>Rerouting services</u>	<u>8</u>	<u>8</u>	<u>1</u>	§ 5.1 of [25]
<u>1 1 1 1</u>	<u>0 0 1 1</u>	<u>Rerouting</u>	<u>80</u>	<u>15</u>	<u>1</u>	§ 5.2 of [25]
<u>1 1 1 1</u>	<u>0 1 0 0</u>	<u>Rerouting cause</u>	<u>5</u>	<u>5</u>	<u>1</u>	§ 5.3 of [25]
<u>1 1 1 1</u>	<u>0 1 0 1</u>	<u>Reference list</u>	<u>3007</u>	<u>6</u>	<u>1</u>	§ 18.3.2.3

- Note 1 - This information element may be repeated without the Broadband repeat indicator information element.
- Note 2 - This information element may be repeated in conjunction with the Broadband repeat indicator information element.
- Note 3 - The maximum length and the number of repetitions of this information element are network dependent.
- Note 4 - See Section 6.5.6.8.1 for details.
- Note 5 - The minimum length for the ATM traffic descriptor information element in the SETUP message is 12. ³
- Note 6 - The maximum length and the maximum number of occurrences of this information element are subject to the message length not exceeding the SSCOP/SSCF payload limit. ³
- Note 7 - A larger maximum length value may be supported as a network specific option. The maximum length should be consistent among all nodes in the network. ³
- Note 8 - When the optional procedures of Annex R are supported the Call state information element may be repeated once for each call state. When the optional procedures of Annex R are not supported, the maximum length for the Call state information element is 5 and the information element may not be repeated. ³
- Note 9 - When the optional procedures of Annex R are supported the Endpoint state information element may be repeated once for each party state. When the optional procedures of Annex R are not supported, the maximum length for the Endpoint state information element is 5 and the information element may not be repeated. ³
- Note 10 - The sum of the lengths of the DTL information elements in a message should be less than or equal to 1400. Note that if the message length exceeds the maximum message length supported by SAAL, the call will be cleared. ³

Coding standard for ISO/IEC standard and national standard are not supported.

Reservation of the value "1111 1111" of the information element identifier is not supported.

In the following sections, where information elements are defined by reference to the UNI Signalling 4.1 specification or ITU-T Recommendation Q.2931 (and applicable amendments), the modifications to octet 2 for the inclusion of the pass along indication shall apply. ³

6.4.5.2 Extension of codesets

See Section 2 §4.5.2/Q.2931 of the UNI Signalling 4.1 UNI 4.0 signalling ³specification.

6.4.5.3 Broadband locking shift procedures

See Section 2 §4.5.3/Q.2931 of the UNI Signalling 4.1 UNI 4.0 signalling ³specification.

6.4.5.4 Broadband non-locking shift procedures

See Section 2 §4.5.4/Q.2931 of the UNI Signalling 4.1 UNI 4.0 signalling ³specification.

6.4.5.5 ATCABR additional parameters

See Section 10.1.2.1 of the UNI Signalling 4.1 UNI 4.0 signalling ³specification.

6.4.5.6 ATCABR setup parameters

See Section 10.1.2.2 of the UNI Signalling 4.1 UNI 4.0 signalling ³specification, with the exception that all octet groups are required.

6.4.5.7 Alternative ATM traffic descriptor

See Section 8.1.2.1 of [the UNI Signalling 4.1 UNI 4.0 signalling³](#) specification.

6.4.5.8 ATM adaptation layer parameters

See Section 2 §4.5.5/Q.2931 of [the UNI Signalling 4.1 UNI 4.0 signalling³](#) specification.

6.4.5.9 ATM traffic descriptor

Section 2 §4.5.6/Q.2931 of [the UNI Signalling 4.1 UNI 4.0 signalling³](#) specification applies with the additions in Section 10.1.2.3 of the [UNI Signalling 4.1 UNI 4.0 signalling³](#) specification and with the following changes:

Tb (tagging backward) (octet 17.1)		
Bit	in CONNECT message (Note 1)	in SETUP message (Note 2)
<u>2</u>		
0	tagging not allowed	tagging not supported
1	tagging requested	tagging supported.

Note 1 - If octet 17.1 is omitted, a default of "tagging not allowed" shall apply.

Note 2 - If octet 17.1 is omitted, a default of "tagging not supported" shall apply.

Tf (tagging forward) (octet 17.1)		
Bit	in SETUP message (Note 3)	in CONNECT message (Note 4)
<u>1</u>		
0	tagging not allowed	tagging not applied
1	tagging requested	tagging applied

Note 3 - If octet 17.1 is omitted, a default of "tagging not allowed" shall apply.

Note 4 - If octet 17.1 is omitted, a default of "tagging not applied" shall apply.

Coding	Meaning ³
Tb = "Tagging not allowed"	<u>Indicates to the preceding side that it shall not apply tagging to user data cell flows in the backward direction for this connection. Backward traffic from the succeeding exchange will already be "tagged"</u>
Tb = "Tagging requested"	<u>Indicates to the preceding side that it shall apply tagging to the user data cell flows in the backward direction for this connection. Backward traffic from the succeeding exchange might not be "tagged" and need only conform to the CLP=0+1 traffic parameters</u>
Tb = "Tagging not supported"	<u>Indicates to the succeeding side that the preceding side does not support tagging of user data cell flows in the backward direction for this connection. Backward traffic from the succeeding exchange must already be "tagged"</u>
Tb = "Tagging supported"	<u>Indicates to the succeeding side that the preceding side supports tagging of user data cell flows in the backward direction for this connection. Preceding exchange will support backward traffic from the succeeding exchange that is not "tagged" and that need only conform to the CLP=0+1 traffic parameters</u>

Tf = "Tagging not allowed"	<u>Indicates to the succeeding side that it shall not apply tagging to user data cell flows in the forward direction for this connection. Forward traffic from the preceding exchange will already be "tagged"</u>
Tf = "Tagging requested"	<u>Indicates to the succeeding side that, if it polices user data cell flows in the forward direction, it should apply tagging to user data cell flows in the forward direction for this connection. Preceding exchange requesting permission to send forward traffic to the succeeding exchange that is not "tagged" and that need only conform to the CLP=0+1 traffic parameters</u>
Tf = "Tagging not applied"	<u>Indicates to the preceding side that the succeeding side does not apply tagging to user data cell flows in the forward direction for this connection. Forward traffic from the preceding exchange must already be "tagged"</u>
Tf = "Tagging applied"	<u>Indicates to the preceding side that the succeeding side applies tagging to user data cell flows in the forward direction for this connection. Succeeding exchange will allow forward traffic to the succeeding exchange that is not "tagged" and that need only conform to the CLP=0+1 traffic parameters</u>

6.4.5.10 Broadband bearer capability

See Section 2 §4.5.7/Q.2931 of the UNI Signalling 4.1 UNI 4.0 Signalling³ specification applies with the following change:-

- Replace the text of Note E with the following:

These ATC values are allowed for the PNNI (e.g. if these values are received in a setup request, a PNNI node may relay them).

6.4.5.11 Broadband high layer information

See Section 2 §4.5.8/Q.2931 of the UNI Signalling 4.1 UNI 4.0 signalling³ specification.

6.4.5.12 Broadband low layer information

See Section 2 §4.5.9/Q.2931 of the UNI Signalling 4.1 UNI 4.0 signalling³ specification.

6.4.5.13 Broadband repeat indicator

See Section 4.5.19 of Recommendation Q.2931 with the following changes in octet 5.

Broadband repeat indication (octet 5)

Bits				Meaning
4	3	2	1	
0	0	1	0	Prioritized list for selecting one possibility
1	0	1	0	Last-in, First out stack (Note)

Note - The last appearance of the repeated information element is interpreted as the top (last entered) element of the stack. The second-to-last, third-to-last etc. occurrences of the repeated information element shall be interpreted as the second, third etc. entries on the stack.

6.4.5.14 Call state

The purpose of the Call state information element is to describe the current status of a call at the PNNI or a global interface state.

8	7	6	5	4	3	2	1	Octet
Call state								
0	0	0	1	0	1	0	0	1
Information element identifier								
1 ext	Coding standard		IE Instruction field					2
Length of the call state contents								3
Length of the call state contents (continued)								4
0	0	PNNI call state value / global interface state value					5	
Spare								

Figure 6-25: Call state information element

PNNI call state value (octet 5) (Note)

Bits						Meaning
6	5	4	3	2	1	
0	0	0	0	0	0	NN0 - Null
0	0	0	0	0	1	NN1 - Call initiated
0	0	0	0	1	1	NN3 - Call proceeding sent
0	0	0	1	0	0	NN4 - Alerting delivered
0	0	0	1	1	0	NN6 - Call present
0	0	0	1	1	1	NN7 - Alerting received
0	0	1	0	0	1	NN9 - Call proceeding received
0	0	1	0	1	0	NN10 - Active
0	0	1	0	1	1	NN11 - Release request
0	0	1	1	0	0	NN12 - Release indication

Note - PNNI call state values are coded using coding standard "1 1" ATM Forum specific.

Global interface state value (octet 5)

Bits						Meaning
6	5	4	3	2	1	
0	0	0	0	0	0	REST 0 = Null
1	1	1	1	0	1	REST 1 = Restart request
1	1	1	1	1	0	REST 2 = Restart

6.4.5.15 Called party number

See Section 2 §4.5.11/Q.2931 of [the UNI Signalling 4.1 UNI 4.0 signalling³](#) specification.

6.4.5.16 Called party subaddress

See Section 2 §4.5.12/Q.2931 of [the UNI Signalling 4.1 UNI 4.0 signalling³](#) specification.

6.4.5.17 Calling party number

See Section 2 §4.5.13/Q.2931 of [the UNI Signalling 4.1 UNI 4.0 signalling³](#) specification.

6.4.5.18 Calling party subaddress

See Section 2 §4.5.14/Q.2931 of [the UNI Signalling 4.1 UNI 4.0 signalling³](#) specification.

6.4.5.19 Cause

See Section 2 §4.5.15/Q.2931 of [the UNI Signalling 4.1 UNI 4.0 signalling](#) specification. In addition the following [PNNI-ATM Forum³](#) specific cause values, using coding standard 1 1, are applicable:

Bits 7 6 5 4 3 2 1	Number	Meaning	Diagnostics
0 1 1 0 1 0 1	53	Call cleared due to change in PGL	
0 1 0 0 0 1 0	34	Requested called party Soft PVPC or PVCC not available	

6.4.5.20 Connected number

See Annex 4 section A4.5 of the [UNI Signalling 4.1 UNI 4.0 signalling³](#) specification.

6.4.5.21 Connected subaddress

See Annex 4 section A4.5 of the [UNI Signalling 4.1 UNI 4.0 signalling³](#) specification.

6.4.5.22 Connection identifier

Section 2 §4.5.16/Q.2931 of [the UNI Signalling 4.1 UNI 4.0 signalling³](#) specification applies with the following change:

Associated signalling is supported.

6.4.5.23 Connection scope selection

See Section [7.2.2.17.1.3.1¹](#) of [the UNI Signalling 4.1 UNI 4.0 signalling³](#) specification.

6.4.5.24 End-to-end transit delay

The purpose of the End-to-end transit delay information element is to indicate the forward maximum cell transfer delay acceptable on a per call basis and to indicate the cumulative forward maximum cell transfer delay to be expected for a connection. Note that the cumulative backward maximum cell transfer delay can be derived from the cumulative forward maximum cell transfer delay and the cumulative forward and backward cell delay variation.

The maximum cell transfer delay of user data transferred during the data transfer phase on the user plane is defined in Section 3.6.1 of the Traffic Management [4.1-4.0³](#) Specification.

The End-to-end transit delay is coded as shown in Figure 6-26 of this specification.

The maximum length of this information element is 13 octets.

8	7	6	5	4	3	2	1	Octet
End-to-end transit delay information element identifier								1
0	1	0	0	0	0	1	0	
1 ext	Coding standard	IE Instruction field						2
Length of the End-to-end transit delay contents								3
Length of the End-to-end transit delay contents (continued)								4
0	0	0	0	0	0	0	1	5*
Cumulative Forward Maximum Cell Transfer Delay Identifier								(Note 2)
Cumulative Forward Maximum Cell Transfer Delay								5.1*
Cumulative Forward Maximum Cell Transfer Delay (continued)								5.2*
0	0	0	0	1	0	1	1	6*
PNNI Acceptable Forward Maximum Cell Transfer Delay Identifier								
PNNI Acceptable Forward Maximum Cell Transfer Delay								6.1*
PNNI Acceptable Forward Maximum Cell Transfer Delay (continued)								6.2*
PNNI Acceptable Forward Maximum Cell Transfer Delay (continued)								6.3*
0	0	0	1	0	0	0	1	7*
PNNI Cumulative Forward Maximum Cell Transfer Delay Identifier								(Note 2)
PNNI Cumulative Forward Maximum Cell Transfer Delay								7.1*
PNNI Cumulative Forward Maximum Cell Transfer Delay (continued)								7.2*
PNNI Cumulative Forward Maximum Cell Transfer Delay (continued)								7.3*
0	0	0	0	1	0	1	0	8* (Note 1)
Network generated indicator								

- Note 1 - Included if and only if the origin of this information element is other than the originating user.
 Note 2 - Octet groups 5 and 7 are mutually exclusive. Octet group 5 is used in the CONNECT and ADD PARTY ACKNOWLEDGE messages and octet group 7 is used in the SETUP and ADD PARTY messages.

Figure 6-26: End-to-end transit delay information element

Coding standard (octet 2)

Bits	Meaning
7 6	
1 1	ATM Forum specific

Cumulative Forward Maximum Cell Transfer Delay (octets 5.1-5.2)

The cumulative forward maximum cell transfer delay value is expressed in units of milliseconds. It is coded as a 16-bit binary integer, with Bit 8 of the first octet being the most significant bit and Bit 1 of the second octet being the least significant bit.

PNNI Acceptable Forward Maximum Cell Transfer Delay (octets 6.1-6.3)

The PNNI acceptable forward maximum cell transfer delay parameter indicates the calling user's highest acceptable (least desired) maximum cell transfer delay value, expressed in units of microseconds. It is coded as a 24-bit binary integer, with Bit 8 of the first octet being the most significant bit and Bit 1 of the third octet being the least significant bit. The value "1111 1111 1111 1111 1111 1111", however, is not to be interpreted as an acceptable maximum cell transfer delay value. This codepoint indicates: 'any forward maximum cell transfer delay value acceptable'.

PNNI Cumulative Forward Maximum Cell Transfer Delay (octets 7.1-7.3)

The PNNI cumulative forward maximum cell transfer delay value is expressed in units of microseconds. It is coded as a 24-bit binary integer, with Bit 8 of the first octet being the most significant bit and Bit 1 of the third octet being the least significant bit.

Network generated indicator (octet 8)

If this subfield is not present, then the origin of this information element is the originating user (so the called party can assume that the received cumulative values are end-to-end values). Otherwise, the presence of this subfield indicates the origin of this information element is other than the originating user

6.4.5.25 Extended QoS parameters

See Section 9.1.2.2 of [the UNI Signalling 4.1 UNI 4.0 signalling³](#) specification.

6.4.5.26 Minimum acceptable ATM traffic descriptor

See Section 8.1.2.2 of [the UNI Signalling 4.1 UNI 4.0 signalling³](#) specification.

6.4.5.27 Notification indicator

See [Annex 7, section A7.1.2.1 of the UNI 4.0 signalling specification, and¹](#) section 4.5.23 of Recommendation Q.2931.

6.4.5.28 Quality of service parameter

See Section 2 §4.5.18/Q.2931 of [the UNI Signalling 4.1 UNI 4.0 signalling³](#) specification.

6.4.5.29 Restart indicator

See Section 2 §4.5.20/Q.2931 of [the UNI Signalling 4.1 UNI 4.0 signalling³](#) specification.

6.4.5.30 Transit network selection

See Section 2 §4.5.22/Q.2931 of [the UNI Signalling 4.1 UNI 4.0 signalling³](#) specification.

6.4.5.31 Generic identifier transport

See Section 2.1.1 of the [UNI Signalling 4.1 UNI 4.0 signalling³](#) specification.

6.4.5.32 User-user³

[See Section A4.8 of the UNI Signalling 4.1 specification.](#)

6.4.5.33 Broadband report type³

[Section 2 §4.5.25/Q.2931 of the UNI Signalling 4.1 specification shall apply with the following changes:](#)

- [Replace the first addition with the following paragraph:](#)

[Switching systems supporting the Broadband report type information element in the SETUP message shall also implement the CONNECTION AVAILABLE message defined in Section 6.3.1.10.](#)

6.4.6 Information elements ~~specific to~~ defined for³ PNNI

6.4.6.1 Calling party Soft PVPC or PVCC

The purpose of the Calling party Soft PVPC or PVCC information element is to indicate the VPCI or VPCI/VCI values used for the PVC segment by the calling connecting point. In case of a frame relay calling connecting point, this information element indicates the DLCI value used⁴. These values are conveyed to the called connecting point transparently.

8	7	6	5	4	3	2	1	Octet	
Calling party Soft PVPC or PVCC									
1	1	1	0	0	0	1	1	1	
Information element identifier									
1 ext	Coding standard		IE Instruction Field					2	
Length of calling party Soft PVPC or PVCC contents								3	
Length of calling party Soft PVPC or PVCC contents (continued)								4	
1	0	0	0	0	0	0	1	5* <u>(Note 5)</u>	
VPCI identifier									
VPCI value								5.1*	
VPCI value								5.2*	
1	0	0	0	0	0	1	0	6* <u>(Note 1,5)</u>	
VCI identifier									
VCI value								6.1*	
VCI value								6.2*	
1	0	0	0	0	0	1	1	7* <u>(Note 1,2,5)</u>	
DLCI Identifier									
0 Ext	0 Spare	DLCI (Most significant 6 bits)							7.1*
0/1 Ext	DLCI (2 nd most significant 4 bits)			0	0	Spare		7.2*	
1 Ext	DLCI (3 rd most significant 6 bits)					0 Resrv Spare ³		7.3* <u>(Note 3)</u>	
0 Ext	DLCI (3 rd most significant 7 bits)								7.3* <u>(Note 4)</u>
1 Ext	DLCI (4 th most significant 6 bits)					0 Resrv Spare ³		7.4* <u>(Note 4)</u>	

- Note 1 - This octet group is only present in case of a Soft PVCC.
- Note 2 - The DLCI is 2 or 3 or 4 octets (i.e. 10 or 16 or 23 bits respectively). The standard default length of the DLCI is two octets. The extension bit mechanism is used to indicate non-default length and thus to determine the total length of the DLCI.
- Note 3 - This octet shall only be included when bilateral agreements between the nodes which are endpoints of the Soft PVC allow a 3-octet DLCI (16 bits).
- Note 4 - These octets shall both be included only when bilateral agreements between the nodes which are endpoints of the Soft PVC allow a 4-octet DLCI (23 bits).
- Note 5 - When octet group 7 is present neither octet group 5 nor octet group 6 may be present.⁴

Figure 6-27: Calling party Soft PVPC or PVCC Information element

Coding standard (octet 2)

Bits	Meaning
7 6	
1 1	ATM Forum specific

VPCI value (octets 5.1 and 5.2)

A two octet binary number assigned to the ATM connection representing the identifier of the Virtual Path Connection Identifier. The VPCI value is meaningful to the originating destination³ node and can have any two octet value, coded in the low order 12 bits and the high order 4 bits (octet 5.1 bits 8 to 5) are coded to all zero.⁴

When the calling party number identifies an interface that is not a cell relay or frame relay interface, the VPCI is a virtual identifier whose semantics are local to and are defined within the context of the calling party number. In such cases, this field is not an actual VPCI.³

VCI value (octet 6.1 and 6.2)

A two octet binary number assigned to the ATM connection representing the identifier of the Virtual Channel Connection.

When the calling party number identifies an interface that is not a cell relay or frame relay interface, the VCI is a virtual identifier whose semantics are local to and are defined within the context of the calling party number. In such cases, this field is not an actual VCI.³

6.4.6.2 Called party Soft PVPC or PVCC

The purpose of the Called party Soft PVPC or PVCC information element is to indicate the VPCI or VPCI/VCI values of a PVC segment between the called connecting point and the user of a PVPC or PVCC respectively. In case of a frame relay called connecting point, this information element indicates the DLCI value used.⁴ These values are conveyed to the called connecting point transparently.

8	7	6	5	4	3	2	1	Octet	
Called party Soft PVPC or PVCC									
1	1	1	0	0	0	0	0	1	
Information element identifier									
1 ext	Coding Standard		IE Instruction Field					2	
Length of called party Soft PVPC or PVCC contents								3	
Length of called party Soft PVPC or PVCC contents (continued)								4	
Selection type								5	
1	0	0	0	0	0	0	1	6* (Note 1)	
VPCI identifier									
VPCI value								6.1*	
								6.2*	
1	0	0	0	0	0	1	0	7* (Note 1,2)	
VCI identifier									
VCI value								7.1*	
								7.2*	
<u>1</u>	<u>0</u>	<u>0</u>	<u>0</u>	<u>0</u>	<u>0</u>	<u>1</u>	<u>1</u>	<u>8* (Note 1,2,3)</u>	
<u>DLCI Identifier</u>									
<u>0</u> <u>Ext</u>	<u>0</u> <u>Spare</u>	<u>DLCI</u> <u>(Most significant 6 bits)</u>							<u>8.1*</u>
<u>0/1</u> <u>Ext</u>	<u>DLCI</u> <u>(2nd most significant 4 bits)</u>			<u>0</u>	<u>0</u>	<u>0</u>			<u>8.2*</u>
<u>1</u> <u>Ext</u>	<u>DLCI</u> <u>(3rd most significant 6 bits)</u>					<u>0</u> <u>Resrv</u> <u>Spare³</u>		<u>8.3* (Note 4)</u>	
<u>0</u> <u>Ext</u>	<u>DLCI</u> <u>(3rd most significant 7 bits)</u>							<u>8.3* (Note 5)</u>	
<u>1</u> <u>Ext</u>	<u>DLCI</u> <u>(4th most significant 6 bits)</u>					<u>0</u> <u>Resrv</u> <u>Spare³</u>		<u>8.4* (Note 5)</u>	

- Note 1 - This octet group is not included when the selection type indicates “any value”. If present, it shall be ignored. When the selection type is coded as “required value” or “assigned value”, either octet group 6-7 (ATM endpoint) or 8 (frame relay endpoint) may be included but not both.⁴
- Note 2 - This octet group is only present in case of a Soft PVCC.
- Note 3 - The DLCI is 2 or 3 or 4 octets (i.e. 10 or 16 or 23 bits respectively). The standard default length of the DLCI is two octets. The extension bit mechanism is used to indicate non-default length and thus to determine the total length of the DLCI.
- Note 4 - This octet shall only be included when bilateral agreements between the nodes which are endpoints of the Soft PVC allow a 3-octet DLCI (16 bits).
- Note 5 - These octets shall both be included only when bilateral agreements between the nodes which are endpoints of the Soft PVC allow a 4-octet DLCI (23 bits).⁴

Figure 6-28: Called party Soft PVPC or PVCC Information element

Coding standard (octet 2)

Bits	Meaning
7 6	
1 1	ATM Forum specific

Selection type (octet 5)

Bits	Meaning
8 7 6 5 4 3 2 1	
0 0 0 0 0 0 0 0	Any value
0 0 0 0 0 0 1 0	Required value
0 0 0 0 0 1 0 0	Assigned value

VPCI value (octets 6.1 and 6.2)

A two octet binary number assigned to the ATM connection representing the identifier of the Virtual Path Connection Identifier. The VPCI value is meaningful to the destination node and can have any two octet value, coded in the low order 12 bits and the high order 4 bits (octet 6.1 bits 8 to 5) are coded to all zero.⁴ When the called party number identifies an interface that is not a cell relay or frame relay interface, the VPCI is a virtual identifier whose semantics are local to and are defined within the context of the called party number. In such cases, this field is not an actual VPCI.³

VCI value (octet 7.1 and 7.2)

A two octet binary number assigned to the ATM connection representing the identifier of the Virtual Channel Connection. When the called party number identifies an interface that is not a cell relay or frame relay interface, the VCI is a virtual identifier whose semantics are local to and are defined within the context of the called party number. In such cases, this field is not an actual VCI.³

6.4.6.3 Crankback

The purpose of the Crankback information element is to indicate that crankback procedures have been initiated. It also indicates the node or link where the call/connection or party cannot be accepted, and the level of PNNI hierarchy at which crankback is being carried out.

8	7	6	5	4	3	2	1	Octet
Crankback								
1	1	1	0	0	0	0	1	1
Information element identifier								
1 ext	Coding Standard		IE Instruction Field					2
Length of crankback contents								3
Length of crankback contents (continued)								4
Crankback level								5
Blocked transit type								6
Blocked transit identifier (format and length dependent on value of blocked transit type)								6.1 etc
Crankback cause								7 (Note)
Crankback cause diagnostics (if any)								7.1* etc.

Note - The crankback cause in addition to the Cause information element identifies the cause for crankback.

Figure 6-29: Crankback Information element

Coding standard (octet 2)

Bits	Meaning
7 6	
1 1	ATM Forum specific

Crankback level (octet 5)

The Crankback level indicates the level of PNNI hierarchy at which the call/connection or party is being cranked back. The crankback level coded in binary, with a length of 1 octet.

Blocked transit type (octet 6)

Bits	Meaning	Length of blocked transit identifier
8 7 6 5 4 3 2 1		
0 0 0 0 0 0 1 0	call or party has been blocked at the succeeding end of this interface	0
0 0 0 0 0 0 1 1	blocked node	22
0 0 0 0 0 1 0 0	blocked link	48

Blocked transit identifier (octet 6.1 etc)

The blocked transit identifier format depends on the blocked transit type.

For Blocked transit type = “blocked node identifier”

Blocked node identifier	6.1 to 6.22
-------------------------	----------------

Blocked node identifier (octets 6.1 to 6.22)

The Blocked node identifier identifies the logical node at which the call/connection or party has been blocked. It is coded in binary, with a length of 22 octets. Section 5.3.3 describes the abstract syntax of logical node identifiers.

For Blocked transit type = “blocked link identifier”

Blocked link’s preceding node identifier	6.1 to 6.22
Blocked link’s port identifier	6.23 to 6.26
Blocked link’s succeeding node identifier	6.27 to 6.48

Blocked link’s preceding node identifier (octets 6.1 to 6.22)

The Blocked link’s preceding node identifier identifies the logical node preceding a link at which the call/connection or party has been blocked. It is coded in binary, with a length of 22 octets. Section 5.3.3 describes the syntax of logical node identifiers.

Blocked link’s port identifier (octet 6.23 to 6.26)

The Blocked link’s port identifier identifies a logical port of the blocked link’s preceding node identifier. The combination of the blocked link’s preceding node identifier and the blocked link’s port identifier unambiguously (but not uniquely) identifies the link at which the call/connection or party has been blocked. A port identifier of 0 indicates that all links from the blocked link’s preceding node to the blocked link’s succeeding node should be considered blocked. The logical port identifier is coded in binary, with a length of 4 octets. Section 5.3.4 describes the syntax of logical port identifiers.

Blocked link’s succeeding node identifier (octets 6.27 to 6.48)

The Blocked link’s succeeding node identifier identifies the logical node succeeding a link at which the call/connection or party has been blocked. It is coded in binary, with a length of 22 octets. Section 5.3.3 describes the syntax of logical node identifiers.

Crankback cause (octet 7)

Bits 8 7 6 5 4 3 2 1	Number	Meaning	Diagnostics
0 0 0 0 0 0 1 0	2	transit network unreachable	
0 0 0 0 0 0 1 1	3	Destination unreachable	
0 0 1 0 0 0 0 0	32	too many pending add party requests	
0 0 1 0 0 0 1 1	35	Requested VPCI/VCI not available	
0 0 1 0 0 1 0 1	37	user cell rate not available	Note 1
0 0 1 0 0 1 1 0	38	network out of order	
0 0 1 0 1 0 0 1	41	Temporary failure	
0 0 1 0 1 1 0 1	45	no VPCI/VCI available	
0 0 1 0 1 1 1 1	47	resource unavailable, unspecified	
0 0 1 1 0 0 0 1	49	Quality of Service unavailable	Note 2
0 0 1 1 1 0 0 1	57	bearer capability not authorized	
0 0 1 1 1 0 1 0	58	bearer capability not presently available	
0 0 1 1 1 1 1 1	63	service or option not available, unspecified	
0 1 0 0 0 0 0 1	65	bearer service not implemented	
0 1 0 0 1 0 0 1	73	Unsupported combination of traffic parameters	
1 0 0 0 0 0 0 0	128	next node unreachable	
<u>1 0 0 0 0 0 0 1</u>	<u>129</u>	<u>Node is a restricted transit node³</u>	
1 0 1 0 0 0 0 0	160	DTL Transit not my node ID	

Crankback cause diagnostics (Octet 7.1 etc.)

The use of crankback cause diagnostics and the coding format of the diagnostics varies among the different cause values. The diagnostics column of the table above indicates whether diagnostics are applicable and the coding format of the diagnostics field.

Note 1 - Updated topology state parameters for generic connection admission control can optionally be included in the crankback cause diagnostics. Refer to Annex B Section 8.4 for further details. These topology state parameters can be used instead of the most recent GCAC parameters received for the blocked node or link. They are superseded when the next set of topology state parameters are received, either in PTSEs or in other call clearing messages. If AvCR, CRM, and VF are included, then complex GCAC applies (see Section 5.13.4.2). If only AvCR is specified, then simple GCAC applies (see Section 5.13.4.3). Only updated topology state parameters for one direction can be included using the following coding:

8	7	6	5	4	3	2	1	Octet
Direction								7.1*
Port Identifier								7.2* to 7.5*
AvCR								7.6* to 7.9*
CRM								7.10* to 7.13*
VF								7.14* to 7.17*

Direction (octet 7.1)

Bits								Meaning
8	7	6	5	4	3	2	1	
0	0	0	0	0	0	0	0	Forward
0	0	0	0	0	0	0	1	Backward

Port Identifier (octets 7.2 to 7.5)

The port identifier at the preceding node of the link to which the updated topology state parameters apply. Note that this port ID is determined by the preceding node of a blocked link. If the blocked transit is a node or when sent by the succeeding side of a blocked link, the port identifier is set to zero.

If the Direction (octet 7.1) is Forward, then the updated topology state parameters apply to the outgoing direction of this port from the blocked link's preceding node. If the direction is backward and the blocked link is a horizontal link, then the updated topology state parameters apply to the outgoing direction of the corresponding port on the blocked link's succeeding node. If the direction is backward and the blocked link is an uplink, then the updated topology state parameters apply to the incoming direction of this port on the blocked link's preceding node.

Note 2 - The following coding is used:

8	7	6	5	4	3	2	1	Octet			
Spare							CTD	CDV	CLR	Other QoS	7.1

CTD (octet 7.1)

Bits	Meaning
4	
0	CTD available
1	CTD unavailable

CDV (octet 7.1)

Bits	Meaning
3	
0	CDV available
1	CDV unavailable

CLR (octet 7.1)

Bits	Meaning
2	
0	CLR available
1	CLR unavailable

Other QoS parameters (octet 7.1)

Bits	Meaning
1	
0	Other QoS parameters available
1	Other QoS parameters unavailable

6.4.6.4 Designated transit list

The purpose of the designated transit list is to indicate the logical nodes and logical links that a connection is to traverse through a peer group at some level of hierarchy. Annex A describes the procedures for constructing designated transit list.

8	7	6	5	4	3	2	1	Octet
Designated transit list								
1	1	1	0	0	0	1	0	1
Information element identifier								
1 ext	Coding standard		IE Instruction Field					2
Length of designated transit list contents								3
Length of designated transit list contents (continued)								4
Current transit pointer								5
Current transit pointer (continued)								6
0	0	0	0	0	0	0	1	7 (Note 3)
Logical node / logical port indicator								
Logical node identifier								7.1 to 7.22
Logical port identifier								7.23 to 7.26

Note 1 - The designated transit list is an ordered list. Interpretation of octet groups within the Designated transit list information element is position dependent.

Note 2 - The designated transit list information element must be structured in a way such that each transit is capable of advancing the current transit pointer from itself to the next node in the list.

Note 3 - Octet group 7 (in its entirety) may appear as many as 20 times.

Figure 6-30: Designated transit list information element

Coding standard (octet 2)

Bits	Meaning
7 6	
1 1	ATM Forum specific

Current transit pointer (octets 5 and 6)

The current transit pointer is encoded as an octet offset pointer to the transit node/logical port which indicates the current call/connection's progress along the designated transit list. When a node receives a DTL, this pointer points to the ID of this node or of an ancestor of this node. It is encoded as a 16 bit unsigned integer. The value 0 indicates the first transit that appears in the information element (i.e., the node that generated the information element), the value 27 indicates the second transit (i.e., the nearest neighbor of the node that generated the information element), the value 54 indicates the third transit, and so on.

Logical node identifier (octets 7.1 to 7.22)

The logical node identifier uniquely identifies a logical node (i.e., a real switching system or a peer group at some level of hierarchy) which the call/connection is to transit. It is coded in binary, with a length of 22 octets. Section 5.3.3 describes the abstract syntax and semantics of logical node identifiers.

Logical Port Identifier (octet 7.23 to 7.26)

The logical port identifier uniquely identifies a logical port of the logical node which the call/connection is to transit. The combination of Logical Node Identifier and Logical Port Identifier unambiguously (but not uniquely) identifies a logical link. The logical port identifier is coded in binary, with a length of 4 octets. The value 00000000 (hexadecimal) is reserved to indicate no logical port identified (i.e., this transit only identifies a logical node). Section 5.3.4 describes the abstract syntax and semantics of logical port identifiers.

6.4.7 Information Elements for the support of 64 kbit/s based circuit mode services

The information elements described in this section are transported transparently through the PNNI except where explicitly addressed by procedures.

6.4.7.1 Narrow-band bearer capability

See Section 4.6.2 of Recommendation Q.2931.

6.4.7.2 Narrow-band high layer compatibility

See Section 4.6.3 of Recommendation Q.2931.

6.4.7.3 Narrow-band low layer compatibility

See Section 4.6.4 of Recommendation Q.2931.

6.4.7.4 Progress indicator

See Section 4.6.5 of Recommendation Q.2931.

6.4.8 Information Elements for Point-to-Multipoint Call/connection Control

6.4.8.1 Endpoint reference

See Section 8.2.1 of ITU-T Recommendation Q.2971.

6.4.8.2 Endpoint state

See Section 8.2.2 of ITU-T Recommendation Q.2971.

6.5 Call/connection control procedures for ATM point-to-point calls

This section describes procedures for point-to-point calls only. Section 6.6 contains additional procedures for point-to-multipoint calls as well as changes to the point-to-point procedures needed to support point-to-multipoint calls.

Procedures based on ATM Forum User-to-Network Interface (UNI) and ITU-T Recommendation Q.2931 are used to establish ATM switched virtual connections. The signalling virtual channel uses VPI=0,VCI=5 in case of non-associated signalling. In case of associated signalling, VCI=5 is used as the signalling channel in the VPC.

This specification allows for optional support of point-to-point switched virtual paths ~~connections~~ (SVPCs). Except where noted, the references to switched virtual ~~channels-connections~~ (SVCs) apply equally to SVPCs.³

6.5.1 Establishment of a signalling AAL

Before these procedures are invoked, an assured mode signalling AAL connection must be established between the two private network nodes. All layer 3 messages shall be sent to the signalling AAL using an AAL-DATA-REQUEST primitive. For more information on the Signalling ATM Adaptation layer (SAAL) Specification, see Section 4.0 of [the UNI Signalling 4.1 UNI 4.0 Signalling](#)³ specification.

Note: The service primitives used by Q.2931 entities to request and accept services from the SAAL are described in Annex A/Q.2931.

6.5.2 Call/connection establishment

6.5.2.1 Call/connection request

Call establishment shall be initiated by the preceding side by sending a SETUP message. The preceding side shall start timer T303 and enter the Call Present state. The message shall always contain a call reference, selected according to the procedures given in §6.4.3. This message is sent only if resources for the call are available; otherwise, the call is cleared towards the calling user.

The SETUP message shall contain all the information required to process the call. In particular, the called party address information is contained in the Called party number information element possibly supplemented by the Called party subaddress information element. The ATM traffic descriptor, ~~and~~ Broadband bearer capability, ~~and~~ ~~Quality of service parameter~~ information elements are mandatory in the SETUP message. At least one of the Quality of service parameter or Extended QoS parameters information elements must be present. If the Quality of service parameter information element is not present, this means that no interworking with UNI3.0/3.1 or ITU-T protocols is desired.³

When the SETUP message contains an ATM group address in the called party number information element, this indicates that the call shall be progressed to one of the members of the group within the connection scope indicated in the Connection scope selection information element (i.e., this call uses the ATM Anycast capability). In this case, if no Connection scope selection information element is included in the SETUP message, the node shall assume a default Connection scope selection of localNetwork(1).

If no response to the SETUP message is received by the preceding side before the first expiration of timer T303, the SETUP message may be retransmitted and timer T303 restarted.

If the preceding side does not receive any response to the SETUP after the final expiration of timer T303, the preceding side shall enter the Null state and send a RELEASE COMPLETE message to the succeeding side with cause #102, "recovery on timer expiry" and initiate clearing (without crankback) towards the calling party with cause #102, "recovery on timer expiry". Call control shall be notified of the failure of the call.

On receipt of the SETUP message the succeeding side shall enter the Call Initiated state.

6.5.2.2 Connection identifier allocation/selection

Two cases exist:

i) Associated Signalling:

The layer 3 signalling entity exclusively controls the VCs in the VPC which carries its signalling VC.

ii) Non-Associated Signalling:

The layer 3 signalling entity controls the VCs in the VPC which carries its signalling VC and may control VCs in other VPCs.

In PNNI, the virtual channel with VPI=0/VCI=5 is the only virtual channel used for non-associated signalling. This signalling channel does not control virtual channels within VPCs configured for use with associated signalling, but does control all the remaining virtual channels and virtual paths on the physical link.

The PNNI interface shall support the non-associated signalling procedures and may as an option support the associated signalling procedures. The associated signalling procedures are used only when two PNNI network nodes are connected by a virtual path connection used as a logical link.

When a network node receives a connection identifier information element with the VP-associated signalling field (see §6.4.5.22) coded with a value not supported by this network node, the call shall be rejected with cause #36, "VPCI/VCI assignment failure".

6.5.2.2.1 Associated signalling

For associated signalling, the preceding side requests a virtual channel in the VPC carrying the signalling VC. The VPC carrying the signalling VC is implicitly indicated.

In the Connection identifier information element, the VP associated signalling field is coded as "VP associated signalling" in the Connection identifier information element and one of the following values is indicated in the Preferred/exclusive field:

- a) Exclusive VPCI; any VCI; or,
- b) Exclusive VPCI; exclusive VCI.

In case a), the succeeding side selects any available VCI within the VPC carrying the signalling VC.

In case b), if the indicated VCI within the VPC carrying the signalling VC is available, the succeeding side selects it for the call.

The selected VCI value is indicated in the Connection identifier information element in the first message returned by the succeeding side in response to the SETUP message (i.e., CALL PROCEEDING message). The VP associated signalling field is coded as "VP associated signalling". The Preferred/exclusive field is coded as "Exclusive VPCI; exclusive VCI".

In case a), if no VCI is available, a RELEASE COMPLETE message with cause #45, "no VPCI/VCI available", is sent by the succeeding side. In addition, a Crankback information element is included with crankback cause #45.

In case b), if the indicated VCI is not available, a RELEASE COMPLETE message with the cause #35, "requested VPCI/VCI not available", is sent by the succeeding side. In addition, a Crankback information element is included with crankback cause #35.

Call collision can occur when both sides of an interface simultaneously transfer SETUP messages indicating the same exclusive VPCI and VCI. For PNNI interfaces, in order to avoid call collision, the side which has the higher node identifier (see Section 5.3.3) shall allocate the connection identifier (VPCI, VCI) values. The node identifiers used for this comparison shall be the lowest-level node identifiers used on each side of the interface. These node identifiers are the ones indicated in the Node ID field (octets 11 to 32) in PNNI Hellos transmitted and received over the same interface.³ A preceding side which has a higher node identifier shall include a Connection identifier information element in the SETUP message with option (b) (exclusive VPCI and exclusive VCI). A SETUP message from a preceding side which has a lower node identifier shall use option (a).

6.5.2.2.2 Non-associated signalling

6.5.2.2.2.1 Allocation for switched virtual channels

When the preceding side requests a virtual channel in the SETUP message, the preceding side shall indicate one of the following:

- a) Exclusive VPCI; any VCI;
- b) Exclusive VPCI; exclusive VCI; or,
- c) No indication is included (i.e., the Connection identifier information element is not included in the SETUP message).

In cases a) and b), the VP associated signalling field is coded as "explicit indication of VPCI" in the Connection identifier information element.

In cases a) and b), if the indicated VPCI is available, the succeeding side selects it for the call. In case a), the succeeding side selects any available VCI in the VPCI. In case b), if the indicated VCI is available within the VPCI, the succeeding side selects it for the call.

In case c), the succeeding side selects any available VPCI and VCI.

The selected VPCI/VCI value is indicated in the Connection identifier information element in the first message returned by the succeeding side in response to the SETUP message (i.e., CALL PROCEEDING message). The VP associated signalling field is coded as "explicit indication of VPCI". The Preferred/exclusive field is coded as "exclusive VPCI; exclusive VCI".

In cases a) and b), if the specified VPCI is not available, a RELEASE COMPLETE message with cause #35, "requested VPCI/VCI not available", is sent by the succeeding side. In addition, a Crankback information element is included with crankback cause #35.

In case a), if no VCI is available, a RELEASE COMPLETE message with cause #45, "no VPCI/VCI available", is sent by the succeeding side. In addition, a Crankback information element is included with crankback cause #45.

In case b), if the VCI in the indicated VPCI is not available, a RELEASE COMPLETE message with cause #35, "requested VPCI/VCI not available", is sent by the succeeding side. In addition, a Crankback information element is included with crankback cause #35.

In case c), if the succeeding side is not able to allocate a VCI in any VPCI, a RELEASE COMPLETE message with cause #45, "no VPCI/VCI available", is sent by the succeeding side. In addition, a Crankback information element is included with crankback cause #45.

Call collision can occur when both sides of an interface simultaneously transfer SETUP messages indicating the same exclusive VPCI and VCI. For PNNI interfaces, in order to avoid call collision, the side which has the higher node identifier (see Section 5.3.3) shall allocate the connection identifier (VPCI, VCI) values. The node identifiers used for this comparison shall be the lowest-level node identifiers used on each side of the interface. These node identifiers are the ones indicated in the Node ID field (octets 11 to 32) in PNNI Hellos transmitted and received over the same interface.³ A preceding side which has a higher node identifier shall include a Connection identifier information element in the SETUP message with option (b) (exclusive VPCI and exclusive VCI). A SETUP message from a preceding side which has a lower node identifier shall use options (a) or (c).

6.5.2.2.2 Allocation for switched virtual paths

When the establishment of a switched virtual path [connection \(SVP C\)](#)³ is requested (i.e., the Bearer class field of the Broadband bearer capability information element in the SETUP message indicates “VP service“), the preceding side shall indicate one of the following:

- c) No indication is included (i.e., the connection identifier IE is not included in the SETUP message)
- d) Exclusive VPCI; no VCI

In case (c), the succeeding side selects any available VPCI.

In case (d), if the indicated VPCI is available, the succeeding side selects it for the call. The selected VPCI is indicated in the Connection identifier information element in the first message returned by the succeeding side in response to the SETUP message (i.e., CALL PROCEEDING). The VP associated signalling field is coded as “explicit indication of VPCI”. The preferred/exclusive field is coded as “exclusive VPCI; no VCI”.

In case (c), if the succeeding side is not able to allocate a VPCI, a RELEASE COMPLETE message with cause #45 “No VPCI/VCI available” is sent by the succeeding side. In addition, a Crankback information element is included with crankback cause #45.

In case (d), if the indicated VPCI is not available, a RELEASE COMPLETE message with cause #35 “Requested VPCI/VCI not available” is sent by the succeeding side. In addition, a Crankback information element is included with crankback cause #35.

Call collision can occur when both sides of an interface simultaneously transfer SETUP message indicating the same exclusive VPCI. For PNNI interfaces, in order to avoid call collision, the side which has the higher node identifier (see Section 5.3.3) shall allocate the connection identifier (VPCI) values. [The node identifiers used for this comparison shall be the lowest-level node identifiers used on each side of the interface. These node identifiers are the ones indicated in the Node ID field \(octets 11 to 32\) in PNNI Hellos transmitted and received over the same interface.](#)³ A preceding side which has a higher node identifier shall include a Connection identifier information element in the SETUP message with option (d) (exclusive VPCI and no VCI). A SETUP message from a preceding side which has a lower node identifier shall use option (c).

6.5.2.2.3 Use of VPCIs

The Connection identifier information element is used in signalling messages to identify the corresponding user information flow. The Connection identifier information element contains the Virtual Path Connection Identifier (VPCI) and the Virtual Channel Identifier (VCI). The VPCI is used instead of the Virtual Path Identifier (VPI) since Virtual Path Cross Connects may be used and multiple interfaces could be controlled by the signalling virtual channel.

Both the preceding side and the succeeding side must understand the relationship between the VPCI used in the signalling protocol and the actual VPI used for the user information flow. VPCIs only have significance with regard to a given signalling virtual channel.

For this Implementation Agreement, each non-associated signalling virtual channel only controls a single interface at the PNNI, and the VPCI and VPI have the same numerical value.

6.5.2.2.4 VPCI and VCI ranges

The range of valid VCI values is indicated below:

0-31	Not used for on-demand user plane connections
32-65535	Identifier of the Virtual Channel (Note)

Note - Some values in the range may not be available for use (e.g., some values may be used for permanent connections). The upper bound on the VCI range (i.e., 65535) may be further restricted by the number of active VCI bits. In addition, a need might arise to reserve more than 32 VCI values.

The range of valid VPCI values is as indicated below:

0-4095	Identifier of the Virtual Path (Note)
--------	---------------------------------------

Note - Some values in the range may not be available for use (e.g., some values may be used for permanent virtual path connections). The upper bound on the VPCI range (i.e., 4095) may be further restricted by the number of active VPI bits.

6.5.2.3 Service category, traffic parameter, and QoS selection procedures

6.5.2.3.1 Determination of service category

See Annex 9 §A9.2 of [the UNI Signalling 4.1 UNI 4.0 signalling](#)³ specification.

In addition, if the network node determines that the requested service category is not available, it shall initiate crankback in accordance with §6.5.3.3 and Annex B, with one of the following cause and crankback cause codes.

#57	<i>bearer capability not authorized;</i>
#58	<i>bearer capability not presently available;</i>
#65	<i>bearer service not implemented.</i>

6.5.2.3.2 Allowed combination of bearer capabilities, traffic parameters, and QoS

Annex 9 §A9.3 of [the UNI Signalling 4.1 UNI 4.0 signalling](#)³ specification applies with the following ~~addition~~modifications:

- Replace the second paragraph by the following text:³

~~If the succeeding side detects that the Broadband bearer capability, ATM traffic descriptor, End to end transit delay, and Extended QoS parameters information elements contain a non supported set of parameters, the succeeding side shall return a RELEASE COMPLETE message with cause #73 "Unsupported combination of traffic parameters". If the combination of Traffic parameters, QoS parameters and QoS class in a SETUP message is not a combination allowed for the ATM Service Category, the call shall be cleared with Cause #73, "Unsupported combination of traffic parameters".~~ In addition, a Crankback information element is included with crankback cause #73 "Unsupported combination of traffic parameters".

- Occurrences of Note 6 in Table A9-2 shall be replaced with "S".³

6.5.2.3.3 Traffic parameter selection procedures during the call/connection establishment request³

If the succeeding side is not able to provide the indicated ATM traffic parameters, the succeeding side shall crankback the call, returning a RELEASE COMPLETE message with cause and crankback cause #37, "user cell rate unavailable".

~~If the received setup indication specifies a Tf field coded to "Tagging requested" then the preceding side:
— may set the Tf field coded as "Tagging requested" in the transmitted SETUP message, if this node does not perform tagging for this connection
— shall specify a Tf indication of "Tagging not allowed" in the transmitted SETUP message, if this node does perform tagging for this connection~~

~~If the received setup indication specified a Tf indication of “Tagging not allowed”, the preceding side shall specify a Tf indication of “Tagging not allowed” in the transmitted SETUP message.~~

~~If the received setup indication specifies a Tb indication of “Tagging not supported” then the preceding side:~~
~~—shall specify a Tb indication of “Tagging not supported” in the transmitted SETUP message, if this node will not perform tagging for this connection~~
~~—may set the Tb field coded as “Tagging supported” in the transmitted SETUP message, if this node can perform tagging for this connection~~

~~If the received setup indication specified a Tb field coded “Tagging supported”, the preceding side may send a Tb field coded “Tagging supported” in the transmitted SETUP message. (This indicates to the succeeding side that the capability of supporting tagging exists for backward traffic, and that the preceding side is willing to accept untagged traffic.)~~

~~The succeeding side may include the Tf field coded to “Tagging requested” in the SETUP message when the incoming call request contained such an indication. The succeeding side may include the Tb field coded to “Tagging supported” in the SETUP message when there are CLP=0 traffic parameters in the ATM traffic descriptor information element.~~

~~If the preceding side, as a result of local policy, chooses to request tagging in the forward direction to the succeeding side, then it shall set the Tf field of the ATM traffic descriptor information element to “tagging requested” in the SETUP message forwarded to the succeeding side. Otherwise, the preceding side shall set the Tf field to “tagging not allowed” in the SETUP message forwarded to the succeeding side.~~

~~If the preceding side polices user data cell flows in the backward direction for this connection, and it chooses to indicate support for tagging in the backward direction for this connection, then the preceding side shall set the Tb field to “tagging supported” in the SETUP message forwarded to the succeeding side. Otherwise, the preceding side shall set the Tb field to “tagging not supported” in the forwarded SETUP message.~~³

When a SETUP message with an indication of frame discard is received, the PNNI node follows the procedures described in Section 2.2.1 of [the UNI Signalling 4.1 UNI 4.0 signalling](#)³ specification.

6.5.2.3.4 Procedures for negotiation of traffic parameters during call/connection setup

When both the Minimum acceptable ATM traffic descriptor and the Alternative ATM traffic descriptor information elements are present in a SETUP message, a network node shall reject the connection establishment request as specified in 6.5.3 with cause #73, "Unsupported combination of traffic parameters" (without crankback). If the parameters of the Alternative ATM traffic descriptor information element or Minimum acceptable ATM traffic descriptor information element are not according to the allowed combinations as specified in Sections 6.4.5.7 and ~~6.4.5.26 6.4.5.2.6~~ respectively, the network shall handle these information elements as if they were non-mandatory information elements with content error as specified in ~~Section 6.5.6.8-5.6.8/Q.2931~~³.

~~The Alternative ATM traffic descriptor information element does not apply to UBR calls. If an Alternative ATM traffic descriptor information element is received in a SETUP message for a UBR call, it shall be ignored.~~³

~~For a UBR call, if the Minimum acceptable ATM traffic descriptor information element is present, a network node should negotiate the Forward and/or Backward Peak Cell Rate parameters downwards to reflect its bandwidth limitation for this call.~~³

When the Minimum acceptable ATM traffic descriptor is included in the SETUP message and a network node is able to provide the traffic parameter values specified in the ATM traffic descriptor information element, the network node shall progress the connection establishment request with both the ATM traffic descriptor information element and the Minimum acceptable ATM traffic descriptor element.

When the Minimum acceptable ATM traffic descriptor is included in the SETUP message and a network node is not able to provide some of the [traffic parameter values eell-rates](#) indicated in the ATM traffic descriptor information element, but is able to provide at least their corresponding [values eell-rates](#) in the Minimum acceptable ATM traffic descriptor information element, the network node shall progress the connection establishment request after adjusting the [traffic parameter values eell-rates](#) with reduced values at or above those specified in the Minimum acceptable ATM traffic descriptor information element. If some of the parameters [values](#) in the Minimum acceptable ATM traffic descriptor information element are still less than the corresponding parameters [values](#) in the modified ATM traffic descriptor information element then the call shall be progressed with the Minimum acceptable ATM traffic descriptor information element containing only such parameters [values](#)³ in addition to the modified ATM traffic descriptor information element. Otherwise, the call shall progress with the modified ATM traffic descriptor information element and without the Minimum acceptable ATM traffic descriptor information element.

When the Alternative ATM traffic descriptor information element is included in the SETUP message and the network node is able to provide the traffic parameter values specified in the ATM traffic descriptor information element and the network node is able to provide the traffic parameter values specified in the Alternative ATM traffic descriptor information element, the network node shall progress the connection establishment request with both the ATM traffic descriptor information element and the Alternative ATM traffic descriptor information element.

When the Alternative ATM traffic descriptor information element is included in the SETUP message and a network node is able to provide the traffic parameter values specified in the ATM traffic descriptor information element, but is not able to provide the traffic parameter values specified in the Alternative ATM traffic descriptor information element, the network node shall progress the connection establishment request with the ATM traffic descriptor information element and without the Alternative ATM traffic descriptor information element.

When the Alternative ATM traffic descriptor information element is included in the SETUP message and a network node is not able to provide the traffic parameter values specified in the ATM traffic descriptor information element, but is able to provide the traffic parameter values specified in the Alternative ATM traffic descriptor information element, the network node shall progress the connection establishment request by using the contents of the Alternative ATM traffic descriptor information element as the ATM traffic descriptor and no Alternative ATM traffic descriptor information element shall be forwarded.

If a network node cannot support the traffic parameter values specified in the ATM traffic descriptor information element and cannot support the traffic parameter values in the Alternative ATM traffic descriptor information element or Minimum acceptable ATM traffic descriptor information element as appropriate, the network node shall reject the connection establishment request as specified in 6.5.3 with cause #37 "User cell rate unavailable". In addition, a Crankback information element with the corresponding crankback cause code shall be included.

6.5.2.3.5 QoS parameter selection procedures

QoS requirements are expressed inside PNNI networks through the values of individual quality of service parameters, which are included in the Extended QoS parameters information element and/or the End-to-end transit delay information element. The allowed set of individual QoS parameters in the SETUP message is determined by the ATM service category of the call.

For each individual QoS parameter, if an acceptable value of a parameter is included and the end-to-end value of that parameter is determined by accumulation, then the corresponding cumulative value of the parameter shall also be included. The cumulative forward and backward values of individual QoS parameters sent in the SETUP message are updated sequentially along the route of the call to determine the values to be expected for this call. The procedures specified in this section support the simple method for accumulation (i.e., additive) of delay parameters described in the ATM Forum Traffic Management [4.1-4.0](#)³ specification.

When the preceding side receives a setup [requestindication](#)³ that includes a QoS parameter information element, the preceding side shall include a QoS parameters information element in the corresponding SETUP message.

When the preceding side receives a setup [requestindication³](#) from a previous interface that is not a PNNI interface, the ATM service category of the call is CBR, real-time VBR, or non-real-time VBR, and no Extended QoS parameters information element is contained in the received SETUP message, the preceding side shall generate an Extended QoS parameters information element, using a local mapping from the service category and the forward and backward QoS class fields in the QoS parameter information element. In addition, an End-to-end transit delay information element may be generated as part of the above mapping, if it was not contained in the received setup [requestindication³](#). When such a mapping is used, all individual QoS parameters for which values are implied (from the QoS classes included in the QoS parameters information element and the ATM service category of the call) must be specified, and the origin of each information element including one or more of the newly generated individual QoS parameters must be marked as an 'intermediate network' (i.e., in the Extended QoS parameters information element the Origin field is set to 'intermediate network', and in the End-to-end transit delay information element a 'network-generated indicator' is included). All cumulative parameter values generated from the mapping must be initialized to zero before beginning processing of the individual QoS parameters.

For each parameter contained in the Extended QoS parameters information element and/or the End-to-end transit delay information element, the preceding side shall take the following actions (whether the information element was contained in the received SETUP message or whether the information element was generated using a local mapping from the QoS class):

1. If the previous interface was not a PNNI interface and the parameter is cumulative:
 - a) the preceding side shall increment the cumulative forward value of the parameter to account for expected increases due to user data transfer over the previous link, from the network boundary to this switching system.
 - b) In addition, the preceding side shall increment the cumulative backward value of the parameter to account for expected increases due to user data transfer over the previous link, from this switching system to the network boundary, and also to account for expected increases due to user data transfer within this switching system.

Note that the procedures described in this step are not necessarily associated with this PNNI interface; they may also be considered as procedures undertaken at the succeeding side of the previous (non-PNNI) interface. They are provided here in order to complete specification of the steps required to support the network side procedures in the [UNI Signalling 4.1 UNI 4.0 Signalling³](#) specification.

2. The preceding side shall increment the forward cumulative value of the parameter, if the parameter is cumulative, to account for the expected increases due to user data transfer within this switching system and over the link from this switching system to the switching system at the succeeding side.
3. The preceding side shall determine if the highest/lowest acceptable values of that parameter can be supported. If no values {less than/greater than} or equal to the highest/lowest acceptable value can be supported, then the preceding side shall follow the crankback procedures specified in Annex B [§section 8.3.1.1 and¹](#) 8.3.1.2, using cause and crankback cause No. 49, "Quality of service unavailable".

If no acceptable forward value of an allowed individual QoS parameter for the corresponding ATM service category is specified (in the Extended QoS Parameters or End-to-end transit delay information elements), then the default is that any value of the individual QoS parameter is acceptable and the preceding side shall continue to process the call.

If the preceding side is able to provide the acceptable values of all specified individual QoS parameters, the preceding side shall progress the call to the succeeding side.

The succeeding side does not make use of the QoS parameter information element, but passes it on if it is present and if the call is progressed.

For each parameter contained in the Extended QoS parameters information element and/or the End-to-end transit delay information element, the succeeding side shall:

1. Increment the backward cumulative value of the parameter, if the parameter is cumulative, to account for the expected increases due to user data transfer within this switching system and over the link from this switching system to the switching system at the preceding side.
2. If the next interface over which the call is to be routed is not a PNNI interface and the parameter is cumulative
 - a) the succeeding network node shall increment the cumulative forward value of that parameter to account for the expected increases due to user data transfer within this switching system and over the following link, between this switching system and the network boundary.
 - b) In addition, increment the cumulative backward value to account for the expected increases due to user data transfer over the following link, from the network boundary to this switching system.

Note that the procedures described in this step are not necessarily associated with this PNNI interface; they may also be considered as procedures undertaken at the preceding side of the next (non-PNNI) interface. They are provided here in order to complete specification of the steps required to support the network side procedures in the [UNI Signalling 4.1 UNI 4.0 Signalling](#)³ specification.

The result of performing the accumulation procedures described above is that the network determines the cumulative forward and backward parameters measured from network boundary to network boundary. Note that this applies even in the case where the path for the call does not traverse any PNNI interfaces at all.

3. Determine if the highest/lowest acceptable values of that parameter can be supported. If no values {less than/greater than} or equal to the highest/lowest acceptable value can be supported, then the succeeding side shall follow the crankback procedures specified in Annex B [section 8.3 8.3.1.1 and 8.3.1.3](#)¹, returning a RELEASE or RELEASE COMPLETE message (depending on whether or not a CALL PROCEEDING message has been sent yet) with cause and, if applicable, crankback cause #49, "Quality of service unavailable".

If no acceptable ~~forward-backward~~¹ value of an allowed individual QoS parameter for the corresponding ATM service category is specified (in the Extended QoS Parameters or End-to-end transit delay information elements), then the default is that any value of the individual QoS parameter is acceptable and the succeeding side shall continue to process the call.

If the succeeding side is able to provide the acceptable values of all specified individual QoS parameters, the succeeding side shall continue to progress the call.

6.5.2.3.6 Traffic parameter selection procedures for ABR connections

In the case of ABR connections, the following additional and modified procedures apply for the processing of traffic parameters.

Parameter defaulting for ABR parameters as defined in the ATM Forum [UNI Signalling 4.1 UNI 4.0 signalling](#) specification shall be performed at the network side of the calling user UNI. [If the ATM traffic descriptor information element contains a non-zero PCR \(CLP=0+1\) parameter for a given \(forward or backward\) direction, the ABR parameters for that direction in the ATC setup parameters information element are all mandatory in the SETUP message. The ABR parameters for a given \(forward or backward\) direction in the ATC setup parameters information element are not included in the SETUP message if the ATM traffic descriptor information element contains a zero PCR \(CLP=0+1\) parameter for that direction](#)³. In the case of Soft PVPC or PVCC setup, the originating switching system is responsible for sending a SETUP message with all these parameters present.

The negotiation procedures allow each switching system to adjust the parameters of a call as needed to protect the resources in that switching system and the quality of service commitments made to other connections. The resources in question are not necessarily associated with a particular PNNI; they may relate to a UNI, or be common to several interfaces.

Since the algorithms in this chapter describe the PNNI, negotiation is modeled as occurring at the PNNI (at both the preceding and succeeding sides). It should be understood that this is not meant to constrain the switching system. In particular, for the first and last switching system in the call path, the resources related to the calling user UNI and called user UNI, respectively, are considered in the negotiation process.

- Negotiation of parameters in the ATM traffic descriptor and ~~ABR-ATC~~³ setup parameters information elements:

Parameter values for a given direction for PCR, ICR, TBE, RIF, and RDF can be negotiated by either side. MCR can be negotiated using the procedures in Section 6.5.2.3.4 if the corresponding MCR parameter is included in the Minimum acceptable ATM traffic descriptor information element in the SETUP message.

If able to provide the indicated PCR, ~~ICR, TBE, RIF, and RDF~~ and ~~ABR-setup~~ parameter values, the PNNI network shall progress the call towards the called user, with the original ~~values of these~~³ parameters.

If unable to provide the indicated PCR, but able to provide at least the MCR value as negotiated, the PNNI network shall progress the call towards the called user, after adjusting the PCR value. The adjusted PCR value ~~will-shall~~³ be greater than or equal to MCR value.

When progressing the call, the network may, if necessary, also adjust either or both “forward” and “backward” ~~parameters: ABR-ATC~~ setup parameters: ~~ICR, TBE, RIF and RDF.ABR initial cell rate, ABR transient buffer exposure, Rate increase factor and rate decrease factor.~~³

The following table summarizes the modifications that may be made:

Parameter for a given direction	Modification by the network
PCR	Decrease only
ICR	Decrease only
TBE	Decrease only
RIF	Decrease only; <u>note 2</u> ²
RDF	<u>Notes 1, 2</u> Increase only ²

Note 1: The value of RDF may be increased or decreased, subject to the constraint that the ratio RDF / RIF shall not be decreased. (Hence, if RIF is decreased by a factor k , RDF may be decreased by at most a factor k , or it may be increased.)²

Note 2: The values chosen by a node must obey the above rules, and they need to be chosen in such a way that any combination of the values of these parameters that subsequent nodes are allowed to select according to the negotiation rules will be acceptable to the node.²

Parameter negotiation maintains the following invariant:

$$\text{MCR} \leq \text{ICR} \leq \text{PCR}$$

If the network is not able to provide the peak cell rates which are equal to MCR, then the crankback procedures in Annex B, §8.3 shall be followed, with cause and crankback cause #37, “User cell rate not available”.

- Negotiation of parameters in the ~~ATM-ABR¹-ATC~~³ additional parameters information element:

Parameter values for ~~ATM-ABR¹~~ parameters in the ~~ATC~~ additional parameters ~~information element~~ can be negotiated by either side, but only when the parameter is present in the SETUP message (i.e., was supplied by the calling user). If the parameter is absent, the default value applies, and no negotiation is possible for the parameter in this case. If the ~~ATM-ABR¹-ATC~~ additional parameters information element is not included in the SETUP message, then the default values apply to all the above parameters and none are negotiable. The default values for additional parameters are specified in the Traffic Management specification 4.1-4.0³.

The ATM Forum Traffic Management specification [4.1-4.0³](#), provides further detail on considerations relating to negotiation. The following table summarizes the modifications that may be made:

Parameter for a given direction	Modification by the network
Nrm	No negotiation (Note)
Trm	No negotiation (Note)
CDF	Increase only
ADTF	Decrease only

Note - If the network does not support the indicated value, it can change to default by changing the indicator present bit.

The parameter is negotiable up to its fixed bound specified for its encoding.

6.5.2.3.7 Processing of Cumulative RM fixed round-trip time parameter for ABR connections

The succeeding side shall adjust the cumulative RM fixed round-trip time parameter in the ~~ABR-ATC³~~ setup parameters information element. The amount of the adjustment is the sum of the forward and reverse direction fixed portion of the RM cell delay on the PNNI, including the forward and reverse link propagation delays and any fixed processing delays at the PNNI and within the switching system. The adjustment value, expressed in microseconds encoded as an integer, is added to the cumulative RM fixed round-trip time parameter.

In the first and last switching systems of the call path, the network side of the UNI shall adjust the cumulative RM fixed round-trip time parameter in the ~~ABR-ATC³~~ setup parameters information element. The amount of the adjustment is the sum of the forward and reverse direction fixed portion of the RM cell delay on the UNI, including the forward and reverse link propagation delays upto network boundary and any fixed processing delays at the UNI and within the switching system.

The effect of the above rules is that at each switching system the Cumulative ABR RM Fixed Round Trip Time parameter is adjusted by the round trip time contribution of the previous hop, whether that hop was a UNI or PNNI. The final switching system is an exception: it includes both the previous hop and the next hop (to the called user) in its adjustment.

Note that the Cumulative ABR RM Fixed Round Trip Time parameter is adjusted only in SETUP message processing, not in CONNECT message processing.

6.5.2.4 Call/connection proceeding

The succeeding side shall send a CALL PROCEEDING message to the preceding side to acknowledge the SETUP message and to indicate that the call is being processed; and enter the Call Proceeding Sent state. When the preceding side receives the CALL PROCEEDING message, the preceding side shall stop timer T303, start timer T310, and enter the Call Proceeding Received state.

Note: Sending of the CALL PROCEEDING message is mandatory.

If, following the receipt of a SETUP message, the succeeding side determines that for some reason the call cannot be supported, then the succeeding side shall initiate call clearing as defined in §6.5.3. ~~Some of the causes that may be used are given in §6.5.2.10.~~³

If the preceding side has received a CALL PROCEEDING message, but does not receive a CONNECT, ALERTING, or RELEASE message prior to the expiration of timer T310, then the preceding side shall: initiate clearing procedures (without crankback) towards the originating interface with cause #102, "recovery on timer expiry" and clears towards the called party with cause #102, "recovery on timer expiry".

6.5.2.5 Call/connection alerting

Upon receiving an indication that the called party is alerting, the succeeding side shall send an ALERTING message to the preceding side and enter the Alerting Delivered state.

When the preceding side receives an ALERTING message from the succeeding side, it shall stop timer T310; start T301; enter the Alerting Received state and send an alerting indication towards the calling user.

6.5.2.6 Call/connection connected

Upon receiving an indication from Call Control that the call has been accepted, the succeeding side shall: send a CONNECT message to the preceding side and enter the Active state.

This message indicates to the preceding side that a connection has been established from this interface to the called party.

On receipt of the CONNECT message, the preceding side shall: stop timer T310 or T301 and enter the Active state.

6.5.2.6.1 Procedures for traffic parameter selection during call/connection acceptance

If the received ~~CONNECT message~~connect request contained an ATM traffic descriptor information element, the succeeding side shall forward the ATM traffic descriptor information element as it received it, with the possible exception of the Tf and Tb fields.

~~If the SETUP message contained an ATM traffic descriptor information element with the Tf parameter coded to "Tagging requested" then the succeeding exchange shall indicate in the CONNECT message: "Tagging applied", if this node performs tagging for this connection, or the same tagging value as the incoming connect indication, if this node does not perform tagging for this connection.~~

~~If the SETUP message contained an ATM traffic descriptor information element with the Tf parameter coded to "Tagging not allowed" then the succeeding exchange shall indicate in the CONNECT message "Tagging not applied".~~

~~If:~~

~~the preceding side sent a SETUP message containing an ATM traffic descriptor information element with the Tf field coded to "Tagging requested", and
the preceding side receives a CONNECT message containing an ATM traffic descriptor information element with the Tf field indicating "Tagging not applied",
then the resources allocated to the connection for forward traffic may be modified, since forward traffic must conform to CLP=0 traffic parameters as well as CLP=0+1 traffic parameters.~~

~~If the SETUP message contained an ATM traffic descriptor information element with the Tb parameter coded to "Tagging supported" then the succeeding exchange shall indicate in the CONNECT message:
—"Tagging not allowed" if this node performs tagging for this connection, or
—the same tagging value as the incoming connect indication, if this node does not perform tagging for this connection.~~

~~If:~~

~~—the preceding side sent a SETUP message containing an ATM traffic descriptor information element with the Tb field coded to "Tagging supported", and
—the preceding side receives a CONNECT message containing an ATM traffic descriptor information element with the Tb field indicating "Tagging not allowed",
then the resources allocated to the connection for backward traffic may be modified, since backward traffic must conform to CLP=0 traffic parameters as well as CLP=0+1 traffic parameters.~~

If the succeeding side polices user data cell flows in the forward direction, then:

- If the succeeding side had received a SETUP message containing an ATM traffic descriptor information element with the Tf field coded to “tagging requested”, and the succeeding side chooses to perform tagging for this connection, it shall set the Tf field to “tagging applied” in the CONNECT message forwarded to the preceding side.
- Otherwise the succeeding side shall not apply tagging to the user data cell flows in the forward direction for this connection, and it shall set the Tf field to “tagging not applied” in the CONNECT message forwarded to the preceding side.

If the succeeding side does not police user data cell flows in the forward direction, the succeeding side shall set the Tf field to “tagging not applied” in the CONNECT message forwarded to the preceding side.

If the Tb field in the SETUP message received by the succeeding side was set to “tagging supported” and, as a result of local policy, the succeeding side chooses to request tagging in the backward direction, then it shall set the Tb field to “tagging requested” in the CONNECT message forwarded to the preceding side. Otherwise, the succeeding side shall set the Tb field to “tagging not allowed” in the CONNECT message forwarded to the preceding side.

If the preceding side polices user data cell flows in the backward direction, then:

- If the preceding side receives a CONNECT message with the Tb field set to “tagging requested” and it had set the Tb field to “tagging supported” in the SETUP message it sent, then the preceding side shall apply tagging in the backward direction.
- Otherwise, the preceding side shall not apply tagging in the backward direction.³

When a CONNECT message with an indication of frame discard is received, the PNNI node follows the procedures described in Section 2.2.1 of the UNI Signalling 4.1 UNI 4.0 signalling³ specification.

6.5.2.6.2 Procedures for negotiation of traffic parameters during call/connection acceptance

If a peer returns the ATM traffic descriptor information element in the CONNECT message, the network node shall forward the ATM traffic descriptor information element as it received it. If the traffic parameter values in the CONNECT message differ from those that the node has forwarded in the SETUP message, the resources that the node has allocated to the connection shall be modified accordingly. The node shall not clear a call due to ~~due to a valid combination of values of the~~ the values of the RIF and RDF parameters received in the CONNECT message if these values conform to – (See notes 1 and 2 in Section 6.5.2.3.6.)^{2,3}

If a peer returns no ATM traffic descriptor information element in the CONNECT message and the network node has negotiated the traffic parameters when it processed the corresponding SETUP message, the node shall include the ATM traffic descriptor information element in the CONNECT message before forwarding it. The contents of the ATM traffic descriptor shall be the same as in the forwarded SETUP message, with the exception of the Traffic Management Options which shall be coded as specified in Section ~~6.5.2.6.2~~ 6.5.2.6.1³.

If a peer returns no ATM traffic descriptor in the CONNECT message and the network node has not negotiated the traffic parameters when it processed the corresponding SETUP message, the node can optionally include the ATM traffic descriptor information element in the CONNECT message. The contents of the ATM traffic descriptor shall be the same as in the forwarded SETUP message, with the exception of the Traffic Management Options which shall be coded as specified in Section ~~6.5.2.6.2~~ 6.5.2.6.1³.

6.5.2.7 Failure of call establishment

In addition to the procedures described in Section 6.5.2.3, the following shall apply. If the succeeding side determines that the requested service is not available or is not able to progress the call, the succeeding side shall initiate crankback in accordance with §6.5.3.3 and Annex B, with one of the following cause and crankback cause codes.

- #38 *network out of order;*
- #41 *temporary failure;*
- #58 *bearer capability not presently available;*
- #63 *service or option not available, unspecified; or,*
- #65 *bearer service not implemented.*

This list is not exhaustive.

6.5.2.8 Generic identifier transport procedures

See Section 2.2.2 of the [UNI Signalling 4.1](#) ~~UNI 4.0 signalling~~³ specification.

6.5.3 Call/connection clearing

In case of crankback, additional procedures to these Call/connection clearing procedures are described in Annex B.

6.5.3.1 Terminology

See Section 5.4.1 of ITU-T Recommendation Q.2931.

6.5.3.2 Exception conditions

Under normal conditions, call clearing shall be initiated at the UNI. At the PNNI, call clearing may be initiated by either side of PNNI as a response to a call clearing request initiated at a UNI or due to a failure, administrative action, or other exception condition. The clearing procedures are defined in §6.5.3.3. The exception to the above rule is as follows:

The succeeding side can reject a call/connection after receiving a SETUP message by: responding with a RELEASE COMPLETE message provided no other response has previously been sent; releasing the call reference, and entering the Null state.

6.5.3.3 Clearing

Apart from the exceptions identified in §6.5.3.2, the clearing procedures are symmetrical and may be initiated by either the preceding or succeeding side of the PNNI. In the interest of clarity, the following procedures describe only the case where preceding side initiates clearing.

The preceding side shall initiate clearing by: sending a RELEASE message, starting timer T308; release the virtual channel and entering the Release Request state.

The succeeding side of the PNNI interface shall enter the Release Indication state upon receipt of a RELEASE message. On receipt of this message, the succeeding side shall release the virtual channel, and initiate procedures for clearing the network connection by informing the PNNI Call control entity. Once the virtual channel used for the call has been released, the succeeding side shall: send a RELEASE COMPLETE message to the preceding side; release both the call reference and virtual channel (i.e. Connection identifier); and enter the Null state.

Note - The RELEASE COMPLETE message has only local significance and does not imply an acknowledgement of end-to-end clearing.

On receipt of the RELEASE COMPLETE message the preceding side shall: stop timer T308; release the virtual channel; release the call reference and return to the Null state.

If timer T308 expires for the first time, the preceding side shall: retransmit a RELEASE message to the succeeding side with the cause number originally contained in the first RELEASE message; restart timer T308 and remain in the Release Request state. In addition, the preceding side may indicate a second Cause information element with cause #102, "recovery on timer expiry". If no RELEASE COMPLETE message is received from the succeeding side before timer T308 expires a second time, the preceding side shall: release the call reference; and return to the Null state. Additional recovery procedures, such as initiating restart, are implementation dependent.

6.5.3.4 Clear collision

Clear collision can occur when both sides simultaneously transfer a RELEASE message related to the same call reference value. If the preceding or succeeding side receives a RELEASE message while in the Release Request state, the receiving entity shall: stop timer T308; release the call reference and virtual channel; and enter the Null state (without sending or receiving a RELEASE COMPLETE message).

6.5.4 Call/connection collisions

Call/connection collision can occur when both sides of the PNNI interface simultaneously transfer SETUP messages indicating traffic parameters which together exceed the remaining resources on the interface. Both sides of the PNNI interface shall clear the call/connection according to the procedures of 6.5.3 with a Crankback information element. The cause and crankback cause used shall be:

- #47 *resources unavailable, unspecified;*
- #49 *quality of service unavailable; or*
- #51 *user cell rate not available.*

6.5.5 Restart Procedures

Section 2 §5.5/Q.2931 of [the UNI Signalling 4.1 UNI 4.0 signalling³](#) specification shall apply with the following changes:

Replace the first paragraph with the following text:

Both sides of the PNNI interface shall implement these procedures.

6.5.5.1 Sending RESTART

Section 2 §5.5.1/Q.2931 of [the UNI Signalling 4.1 UNI 4.0 signalling³](#) specification shall apply with the following changes:

Replace the first sentence of first paragraph with the following text:

A RESTART message is sent by either side of PNNI in order to return virtual channels to the idle condition.

6.5.5.2 Receipt RESTART

See Section 2 §5.5.2/Q.2931 of [the UNI Signalling 4.1 UNI 4.0 signalling³](#) specification.

6.5.5.3 Restart collision

A restart collision occurs at PNNI when signalling entities on both sides of the interface simultaneously transmit a RESTART message. The call reference flag of the global call reference applies to restart procedures. In the case when both sides of the interface initiate simultaneous restart requests, they shall be handled independently. In the case when the same virtual channel(s) are specified, they shall not be considered free for reuse until all the relevant restart procedures are completed.

6.5.6 Handling of error conditions

Section 5.6 of the Recommendation Q.2931 shall apply with the following changes:

In the first paragraph, ‘Q.2931 user-network call control message’ is replaced by ‘PNNI signalling message’.
The references to sections ‘5.6.1’ and ‘5.6.8’, in the first and third paragraphs, are replaced by ‘6.5.6.1’ and ‘6.5.6.8’ respectively.

6.5.6.1 Protocol discrimination error

When a message is received with a protocol discriminator coded other than “PNNI signalling message”, that message shall be ignored. “Ignore” means to do nothing, as if the message had never been received.

6.5.6.2 Message too short

See Section 5.6.2 of the Recommendation Q.2931.

6.5.6.3 Call reference error

6.5.6.3.1 Invalid call reference format

See [Section 5.6.3.1](#) of the Recommendation Q.2931.

6.5.6.3.2 Call reference procedural errors

Section 5.6.3.2 of the Recommendation Q.2931 applies with the following change:

The references to sections ‘5.6.12’ and ‘5.6.11’ in list items ‘f’ and ‘g’ are replaced by ‘6.5.6.12’ and ‘6.5.6.11’ respectively.

6.5.6.4 Message type or message sequence errors

Section 5.6.4 of the Recommendation Q.2931 is replaced by the following:

The error procedures in this section apply only if the flag in the message compatibility instruction indicator is set to “message instruction field not significant”. If it is set to “follow explicit instructions”, the procedures in section 6.5.7 take precedence.

Whenever an unexpected message (including messages that are standardized by ITU-T but which are not included in this specification), except RELEASE, RELEASE COMPLETE, or an unrecognized message is received in any state other than Null state, a STATUS message shall be returned with one of the following causes:

#97 “*message type non-existent or not implemented*”; or,
#101 “*message not compatible with call state*”.

However, two exceptions to this procedure exist. The first exception is when the preceding or succeeding side of the PNNI receives an unexpected RELEASE message in response to a SETUP message. In this case no STATUS or STATUS ENQUIRY message is sent. Whenever the preceding or succeeding side receives an unexpected RELEASE message, the receiving entity shall: release the virtual channel and clear the connection; return a RELEASE COMPLETE message to the other side; release the call reference; stop all timers; enter the Null state and inform the PNNI Call Control entity.

The second exception is when the preceding or succeeding side receives an unexpected RELEASE COMPLETE message. In this case, the receiving entity shall: release the virtual channel, clear the connection; release the call reference; stop all timers; enter the Null state; and inform the PNNI call control entity.

6.5.6.5 Message length error

Section 5.6.5 of the Recommendation Q.2931 applies with the following change:

The reference to section '5.6.6' is replaced by '6.5.6.6'.

Add the following paragraph at the end of the section:

At the preceding side, if the length of a SETUP or ADD PARTY message to be forwarded exceeds the maximum message length supported by the SAAL, then the call or party, respectively, shall be rejected with cause # 111 "protocol error, unspecified", and the network management system should be notified.³

Note - When the Path trace feature [11] is supported, these error handling procedures shall be applied after the procedures of Section 4.3.7/[11].

6.5.6.6 General information element errors

6.5.6.6.1 Information element sequence

Section 5.6.6.1 of the Recommendation Q.2931 applies with the following change:

The references to section '4.5.1' are replaced by '6.4.5.1'.

6.5.6.6.2 Duplicated information elements

See Section 5.6.6.2 of the Recommendation Q.2931.

6.5.6.6.3 Coding standard error

Section 5.6.6.3 of the Recommendation Q.2931 applies with the following change:

The reference to section '5.6.7.2' is replaced by '6.5.6.7.2'.

The reference to section '5.6.8.2' is replaced by '6.5.6.8.2'.

6.5.6.7 Mandatory information element error

6.5.6.7.1 Mandatory information element missing

Section 5.6.7.1 of the Recommendation Q.2931 applies with the following change:

The reference to section '5.4' in the third paragraph is replaced by '6.5.3'.

6.5.6.7.2 Mandatory information element content error

Section 5.6.7.2 of the Recommendation Q.2931 applies with the following changes:

1. The reference to section '5.7' in the first paragraph is replaced by '6.5.7'.
2. The reference to section '5.4' in the fourth paragraph is replaced by '6.5.3'.
3. The note placed at the end of this section is not applicable.

6.5.6.8 Non-mandatory information element errors

The error procedures in this section apply only if the flag (bit 5) in the instruction field is set to "IE instruction field not significant". If it is set to "follow explicit instructions", the procedures in section 6.5.7 take precedence.

6.5.6.8.1 Unrecognized information element

Section 5.6.8.1 of the Recommendation Q.2931 shall apply with the following changes:

The first sentence of the third paragraph is replaced by the following:

If a clearing message contains one or more unrecognized information elements, the following procedures are used:

Add the following at the end of the section:

When a Broadband-locking shift information element occurs in a message, the Broadband-locking shift information element and all subsequent information elements may be treated as unrecognized information elements. However, when a Cause information element is generated to report errors of these shifted information elements the diagnostic field of the Cause information element (if present) should only include the information element identifier for the Broadband-locking shift information element and of any non-shifted information element in error.

When a Broadband-non-locking shift information element occurs in a message, the Broadband-non-locking shift information element and the subsequent information element may be treated as unrecognized information elements. However, when a Cause information element is generated to report errors of these shifted information elements the diagnostic field of the Cause information element (if present) should only include the information element identifier for the Broadband-non-locking shift information element and of any non-shifted information element in error.

6.5.6.8.2 Non-mandatory information element content error

Section 5.6.8.2 of the Recommendation Q.2931 applies with the following changes:

The reference to section '3' in the second paragraph is replaced by '6.3'.

6.5.6.8.3 Unexpected recognized information element

Section 5.6.8.3 of the Recommendation Q.2931 applies with the following change:

The reference to section '5.6.8.1' is replaced by '6.5.6.8.1'.

6.5.6.9 Signalling AAL reset

Section 5.6.9 of the Recommendation Q.2931 is replaced by the following text:

Whenever indication of a Signalling AAL reset is received from the SAAL layer by means of the AAL-ESTABLISH-INDICATION primitive, the following procedures apply:

- a) For calls in the clearing phase (states NN11 and NN12) no action shall be taken.
- b) Calls in the establishment phase (states NN1, NN3, NN6 and NN9) shall be maintained. Optionally, the status enquiry procedure may be invoked.
- c) Calls in the active state shall be maintained according to the procedures in other parts of section 6.5.

6.5.6.10 Signalling AAL failure

Section 5.6.10 of the Recommendation Q.2931 shall apply with the following changes:

1. The reference to section '5.6.11' in the second item of the second list is replaced by '6.5.6.11'.
2. The text of the fourth paragraph is replaced by the following text:

If timer T309 expires prior to Signalling AAL re-establishment, the affected entity shall: release the virtual channel; clear the connection; release the call reference; enter the Null state and inform the PNNI Call Control of the Signalling AAL re-establishment failure.
3. The last paragraph of the section is not applicable.

6.5.6.11 Status enquiry procedure

Section 5.6.11 of the Recommendation Q.2931 shall apply with the following changes:

1. The first paragraph is to be replaced by the following:

To check the correctness of a call state at the Preceding or Succeeding side of the PNNI, a STATUS ENQUIRY message may be sent requesting the call state. This may, in particular, apply to procedural error conditions described in 6.5.6.9 and 6.5.6.10.

2. The last paragraph of the section is replaced by the following:

If timer T322 expires, and no STATUS message was received, the STATUS ENQUIRY message may be retransmitted one or more times until a response is received. The number of times the STATUS ENQUIRY message is retransmitted is an implementation dependent value. If the number of retransmission of the STATUS ENQUIRY message exceed the limit, the call shall be cleared. The cause that should be used when clearing the call is cause #41 “temporary failure”. The ~~PNNI Call Control entity~~ network management system should³ ~~shall~~ be notified of the failure of the call.

6.5.6.12 Receiving a STATUS message

Section 5.6.12 of the Recommendation Q.2931 shall apply with the following changes:

The following text is added at the end of item ‘c)’ of the second list:

The PNNI Call Control entity shall be notified of the failure of the call.

6.5.7 Error procedures with explicit action indicator

6.5.7.1 Unexpected or unrecognized message type

6.5.7.1.1 Pass along procedures³

If the pass along request (bit 4) in the instruction field of a received message is set to “no pass along request”, the error handling procedures in Section 6.5.7.1.2 shall apply.

If the pass along request (bit 4) is set to “pass along request” in an unrecognized message, the following procedures shall apply :

1. If the next interface is a pass along capable interface (e.g. PNNI or AINI), the message shall be passed on without any change (except for mapping the call reference and if present endpoint reference values), and the other error handling procedures in Section 6.5.7.1.2 do not apply. Otherwise,
2. If the next interface is not a pass along capable interface, the error handling procedures in Section 6.5.7.1.2 shall apply.

An exception to the above occurs at an administrative boundary :

1. If the message is received from an interface that crosses an administrative domain boundary, the pass along request may or may not be granted, depending on network specific policy.⁽¹⁾
2. Similarly, if the next interface crosses an administrative domain boundary, the pass along request may or may not be granted, depending on network specific policy.⁽¹⁾
3. When a pass along request is denied, the error handling procedures in Section 6.5.7.1.2 shall apply.

¹ The decision to grant or deny a pass along request may be based on message type filtering. One possible mechanism is to use two lists configured at interfaces crossing an administrative boundary :

- "incoming pass along allowed" : this list contains the message type codepoints of the messages which are allowed to be passed along into the network from the administrative boundary at this interface.
- "outgoing pass along allowed" : this list contains the message type codepoints of the messages which are allowed to be passed along out of the network over the administrative boundary at this interface.

6.5.7.1.2 Message error procedures with explicit action indicator³

Section 5.7.1 of Recommendation Q.2931 shall apply with the following changes:

The reference to section '5.4.3 or 5.4.4' in the second paragraph of this section is replaced by '6.5.3'.

Add a new paragraph at the beginning of the section as follows:

~~The error procedures in this section apply to unrecognized messages only if the pass along request (bit 4) in the instruction field is set to "no pass along request". If it is set to "pass along request" in an unrecognized message, the message shall be passed on without, provided the next interface is a PNNI.~~

6.5.7.2 Information element error**6.5.7.2.1 Pass along procedures**³

If the pass along request (bit 4) in the instruction field of a received information element is set to "no pass along request", the error handling procedures in Section 6.5.7.2.2 shall apply.

If a mandatory information element with the pass along request flag is received, then the flag shall be ignored and the error handling procedures in Section 6.5.7.2.2 shall be followed.

If the pass along request (bit 4) is set to "pass along request" in an unexpected information element, an unrecognised information element, in a recognised non-mandatory information element with unrecognised contents or in a recognised non-mandatory information element with a length exceeding its maximum length, the following procedures shall apply:

1. If the next interface is a pass along capable interface (e.g. PNNI or AINI), the contents of the information element shall not be processed. The information element shall be included unaltered in the forwarded message and the other error handling procedures in Section 6.5.7.2.2 do not apply. Otherwise,
2. If the next interface is not a pass along capable interface, the error handling procedures in Section 6.5.7.2.2 shall apply.

An exception to the above occurs at an administrative boundary:

1. If the information element is received from an interface that crosses an administrative domain boundary, the pass along request may or may not be granted, depending on network specific policy.⁽¹⁾
2. Similarly, if the next interface crosses an administrative domain boundary, the pass along request may or may not be granted, depending on network specific policy.⁽¹⁾
3. When a pass along request is denied, the error handling procedures in Section 6.5.7.2.2 shall apply.

The pass along capability as defined above shall apply to information elements received in a message that is to be forwarded as another message by a node (e.g. ADD PARTY message to SETUP, or DROP PARTY to RELEASE, etc.).

¹ The decision to grant or deny a pass along request may be based on information element identifier filtering. One possible filtering mechanism is to use two lists configured at interfaces crossing an administrative boundary :

- "incoming pass along allowed" : this list contains the information element identifiers of the information elements which are allowed to be passed along into the network from the administrative boundary at this interface.
- "outgoing pass along allowed" : this list contains the information element identifiers of the information elements which are allowed to be passed along out of the network over the administrative boundary at this interface.

6.5.7.2.2 Information element error handling procedures with explicit action indicator³

See Section 5.7.2 of Recommendation Q.2931, ~~shall apply with the following changes:~~

~~Add a new paragraph at the beginning of the section as follows:~~

~~The error procedures in this section apply to unrecognized information elements only if the pass along request (bit 4) in the instruction field is set to "no pass along request". If it is set to "pass along request" in an unrecognized information element, the information element shall be passed on in the message without error checking, provided the next interface is a PNNI.~~

6.5.8 Handling of messages with insufficient information

Section 5.8 of Recommendation Q.2931 shall apply with the following changes:

The reference to sections '5.6.7.1' and '5.7.1' are replaced by '6.5.6.7.1' and '6.5.7' respectively.

6.5.9 Network node call control requirements

Any node that might take part in alternate routing must keep copies of the originally received SETUP message contents, including QoS and other parameters used to determine routing and call admission control, and also of any DTLs that it generated. Copies must also be kept of any blocked node or blocked link subfield contents received by the node during crankback procedures. The copies of the original SETUP message contents, additional DTLs, and possibly blocked transits should be kept until a CONNECT or ALERTING message is received from the following node, or until the call or party is cleared.

6.5.10 Notification procedures

See Section 5.9 of the Recommendation Q.2931.

6.5.11 Notification of interworking

If the Progress indicator information element is included in a call control message, the procedures of 6.5 apply. If the Progress indicator information element is included in the PROGRESS message, no state change will occur but any supervisory timers except T301 and T322 shall be stopped if the progress description is No.1, No. 2, or optionally No. 4.

6.5.12 List of Timers

The description of the timers for basic call will follow the timers defined in Table 7-1/Q.2931 of Recommendation Q.2931. The values in this table shall apply with the exception of the value of T310 which shall have the value of 30-120 seconds. The precise details are found in Section 6.5. Retransmission of SETUP messages is optional.

6.6 Call/connection Control Procedures for Point-to-Multipoint Calls

This section describes procedures for point-to-multipoint calls and uses ITU-T Recommendation Q.2971, as modified by ITU-T Recommendation Q.2971 Corrigendum 1, [43]³. It supports point-to-multipoint calls where user plane information is multicasted unidirectionally from one calling user to a set of called users. The network node will indicate the arrival of an add party request at the PNNI interface by transferring a SETUP (see Section 6.6.1) or ADD PARTY (see Section 6.6.2) message across the interface. The procedures for point-to-multipoint are based on ITU-T Q.2971 section 10.

6.6.1 Setup of the initial party

The procedures of ~~the~~ Section 10.2.1 of ITU-T Recommendation Q.2971 shall apply with the following changes:

1. Since the procedures apply between preceding and succeeding sides of the PNNI interface, replace the following items throughout the text:
 - “user-network interface” to “PNNI interface”.
 - “network” to “~~succeeding network node~~preceding side³”.
 - “user” to “~~preceding network nodes~~succeeding side³”.
2. Bullet two is not applicable. The bullet is shown below:

If a CALL PROCEEDING, ALERTING, or CONNECT messagethe procedures of subclause 9.2 (instead of the procedures of subclause 10.2.2).
3. Changes to section 9.2 of Q.2971
 - a) The first paragraph is to be replaced by the following:
The preceding and succeeding sides of the PNNI interface shall follow the procedures of section 6.5 with the following additions.
 - b) In the second paragraph delete sentence
The instruction indicator in the Endpoint reference information element shall be coded to “discard information element and proceed”.
 - c) Paragraph four is not applicable. The paragraph is shown below:
If a CALL PROCEEDING, ALERTING, or CONNECT message is the first message the procedures of subclause 9.2.1 shall be followed.
 - d) Last two paragraphs of section 9.2 are not applicable. The paragraphs are shown below:
At the terminating interface, the ADD PARTY, and DROP PARTY messages shall not be used.
At the terminating interface, the receipt of an ADD PARTY,message shall be treated as an unrecognized or unexpected message.
 - e) Section 9.2.1 is not applicable.

6.6.2 Adding a party

The procedures of ~~the~~ Section 10.2.2 of ITU-T Recommendation Q.2971 shall apply with the following changes:

1. Since the procedures apply between preceding and succeeding sides of the PNNI interface, replace the following items throughout the text:
 - “user-network interface” to “PNNI interface”.
 - “network” to “preceding side”.
 - “user” to “succeeding network node”.
2. For sections 10.2.2.1 through 10.2.2.5, when an ADD PARTY REJECT message is sent it shall include a Crankback information element with the crankback cause set to the same value as the specified cause value.
3. In Section 10.2.2.5, add the following paragraph:
If the received ADD PARTY REJECT message contains a Crankback information element, the procedures for crankback processing contained in Annex B apply.

Note that when an add party request is in the add party queue, it has no party state.

6.6.3 Party dropping

Apart from the exceptions identified in §10.3.2/Q.2971 (as modified below), the clearing procedures are symmetrical and may be initiated by either preceding or succeeding side of the PNNI. In the interest of clarity, the following procedures describe only the case where the preceding side initiates clearing.³

The procedures of ~~the~~ Section 10.3 of ITU-T Recommendation Q.2971 shall apply with the following changes:

1. Since the procedures apply between the preceding and succeeding sides of the PNNI interface, replace the following items throughout the text :
 - “user-network interface” to “PNNI interface”.
 - “user” to “preceding side”.
 - “network” to “succeeding side”.³
2. Section 10.3.2 list item a):
Change “the call clearing procedures of subclause 5.4.2/Q.2931 shall apply” to “the call clearing procedures of section 6.5.3.3 shall apply”.
3. Section 10.3.4 does not apply.³
4. Change “clearing procedures of subclause 5.4/Q.2931” to “clearing procedures of section 6.5.3” in sections 10.3.3, ~~10.3.4,~~³10.3.5 ~~and 10.3.6.~~
5. In Section 10.3.3, in the fourth bullet of the paragraph starting with "When the network receives a RELEASE message" replace "the procedures of section 10.2.1" by "the procedures of section 6.6.1".³
6. In Section 10.3.3, after the fourth bullet in the paragraph starting with “When the network receives a RELEASE message” add another bullet item:
 - If the received RELEASE message contains a Crankback information element, the procedures for crankback processing contained in Annex B apply.
7. Replace the text of section 10.3.6 by:
The preceding side can drop all parties of a call on the interface by sending a RELEASE message to the succeeding side. The succeeding side shall respond to the RELEASE message as specified in section 10.3.3/Q.2971 as modified above.

The succeeding side, while in the Active or Alerting Delivered link state may drop all parties on the interface by first sending an ADD PARTY REJECT message for each party in the Add Party Received party state and then sending a RELEASE message. The preceding side shall respond to the RELEASE message as specified in 10.3.3/Q.2971 (as modified above). In any other link state, the succeeding side shall use the call/connection clearing procedures of section 6.5.3 to clear the call and drop all parties.³

6.6.4 Restart procedures

The procedures of ~~the~~ Section 10.4 of ITU-T Recommendation Q.2971 shall apply.

6.6.5 Handling of error conditions

The procedures of ~~the~~ Section 10.5 of ITU-T Recommendation Q.2971 shall apply with the following changes:

Change “clearing procedures of subclause 5.4/Q.2931” to “clearing procedures of section 6.5.3” in section 9.5.7.2.

6.6.6 List of timers for point-to-multipoint

The list of timers specified in Section 13.2 of Q.2971 shall apply except for the default value of T399 which shall be in the range of 34-124 seconds.

7. Annex A: Designated Transit List

This Annex describes Designated transit lists. Designated Transit Lists (DTLs) indicate the transits (i.e., logical nodes and possibly logical links) that a connection is to traverse through a peer group at some level of hierarchy. The hierarchical nature of the representation of network topology leads to the representation of a hierarchically complete source route as a stack (last-in, first out list) of DTLs. The stack of DTLs is represented in the SETUP and ADD PARTY messages as a sequence of Designated transit list information elements.

Pseudocode for the procedures specified in this section are contained in Section 7.5. When there is an ambiguity in the narrative text, the pseudocode should be used to resolve the conflict. Where the text and the pseudocode are in disagreement, the text should be used as the prime source.

The DTL processing procedures carried out at each node along the path of a call are composed of two parts: First, the node determines whether any DTLs need to be added to the DTL stack and takes appropriate measures; second, the node determines whether any DTLs need to be removed from the stack and processes the remaining DTL stack to prepare it for transmission to the next node. Typically, a node either adds to the DTL stack or removes from the DTL stack. If a node both adds and removes DTLs from the stack, it must first remove the DTLs it added.

Each PNNI node along the path of a call can be categorized based on its role in DTL processing. The categories of a node in terms of generating DTLs are:

- a) DTL originator (see Section 7.2.1)
- b) Entry border node (see Section 7.2.2)
- c) Neither DTL originator nor entry border node (see Section 7.2.3)

The categories of a node in terms of removing DTLs are:

- d) DTL terminator (see Section 7.3)
- e) Exit border node (see Section 7.3)
- f) Neither DTL terminator nor exit border node (see Section 7.3)

Note that the DTL processing procedures for the latter three categories are described as one common set of procedures.

[Before executing the DTL procedures for the above categories, initialize the OneAncestorIsRestrictedTransit and LowestLeveExitBorderIsRestrictedTransit flags to FALSE.](#)³

7.1 Terminology

Call entering a peer group: A call is understood to be entering a peer group at a level of the hierarchy if it has been progressed to a border node to that peer group, across a logical link which is connected to another peer group.

Call exiting a peer group: A call is understood to be exiting a peer group at a level of the hierarchy if it is to be progressed by a border node to that peer group, across a logical link which is connected to another peer group.

7.2 Initial DTL processing

7.2.1 Procedures at the DTL originator

The DTL originator shall calculate a path across the routing domain towards the called party, as indicated in the SETUP or ADD PARTY message for the call/connection. If a Transit network selection information element is present, the transit network and optionally called party number shall be used to determine the path. The node at the end of the selected path must have connectivity to the called party number or transit network with advertised membership scope (see Section 5.8.1.3) at least as high as the path scope (defined as the highest level of PNNI hierarchy used by the path). In addition, if a Connection scope selection information element is present in the SETUP message, then the path scope must lie within the connection scope of the call (i.e., connection scope \leq level indicator of any node in the path \geq scope of advertisement of reachable address or transit network).

When the called party number is a group address (i.e., this call uses the ATM Anycast capability), the target of the path selection must be a member of the ATM group identified by the called party number. In this case, if no Connection scope selection information element is present in the SETUP message, a default connection scope of "localNetwork" shall be used for path selection purposes, (it is not included in the SETUP message).

The path is represented by a stack of DTLs. If no suitable path is found, the connection shall be cleared with the appropriate cause. If a Transit network selection information element is present, then cause #2 "no route to specified transit network" shall be used. Otherwise, cause #3 "no route to destination" shall be used.

The information about the path comprises all logical nodes (and optionally logical links) along the path which are known to the originating node, including:

1. the complete list of logical nodes (and optionally logical links) necessary to traverse the originating node's own peer group;
2. a list of logical nodes (and optionally logical links) which determines a path at higher levels of the hierarchy, ending with a logical node containing the DTL terminator.

The DTL originator shall append to the SETUP or ADD PARTY message a Broadband repeat indicator information element coded to indicate Last-in, First Out Stack, followed by one or more Designated transit list information elements. Designated transit list information elements shall be pushed onto the stack, thus, they appear in the reverse order in which they are to be traversed, i.e., the first Designated transit list information element to appear shall be that which includes the logical node that contains the DTL terminator, and the last Designated transit list information element to appear shall be that which contains the DTL originator.

Each Designated transit list information element shall contain, in the order which they are to be traversed, a list of transits at a single level of the hierarchy. This list shall start with the first logical node to be traversed at that level, and end at the last logical node or logical link to be traversed at that level. Whenever the path changes from one level of hierarchy to another, a Designated transit list information element shall be pushed onto the stack. The current transit pointer shall be set to 0, indicating the first logical node (and optionally logical link) in the designated transit list.

The top Designated transit list information element in the stack shall contain, in the order which they are to be traversed, a list of all of the logical nodes (and optionally logical links) within the DTL originator's own lowest level peer group, starting with the DTL originator, followed by the nearest neighbor logical node in the list and ending with either the DTL terminator (if in the DTL originator's own peer group) or the peer group exit border logical node (if the DTL terminator is not in the DTL originator's own peer group). The transit pointer shall be coded as 0, indicating the originating node.

If the sum of the lengths of the DTL information elements in the stack exceeds 1400 octets, the node should notify the network management system.³

Follow the procedures of Section 7.3.³

7.2.2 Procedures at an entry border node

When a call enters a peer group, the border node shall examine the top designated transit list information element in the SETUP or ADD PARTY message. If the logical node identifier indicated by the current transit pointer is not the same as the node ID of the border node's ancestor at the level of the common peer group for the receiving link, then the call shall be cleared with cause #41 "temporary failure" and optionally cranked back with either (i) a blocked transit type of "call or party has been blocked at the succeeding end of this interface"~~succeeding end blocked indicator~~¹ and crankback cause #128 "next node unreachable", or (ii) crankback cause #160 "DTL transit not my node ID" and the DTL transit listed as the blocked node. If the logical port identifier is not set to 0, it indicates the logical port to be used to progress the call when it exits the peer group.

The border node shall calculate a route across the peer group as follows:

a) It shall set the local OneAncestorIsRestrictedTransit flag as follows:

- If the logical node identifier indicated by the current transit pointer is a restricted transit node, then the OneAncestorIsRestrictedTransit flag shall be set to TRUE and the logical node identifier indicated by the current transit shall be saved.
- Otherwise the flag shall be set to FALSE.

Then, the border node shall examine the designated transit list at the top of the stack. If the current transit pointer indicates the end of the designated transit list, it shall perform the procedures of A.2.27.2.2 (b). Otherwise, ~~if the OneAncestorIsRestrictedTransit flag is set to TRUE, then the call shall be cleared with cause #2 "no route to specified transit network" or cause #3 "no route to destination" and cranked back with a blocked transit type of "blocked node" specifying the logical node identifier saved when the flag was set to TRUE as the blocked node, the blocked node's level as the crankback level subfield, and crankback cause #129 "node is a restricted transit node".~~ Otherwise, the border node³ shall proceed with A.2.27.2.2 (c), using, as the target of the path calculation, the transit immediately following the transit indicated by the current transit pointer.

b) Upon reaching the end of a designated transit list, it shall examine the next lower designated transit list on the stack, if there is one. If the logical node identifier indicated by the current transit pointer of the next designated transit list is not a node ID of one of the border node's ancestors, then the call shall be cleared with cause #41 "temporary failure" and optionally cranked back with crankback cause #160 "DTL transit not my node ID". If the current transit pointer does not indicate the first transit in the DTL, and the logical node identifier indicated by the current transit pointer is a restricted transit node, then the OneAncestorIsRestrictedTransit flag shall be set to TRUE and the logical node identifier indicated by the current transit shall be saved.³ If the logical port identifier is not set to 0 and no logical port has been specified yet, then the port identifier indicates the logical port to be used to progress the call when it exits the peer group. If the logical port identifier is not set to 0 and does not contain all logical ports found during previous recursions of these procedures (i.e., specified in DTLs at lower levels of the hierarchy), such that there is conflicting information as to which port to use to progress the call, then the call shall be cleared with cause #41 "temporary failure".

- If the current transit pointer indicates the end of that designated transit list, and there is a designated transit list lower on the stack, ~~the border node~~³ shall recursively repeat the procedures of A.2.27.2.2 (b).
- If the current transit pointer does not indicate the end of the designated transit list, the following actions shall be taken:
 - If the OneAncestorIsRestrictedTransit flag is set to TRUE, then the call shall be cleared with cause #2 "no route to specified transit network" or cause #3 "no route to destination" and cranked back with a blocked transit type of "blocked node" specifying the logical node identifier saved when the flag was set to TRUE as the blocked node, the blocked node's level as the crankback level subfield, and crankback cause #129 "node is a restricted transit node".
 - Otherwise, the border node~~it~~ shall proceed with A.2.27.2.2³ (c), using the transit immediately following the transit indicated by the current transit pointer as the target of the path calculation.

- If there is not a designated transit list lower on the stack, ~~it the border node~~ shall save the level of this DTL (at the bottom of the DTL stack) as the path scope before determining whether the node is the DTL terminator:
 - ~~In this case, it shall follow procedures as described in Section 7.3. Otherwise, it~~The border node shall then proceed with A.2.27.2.2³ (c), using as target of the path selection:
 - i) If a Transit Network Selection information element is present, the designated transit network and optionally the called party number.
 - ii) If no Transit Network Selection information element is present, the called party number.
 In this case, any port ID indicating a logical port to be used to progress the call shall be ignored.
- c) A path shall be calculated from the entry border node at the lowest level in which the entry border node appears towards the target as follows:

When the target is a node, if any of the border node's ancestors up to the level of the target is a restricted transit node, then the call shall be cleared with cause #2 "no route to specified transit network" or cause #3 "no route to destination" and cranked back with a blocked transit type of "call or party has been blocked at the succeeding end of this interface", with a crankback level subfield set as specified in Section 8.3.1.3, and crankback cause #129 "node is a restricted transit node".³

The node at the end of the selected path must have connectivity to the target with advertised membership scope (see Section 5.8.1.3) at least as high as the path scope (i.e., path scope \geq scope of advertisement of reachable address or transit network). When the target is a called party number that is a group address (for ATM anycast calls), the path must lead to a member of the ATM group with a sufficiently high membership scope.

When the target is not a node and any of the border node's ancestor is a restricted transit node, the selected path must lead to a node with connectivity to the target which is at a level that is lower than the lowest level restricted transit ancestor. If no such node with connectivity to the target can be found, yet removing this restriction would allow a node with connectivity to the target to be found, then the call shall be cleared with cause #2 "no route to specified transit network" or cause #3 "no route to destination" and cranked back with a blocked transit type of "call or party has been blocked at the succeeding end of this interface", with a crankback level subfield set as specified in Section 8.3.1.3, and crankback cause #129 "node is a restricted transit node".

When the target is not a node, the entry border node is a restricted transit node and it does not have connectivity to the target, then the call shall be cleared with cause #2 "no route to specified transit network" or cause #3 "no route to destination" and cranked back with a blocked transit type of "call or party has been blocked at the succeeding end of this interface". If removing the transit restriction would allow selection of a path to a node with connectivity to the target to be found, then the call shall be cleared with with a crankback level subfield set as specified in Section 8.3.1.3 and crankback cause #129 "node is a restricted transit node".

When the target is not a node, the entry border node is a restricted transit node and it has connectivity to the target, then this node shall be the DTL terminator.

If the selected path indicates that this node is the DTL terminator, then the entry border node shall set the LowestLevelExitBorderIsRestrictedTransit flag to FALSE and follow the procedures defined in section 7.3. ³

DTLs describing the selected path shall be pushed onto the DTL stack. These DTLs are pushed onto the stack in the reverse order in which they are to be traversed. Each DTL shall contain, in the order in which they are to be traversed, a list of transits at a single level of the hierarchy. The current transit pointers in these DTLs shall be set to 0, indicating the first transit. If no suitable path exists to the target of the path selection, then the call shall be cleared or cranked back with the appropriate cause, as determined according to the procedures of Section 8.2.4.³

Note: No current transit pointer shall be incremented, and no designated transit list shall be popped from the stack in the procedures of Section 7.2.2.

If the sum of the lengths of the DTL information elements in the stack exceeds 1400 octets, the node should notify the network management system. ³

Set the LowestLevelExitBorderIsRestrictedTransit flag to FALSE and ~~Follow~~ follow the procedures of Section 7.3, unless the call/connection has been cleared or cranked back.

7.2.3 Procedures at a node which is not the DTL originator or an entry border node

The top designated transit list information element in the SETUP or ADD PARTY message shall be examined. If the Node identifier indicated by the current transit pointer is not the same as that node's own node identifier, then the call shall be cleared with cause #41 "temporary failure" and optionally cranked back with either (i) a blocked transit type of "call or party has been blocked at the succeeding end of this interface"~~succeeding end blocked indicator~~¹ and crankback cause #128 "next node unreachable", or (ii) crankback cause #160 "DTL transit not my node ID" and the DTL transit listed as the blocked node.

If the node (at the lowest level) is a restricted transit node then:

- If the current transit pointer in the top designated transit list information element on the DTL stack does not point to the last transit in the DTL information element, then the call shall be cleared with cause #2 "no route to specified transit network" or cause #3 "no route to destination" and cranked back with a blocked transit type of "blocked node" specifying the current transit as the blocked node, and crankback cause #129 "node is a restricted transit node".
- If the current transit pointer indicates the end of the DTL, then the LowestLevelExitBorderIsRestrictedTransit flag shall be set to TRUE and the logical node identifier indicated by the current transit pointer shall be saved.

If this node (at the lowest level) is not a restricted transit node, then the local LowestLevelExitBorderIsRestrictedTransit flag for this call shall be set to FALSE.³

Follow the procedures of Section 7.3, unless the call/connection has been cleared or cranked back.

7.3 Next step in DTL processing

If the current transit pointer in the top designated transit list information element on the DTL stack (after the procedures of Section 7.2 have been completed) does not point to the last transit in the DTL information element and the LowestLevelExitBorderIsRestrictedTransit flag is set to TRUE (as specified in Section 7.2.3), then the call shall be cleared with cause #2 "no route to specified transit network" or cause #3 "no route to destination" and cranked back with a blocked transit type of "blocked node" specifying the logical node identifier saved when the flag was set to TRUE as the blocked node, the blocked node's level as the crankback level subfield, and crankback cause #129 "node is a restricted transit node".³

If the current transit pointer in the top designated transit list information element on the DTL stack (after the procedures of Section 7.2 have been completed) does not point to the last transit in the DTL information element, the current transit pointer shall be advanced. If the advanced transit pointer†:

- a) Indicates a transit which is a neighbor at the same level of hierarchy, the connection shall be progressed to that transit, using the specified logical port, if any. However, if the specified logical port does not correspond to a logical link to the next transit, then the call shall be cranked back with crankback cause #128 "next node unreachable" and cause #2 "no route to specified transit network" or cause #3 "no route to destination".
- b) Indicates a transit which is not a neighbor, the connection shall be cranked back with crankback cause #128 "next node unreachable" and cause #2 "no route to specified transit network" or cause #3 "no route to destination".

When the call is progressed, the SETUP or ADD PARTY message shall contain the stack of designated transit lists, as modified.

If the logical port identifier is not set to 0, it indicates a specific logical port to be used to progress the call.

If the current transit pointer indicates the end of the DTL, the DTL shall be popped from the stack, saving the level of the DTL as the path scope if this is the last DTL on the stack. If there are any DTLs remaining on the stack, the node shall examine the next designated transit list. If the logical node identifier indicated by the current transit pointer of the next designated transit list is not a node ID of one of the border node's ancestors, then the call shall be cleared with cause #41 "temporary failure" and optionally cranked back with crankback cause #160 "DTL transit not my node ID". If the logical port identifier is not set to 0 and does not contain all logical ports found during previous recursions of these procedures (i.e., specified in DTLs at lower levels of the hierarchy), such that there is conflicting information as to which port to use to progress the call, then the call shall be cleared with cause #41 "temporary failure". If the logical port identifier is not set to 0 and no logical port has been specified yet, then the port identifier indicates the logical port to be used to progress the call. The first specific logical port which is found during these procedures (i.e., the one at the lowest level of hierarchy of those specified) is to be used to progress the call.

The procedures of Section 7.3 shall then be recursively repeated.

If the DTL stack becomes empty, then this node is the DTL Terminator. With the exception of the port ID specified by the current transit pointer in the top DTL of the originally received DTL stack, any port ID indicating a logical port to be used to progress the call shall be ignored. If a Transit Network Selection information element is present and the indicated transit network is served by this node, then the node shall progress the call to the transit network using UNI procedures. If there is no Transit Network Selection information element and the called party is served by this node, then the node shall progress the call to the called party using UNI procedures. The connectivity from the DTL terminator to the transit network or called party number must have advertised membership scope higher than or equal to the path scope (i.e., scope of advertisement \leq path scope). When the called party number is a group address (i.e., this call uses the ATM anycast capability), the call may only be delivered to a member of the ATM group with a scope higher than or equal to the path scope.

If the DTL stack becomes empty but there is no connectivity with sufficient membership scope to the called party or transit network, then the call must be cleared or cranked back according to the procedures of Section 8.2.1.

7.4 Recommendations on Inclusion of Port IDs in DTLs

Specification of port IDs in DTLs is optional. In particular, port IDs may be set to zero to indicate that any port to the next node in the DTL stack can be used.

It is recommended, but not required, that port IDs be left unspecified whenever the next node in a DTL stack is represented in the topology database using the simple node representation or the default node representation. This allows for an entry border node in a logical group node to choose the exit border node leading outside of the logical group node, using knowledge of the topology of the child peer group represented by the logical group node. This will often result in better selection of the exit border node than can be achieved at the originating node, which has no knowledge of the internal topology of the child peer group. However, when other issues arise such as differentiation in policy between links to the next node, this recommendation need not be considered. When the next node in a DTL stack is represented using a complex node representation with one or more exceptions, it is recommended that the port ID be specified. In this case, the originating node takes advantage of its knowledge of the complex topology to cross the next node when computing a path. The originating node can choose links leading into ports that are appropriate for traversing the complex node. This is in contrast to the route computation carried out at entry border nodes, which normally do not consider the implications of routes that they select beyond the entry port into the target node.

7.5 Pseudocode of DTL procedures

The operations required to process the received stack of DTLs and to generate the new stack of DTLs are as follows:

- 1) receive a PNNI SETUP or ADD PARTY message.
- 2) extract a DTL stack from the SETUP or ADD PARTY message and initialize both OneAncestorIsRestrictedTransit and LowestLevelIsRestrictedTransit flags to FALSE.
- 3) does the current transit in the topmost DTL on the stack correspond to me at any level of the routing hierarchy?
 - a. yes: set the current node and current port (local variables) to the current transit in the topmost DTL on the stack.
 - b. no: abort, an error has occurred.
- 4) does the current node (from 3) correspond to me at the lowest possible level of the routing hierarchy?
 - a. yes: am I a restricted transit node (at the lowest level)?
 - a.1 yes: is the current transit pointer in the topmost DTL on the stack pointing to the last transit?
 - a.1.1 yes: set the LowestLevelExitBorderIsRestrictedTransit flag to TRUE and save my logical node identifier at the lowest level. goto 6
 - a.1.2 no: abort, an error has occurred
 - a.2 no: set the LowestLevelExitBorderIsRestrictedTransit flag to FALSE and goto 6.
 - b. no: am I at the corresponding hierarchy level a restricted transit node ?
 - b.1 yes: set the OneAncestorIsRestrictedTransit flag to TRUE and save my logical node identifier at the corresponding hierarchy level, and goto b.3.
 - b.2 no: set the OneAncestorIsRestrictedTransit flag to FALSE, and goto b.3.
 - b.3 is the current transit pointer referencing the last element in the DTL?
 - b.3.1 yes: are there any other DTLs lower down on the stack?
 - b.3.1.1 yes: check the next DTL down on the stack.
(Note: do *not* pop any DTLs off the stack at this stage.)
Does the current transit in the DTL correspond to me at any level of the routing hierarchy?
 - b.3.1.1.1 yes: if the current transit pointer does not indicate the first transit in the DTL, and I am a restricted transit node at the corresponding hierarchy level, then set the OneAncestorIsRestrictedTransit flag to TRUE, and save my logical node identifier at the corresponding hierarchy level.-is
Is the current port set to zero (unspecified)?
 - b.3.1.1.1.1 yes: reset the current port to that of the current transit in this DTL. goto b.3.
 - b.3.1.1.1.2 no: is the current port included within the current transit's port in this DTL?
 - b.3.1.1.1.2.1 yes: goto b.3.
 - b.3.1.1.1.2.2 no: abort, an error has occurred.
 - b.3.1.1.2 no: abort, an error has occurred.
 - b.3.1.2 no: you have arrived at a logical group node that has reachability to the called party number or specified transit network. Set the path scope (a local variable) to the level of this DTL (at the bottom of the DTL stack), and set the target (a local variable) to the called party number and/or specified transit network in the SETUP or ADD PARTY message.
 - b.3.2 no: is the OneAncestorIsRestrictedTransit flag set to TRUE ?
 - b.3.2.1 yes: abort, an error has occurred.
 - b.3.2.2 no: set the target (a local variable) to the next entry in the DTL.
(note: do *not* advance the current transit pointer at this stage.)

- 5) determine a route across the current node (from 3) and through the current port (from 3 or 4) to the target (from 4). ~~When the target is the called party number and/or specified transit network, the path must lead to a node with connectivity to the target of scope higher than or equal to the path scope.~~
is the target a node?
 a. yes: is any of the border node's ancestors up to the level of the target a restricted transit node ?
 a.1: yes: abort, an error has occurred.
 a.2: no: goto c.
 b. no: the path must lead to a node with connectivity to the target of scope higher than or equal to the path scope.
is the entry border node (at the lowest level) a restricted transit node?
 b.1 yes: does the entry border node have connectivity to the target?
 b.1.1 yes: this node shall be the DTL terminator. goto c.1.
 b.1.2 no: abort, an error has occurred.
 b.2 no: is any of the border's node ancestors a restricted transit node?
 b.2.1 yes: the selected path must lead to a node with connectivity to the target which is at a level that is lower than the lowest level restricted transit ancestor. If no such node with connectivity to the target can be found, then abort, an error has occurred. Otherwise, goto c.
 b.2.2 no: goto c.
 c. does the selected path indicate that this node is the DTL terminator?
 c.1 yes: the entry border node shall set the LowestLevelExitBorderIsRestrictedTransit flag to FALSE and goto 6.
 c.2 no: ~~Convert~~ convert the resulting path into a set of DTL information elements and push the resulting DTL information elements onto the current DTL stack. ** Set the LowestLevelExitBorderIsRestrictedTransit flag to FALSE
- 6) set the output port (a local variable) to that of the current transit in the topmost DTL on the stack. Begin step 7 using the topmost DTL on the stack.
- 7) is the current transit pointer in the topmost DTL on the stack not pointing to the last transit and is the LowestLevelExitBorderIsRestrictedTransit flag set to TRUE ?
 a. yes: abort, an error has occurred.
 b. no: is the current transit pointer referencing the last element in the DTL?
 b.1a. yes: is this the last DTL on the stack?
 ab.1.1 yes: you have arrived at a node that has direct reachability to the called party number or specified transit network. Set the path scope (a local variable) to the level of this DTL, then pop the DTL off the stack. The connectivity to the called party number or specified transit network must have scope higher than or equal to the path scope. Send a UNI SETUP message directly to the called party or specified transit network.
 ab.1.2 no: pop the DTL off the stack. Does the current transit in the next DTL on the stack correspond to me at any level of the routing hierarchy?
 ab.1.2.1 yes: is the output port set to zero (unspecified)?
 ab.1.2.1.1 yes: reset the output port to that of the current transit in this DTL. goto 7.
 ab.1.2.1.2 no: is the output port included within the current transit's port in this DTL?
 ab.1.2.1.2.1 yes: goto 7.
 ab.1.2.1.2.2 No: abort, an error has occurred.
 ab.1.2.2 no: abort, an error has occurred.
 b.2 no: continue.
- 8) advance the current transit pointer in the topmost DTL on the stack.
- 9) put the resulting DTL stack back into the SETUP or ADD PARTY message.
- 10) send the PNNI SETUP or ADD PARTY message directly to the current transit listed in the topmost DTL on the stack, through the output port.

** The way to specify a path and convert the resulting path to a DTL stack can be described in many ways. These possible descriptions vary depending on where to draw the line between the routing algorithm and the specification of DTLs.

To summarize the algorithm, the main steps are as follows:

- determine current node (including current level of hierarchy) (step 3)
- determine target of path selection (step 4)
- determine route and push path onto stack of DTLs (step 5)
- determine output port (step 6)
- pop completed DTLs from stack (step 7)
- advance current transit pointer (step 8)

7.6 Exterior Routes and DTLs

Exterior routes are by definition routes which leave the PNNI routing domain. In many or most cases the organizations which are managing the exterior networks will not want to expose any internal topology within their network. Thus even if a DTL were used, it would provide little details of the exterior route.

There is no guarantee that all PNNI routing domains worldwide will use a consistent definition of levels. Thus, if a DTL were used for an exterior route, it might not be possible for the DTL to make use of consistent level indicators (the first octet of each node ID) along the path.

Therefore, where a path makes use of an exterior route, the DTL will terminate at the node (or node and specified port) which is advertising the exterior route into the PNNI Routing Domain.

8. Annex B: Crankback Procedures

This annex describes the additional clearing procedures and behavior of PNNI nodes during crankback. Crankback is indicated by including a Crankback information element in the first call clearing message (RELEASE, RELEASE COMPLETE, or ADD PARTY REJECT). These procedures are additional procedures to the clearing procedures described in Section 6.5.3.

8.1 Scope of Crankback Procedures

A call that cannot be progressed within a PNNI domain may be subject to crankback. This specification indicates those cases where crankback within a PNNI domain is required. Whenever the specification indicates call clearing with specific cause codes, crankback shall not be performed unless stated explicitly.

Any call that progresses all the way to the called user and gets rejected by the called user will not be cranked back. This includes rejections by the called user that happen when a problem is discovered at the called user's end of the UNI, as well as rejections from within the endpoint or user system. In such cases a RELEASE or RELEASE COMPLETE message with a Cause information element will be returned. This will result in the call being cleared all the way back to the calling user. These are not crankback situations, and no alternate routing is to be attempted in these cases.

Calls that get rejected when the DTL Terminator determines that the UNI to the called user cannot carry the call may be cranked back, similarly to cases where call rejection occurs at PNNI interfaces, but in these cases crankback is not required.

The cases where crankback is used in PNNI fall into three categories:

- Reachability errors
- Resource errors
- DTL processing errors

The DTL processing errors can be considered as a subset of reachability errors, as they are usually the result of changes in connectivity.

In addition to these categories, it is possible for a call to be cranked back because the path selection at some node determines that there are no paths that meet the policy constraints. Specification of policy constraints in general has been deferred to later releases of PNNI, so definition of policy violations and crankback cause codes are not included in this specification.

8.2 Crankback Cause

In case of call clearing, a Cause information element is mandatory in the first call clearing message. In case of crankback, a Crankback information element must be included as well as the Cause information element. The Crankback information element must include a crankback cause code, which is used instead of the Cause information element within the PNNI domain.

Note that the cause code and diagnostics in the Crankback information element may be updated whenever the identity of the blocked node or link is changed. Specifically, this is done whenever cranking back beyond an entry border node that had originally specified a DTL including a blocked node or link.

8.2.1 Reachability Errors

Generally, reachability errors indicate that a path to a destination could not be found. This applies to both intermediate destinations in the DTL(s) in the SETUP/ADD PARTY message, and to the final destination (transit network or called party). This type of failure indicates that no path within the scope of the received DTL stack exists to the destination. It is different from finding a path that exists but does not satisfy the requested QoS; such failures are discussed in Section 8.2.2 as Resource Errors.

Whenever crankback occurs due to reachability errors, the blocked transit specified in the Crankback information element must be a blocked link. If the next node, transit network, or called party address cannot be reached from this node through any logical link, then the Blocked link's port ID shall be set to zero. If the next node, transit network, or called party address cannot be reached through a port specified in the DTL stack, then the Blocked link's port ID shall be set to that port ID. For unreachable transit networks and called party addresses, the Blocked link's succeeding node ID shall be set to all zeros.

8.2.1.1 Destination unreachable and transit network unreachable

These cause codes are returned when a node receives a SETUP/ADD PARTY message with a DTL stack indicating that it is the last node in the path, but from which there is no connectivity of scope at least as high as the path scope to the called party or transit network. In the case where no reachability information whatsoever exists in the node's link state database for the called party or transit network, the call shall be cleared with cause #2 "no route to specified transit network" or cause #3 "no route to destination". Similarly, if the only best match address prefixes are summary addresses advertised by this node or one of its ancestors, the call shall be cleared with ~~cause #2 "no route to specified transit network" or~~ cause #3 "no route to destination".

If the node's link state database includes reachability information for the called party or transit network, but only at one or more different nodes (that are not ancestors of this node), the call shall be cranked back with cause and crankback cause #2 "no route to specified transit network" or cause and crankback cause #3 "destination unreachable". This case may occur when a call enters a certain partition of a peer group that has become partitioned. This crankback cause code indicates that the node doing the crankback believes that although the destination is not within its partition of the peer group, the destination is possibly still reachable via some other partition.

In the case of partitioned peer groups it is possible that more than one logical node will be advertising reachability to a given destination. The advertisement in question may be a summary which is being advertised by two logical nodes. Any one specific destination within the summary will only be reachable via one of the partitions, otherwise the partition would not exist. When crankback cause #3 "destination unreachable" is specified, the node that generated the DTL which resulted in the SETUP or ADD PARTY message being sent to the wrong partition shall either a) also be able to see the other partition(s) or b) not be able to see the other partition(s). If a), then alternate routing can be attempted for the call; If b) the call can be cranked back further or cleared.

A node only attempts alternate routing within the scope of the DTL it receives. If all possible alternate paths or partitions have been tried, the call must be cleared or cranked back further, as determined by applying these procedures iteratively.

8.2.1.2 Next node unreachable

This cause code is returned when the next transit in the DTL stack is not directly reachable from this node. Whenever this case occurs, the call shall be cranked back with crankback cause #128 "next node unreachable". The cause code used in the Cause information element shall be set to cause #2 "no route to specified transit network", if a Transit network selection information element is present, or cause #3 "no route to destination", otherwise.

8.2.2 Resource Errors

8.2.2.1 Resource Errors Due To Service Category

Crankback can occur due to unsupported service category or bearer class. See Sections 6.5.2.3.1 and 6.5.2.7 for further details.

8.2.2.2 Resource Errors Due to Traffic and QoS Parameters

The resources needed to support a call are calculated from the traffic parameters and/or QoS parameters included in the SETUP or ADD PARTY message. Resource Errors are used to signal that a path could not be found for the call to satisfy the requested traffic and QoS parameters.

Inability to satisfy the requested traffic and QoS parameters can either be detected during GCAC/path selection (see Section 5.13), or during actual CAC (see Section 6.5.2.3). Calls that are rejected in PNNI domains due to insufficient resources are always cranked back.

If the requested user cell rate(s) from the ATM traffic descriptor information element cannot be satisfied, the call will be cranked back with crankback cause #37, "user cell rate not available". Updated value(s) of the relevant generic CAC parameters of the blocked node/link may also be included (see Section 8.4).

If no path can be found to satisfy the requested maximum CTD, peak-to-peak CDV, and/or CLR (in one and/or the other direction for a call), the call will be cranked back with cause and crankback cause #49, "QoS unavailable". The specific QoS parameter(s) that caused the call rejection are indicated in the diagnostics by setting the appropriate bits to "CTD unavailable", "CDV unavailable", and/or "CLR unavailable", respectively.

When blocking due to insufficient resources occurs, it must be determined whether blocking was due to insufficient resources at the succeeding end of the previous link (calls requesting similar resource requirements on other ports might be accepted), insufficient resources at the preceding end of the following link (calls requesting similar resource requirements on other ports might be accepted), or insufficient resources within the node itself (all calls requesting similar resource requirement from this node are likely to be blocked). Depending on the answer, the procedures in Section 8.3.1.3, 8.3.1.2, or 8.3.1.1, respectively, shall apply.

8.2.2.3 Resource Errors Due to VPCI/VCI Allocation

When the preceding side is unable to allocate a VPCI (for SVPCs) or a VPCI/VCI pair (for SVCs), the procedures of Section 8.3.1.2 shall be followed. If no alternate routing is attempted or if alternate routing fails, crankback cause #45 "No VPCI/VCI available" shall be used.

Resource errors due to VPCI/VCI allocation at the succeeding side result in crankback with cause #35 "Requested VPCI/VCI not available" or cause #45 "No VPCI/VCI available", as discussed in Sections 6.5.2.2.1 and 6.5.2.2.2. Whenever VPCI/VCI resource errors occur at the succeeding side of a PNNI interface, the blocked transit type in the Crankback information element must be set to "call or party has been blocked at the succeeding end of this interface".

8.2.3 DTL Processing Errors

When a node receives a Designated transit list information element in which the logical node identifier indicated by the current transit pointer does not identify the node or one of its ancestor nodes, crankback may occur. These types of DTL processing errors may occur temporarily due to changes in connectivity, in particular when a change in peer group leader occurs and a new parent logical group node is created. The Crankback information element generated in this case will include either (i) a [blocked transit type of "call or party has been blocked at the succeeding end of this interface" succeeding end blocked indicator¹](#) and crankback cause #128 "next node unreachable", or (ii) crankback cause #160 "DTL transit not my node ID" and the DTL transit listed as the blocked node, as discussed in Annex A.

When a node receives a Designated transit list information element and the node cannot progress the call due to restricted transit constraints, crankback will occur. These types of DTL processing errors may occur:

1. When a particular entry border node or one of its ancestor nodes is configured as a restricted transit node, and a call is received over an outside link of the entry border node, where the outside link's common peer group is at a higher level of hierarchy than the particular entry border node or its ancestor (i.e. path selection from the originating node could not avoid such lower level restricted transit nodes because the originating node cannot see them). It is generally recommended that restricted transit nodes not be border nodes since a disproportionate number of calls may need to be cranked back in order to be successfully established.
2. When restricted transit topology information has not been completely flooded to all nodes yet and path selection for those nodes that do not have the updated information select paths that contain restricted transit nodes in them (this is a transient state).
3. When not all nodes in a network generate paths that avoid restricted transit nodes.

The Crankback information element generated in this case will include either (i) a blocked transit type of "call or party has been blocked at the succeeding end of the this interface" and crankback cause #129 "node is a restricted transit node", or (ii) a blocked transit type of "blocked node" and crankback cause #129 "node is a restricted transit node", as discussed in Annex A.³

8.3 Procedures for Crankback Level and Blocked Transit

This section describes the procedures used for generating, interpreting, and modifying the crankback level, the blocked transit type, and the blocked transit identifier. These procedures provide the mechanisms required to manage crankback from the point of blocking, through intermediate nodes, to one or more nodes that are allowed to choose alternate routes for the call.

The crankback level and blocked transit type are used during crankback to determine which nodes are allowed to choose alternate routes or alternate links, respectively. In order to indicate the node(s) or link(s) at which problems occurred, the Crankback information element includes a blocked transit identifier subfield in addition to the blocked transit type. The blocked node or link must be avoided in all alternate routes attempted for this call.

Pseudocode for the procedures specified in this section is contained in Section 8.3.3. When there is an ambiguity in the narrative text, the pseudocode should be used to resolve the conflict. Where the text and the pseudocode are in disagreement, the text should be used as the prime source.

8.3.1 Procedures at the Point of Blocking

The procedures carried out at the point of blocking vary depending on whether crankback occurs due to problems at the input port, at the output port, or within the node itself. These procedures are discussed in Sections 8.3.1.3, 8.3.1.2, and 8.3.1.1, respectively.

8.3.1.1 Blocking at a node

Upon blocking at a node, crankback procedures are initiated by sending an appropriate call/connection clearing message (RELEASE, RELEASE COMPLETE, or ADD PARTY REJECT) including a Crankback information element. The Crankback information element must include a crankback level subfield whose value is set to the level of the first node ID indicated in the top DTL of the stack. The blocked transit type must be set to "blocked node" and the blocked transit identifier must indicate the node's own node ID at the corresponding level of hierarchy, as indicated by the current transit pointer in the top DTL on the stack in the received SETUP or ADD PARTY message. The Crankback information element also contains the crankback cause subfield.

8.3.1.2 Blocking at the preceding end of a link

Link blocking can be determined at the preceding end of a link when connection admission control (CAC) within the node at the preceding end of the link determines that insufficient resources are available. If the node at the preceding end of the link is an entry border node or the DTL originator! for the call, then the procedures of Section 8.3.2.2 shall apply. Otherwise, if other links exist that still satisfy the DTLs in the SETUP or ADD PARTY message received by this node, then alternate routing may be attempted.

If no alternate routing is attempted or if alternate routing fails, then the node at the preceding end of the link must crankback the call or party by sending an appropriate clearing message (RELEASE, RELEASE COMPLETE, or ADD PARTY REJECT) including a Crankback information element. The Crankback information element must include a crankback level subfield whose value is set to the level of the first node ID indicated in the top DTL of the stack. The blocked transit type subfield must be set to “blocked link”, and the blocked transit identifier must indicate the identity of the blocked link. The Blocked link’s preceding node identifier and port identifier are set to the node and port IDs indicated by the current transit pointer in the top DTL on the stack in the received SETUP or ADD PARTY message. The Blocked link’s succeeding node ID is set to the next node ID in the top DTL on the stack, if the current transit is not the last node in the DTL, or to the node ID of the next node determined from the received DTL stack (see Section 7.3), if this node is an exit border node for the call. However, if this node is the DTL Terminator, then the blocked link’s succeeding node ID is set to all zeros.

8.3.1.3 Blocking at the succeeding end of a link

Link blocking can be determined at the succeeding end of a link when CAC within the node at the succeeding end of the link determines that insufficient resources are available. In this case, the node must crankback the call or party by sending an appropriate clearing message (RELEASE, RELEASE COMPLETE, or ADD PARTY REJECT) including a Crankback information element. The Crankback information element must include a crankback level subfield whose value is set to the level of the first node ID indicated in the top DTL of the stack. The blocked transit type must be set to “call or party has been blocked at the succeeding end of this interface”. The Crankback information element also contains the crankback cause subfield.

8.3.2 Receiving a clearing message with a Crankback information element

Upon receiving a clearing message (RELEASE, RELEASE COMPLETE, or ADD PARTY REJECT) including a Crankback information element, a node first checks whether the blocked transit type indicates that the “call or party has been blocked at the succeeding end of this interface”. In this case, the procedures of Section 8.3.2.1 must be followed. Otherwise, if the node generated any DTLs for this call of equal or higher level than the crankback level, then the procedures of Section 8.3.2.2 must be followed. Otherwise, the node must crankback the call or party by sending an appropriate clearing message (RELEASE or ADD PARTY REJECT) including an unchanged Crankback information element over its previous interface (towards the calling party).

8.3.2.1 Receiving a clearing message indicating blocking at this interface

When a clearing message (RELEASE, RELEASE COMPLETE, or ADD PARTY REJECT) is received which includes a Crankback information element with blocked transit type indicating “call or party has been blocked at the succeeding end of this interface”, the following procedures are carried out. If the node at the preceding end of the link is an entry border node for the call, the procedures of Section 8.3.2.2 shall apply. Otherwise, if other links exist that still satisfy the DTLs in the SETUP or ADD PARTY message received by this node, then alternate routing may be attempted. In addition, a SETUP message may only be resent on the blocked link with a different VPCI (for SVPCs) or VPCI/VCI pair (for SVCCs) if crankback cause #35 “Requested VPCI/VCI not available” is present.

If no alternate routing is attempted or if alternate routing fails, then the node must continue to crankback the call or party. The blocked transit type subfield must be changed to indicate “blocked link”, and a blocked transit identifier must be inserted into the Crankback information element. The Blocked link’s preceding node identifier and port identifier are set to the node and port IDs indicated by the current transit pointer in the top DTL on the stack in the received SETUP or ADD PARTY message. The Blocked link’s succeeding node ID is set to the next node ID in the top DTL on the stack, if the current transit is not the last node in the DTL, or to the node ID of the next node determined from the received DTL stack (see Section 7.3), if this node is an exit border node for the call. However, if this node is the DTL Terminator, then the blocked link’s succeeding node ID is set to all zeros. The Crankback information element must include a crankback level subfield whose value is set to the level of the first node ID indicated in the top DTL of the stack. After the above changes to Crankback information element have been made, the node shall send an appropriate clearing message (RELEASE or ADD PARTY REJECT) over its previous interface (towards the calling party).

8.3.2.2 Receiving a clearing message at the entry border node at the crankback level

The node that generated the DTL at the crankback level has been reached. This node must determine whether to try alternate routing or to continue cranking back the call or party. If crankback continues, then the call shall be progressed according to the procedures of Section 8.3.2.2.2. If alternate routing is attempted, then the call shall be progressed according to the procedures of Section 8.3.2.2.1.

8.3.2.2.1 Alternate routing

If alternate routing is attempted, the routing computation must produce a path consistent with the DTLs in the originally received SETUP or ADD PARTY message, that does not contain any blocked nodes and/or links received in the Crankback information element of any clearing messages (RELEASE, or ADD PARTY REJECT). Except as a result of those procedures normally undertaken by entry border nodes, the SETUP or ADD PARTY message progressed should be similar to the originally received SETUP or ADD PARTY message.

8.3.2.2.2 Crankback to next higher level

If alternate routing is not attempted or if alternate routing fails to find a suitable path across the peer group, then crankback must proceed to the entry border node of the next higher-level peer group. The crankback level must be set to the level of the first node in the top DTL on the stack in the received SETUP or ADD PARTY message. The identity of the blocked node or link in the crankback information element must be changed, to reflect a node or link known to the parent peer group as opposed to a node or link known to the child peer group.

If only nodes and/or links internal to the peer group were returned as blocked nodes or links in the Crankback information element of RELEASE, or ADD PARTY REJECT messages, then the logical node corresponding to the peer group should be listed as blocked. In this case, the blocked node ID should match the node ID indicated by the current transit pointer in the top DTL on the stack in the received SETUP or ADD PARTY message.

If at least one of the routing attempts was blocked at a link exiting the peer group, then the logical link exiting the logical group node representing the peer group should be listed as blocked. Specifically, the blocked link’s preceding node ID and port ID should be set to the values indicated by the current transit pointer in the top DTL on the stack in the received SETUP or ADD PARTY message, and the blocked link’s succeeding node ID should be set to the node ID of the target of the path calculation, as determined from the received DTL stack in the procedures of Section 7.2.2. However, if the target of the path calculation is not a node, then the blocked link’s succeeding node ID is set to all zeros.

8.3.2.3 Additional procedures for point-to-multipoint calls/connections

The procedures for processing clearing messages with crankback for point-to-multipoint calls/connections are the same as those for point-to-point calls/connections, except when a RELEASE or RELEASE COMPLETE message is received and there are queued ~~add party~~ADD PARTY requests on the ~~add party~~ADD PARTY queue ~~for this call/connection~~¹.

~~The first step in the additional procedures is to determine which add party requests are affected. If the network node does not attempt alternate routing for the party for which~~ the RELEASE or RELEASE COMPLETE message was received, and the blocked transit in the crankback information element is the succeeding end of this interface, then ~~all queued add party requests are affected~~~~the network node shall send an ADD PARTY REJECT message for each queued ADD PARTY request towards the preceding network node, with the crankback indication according to the previous sub-sections.~~¹

~~If the network node does not attempt alternate routing for the party for which~~ the RELEASE or RELEASE COMPLETE message was received, and the blocked transit in the crankback information element is not the succeeding end of this interface, then the network node ~~shall crank back the party for which the RELEASE or RELEASE COMPLETE message was received, and may~~¹ either:

1. ~~Consider none of the queued add party requests affected~~~~Progress one of the ADD PARTY requests on the ADD PARTY queue by sending a SETUP message, leaving the remaining ADD PARTY requests pending~~¹, or
2. ~~consider only those queued add party requests whose DTLs contain the blocked transit to be affected~~~~Crank back all ADD PARTY requests on the ADD PARTY queue whose DTLs contain the blocked transit, and progress one of the ADD PARTY requests remaining on the ADD PARTY queue (if any) by sending a SETUP message, leaving the remaining ADD PARTY requests pending.~~¹

~~Note that paths of pending add party requests (e.g. unaffected add party requests) must be considered as part of the connection tree when choosing alternate routes for affected add party requests, and for the initial party whose route was rejected when the RELEASE or RELEASE COMPLETE message was received (see Section 5.13).~~¹

~~If there are any unaffected add party requests remaining on the queue, the network node shall progress one of the unaffected add party requests remaining on the add party queue by sending a SETUP message, leaving the remaining unaffected add party requests pending.~~¹

~~Affected queued add party requests must either be rejected or rerouted so as to avoid the blocked node or link (subject to the normal rules for DTL processing). For each affected queued add party request~~~~If alternate routing is attempted for the party for which the RELEASE or RELEASE COMPLETE message was received, the node shall determine if and how the queued ADD PARTY requests can be satisfied. If the request can be satisfied by adding it to a branch which is in the Active state, then it shall send an ADD PARTY message to the corresponding succeeding node. If a new branch is required and the branch is in the Null state, it shall send a SETUP message to the corresponding succeeding node. If a new branch is required, and the branch is in the Call Initiated, Outgoing Call Proceeding, or Call Delivered state, then it shall queue the party. More than one branch may be needed to satisfy all the queued add party~~ADD PARTY requests. If an ~~affected add party~~ADD PARTY request cannot be satisfied, then the network node shall send an ADD PARTY REJECT message for that ~~add party~~ADD PARTY request toward the preceding network node, with the crankback indication according to the previous sub-sections. The manner in which the node determines whether an ~~affected add party~~ADD PARTY¹ request can be satisfied, and how it will do so, is implementation specific.

8.3.3 Pseudocode of Crankback Procedures

The operations required when blocking is detected at a node:

- 1) Blocking was due to insufficient resources at the:
 - a. whole node:
 - call or party clearing message is returned including:
 - crankback level = level of node ID in top DTL on stack
 - blocked transit type = blocked node
 - blocked node ID = node ID of current transit in top DTL on stack.
 - b. preceding end of the following link:
 - this node added any DTLs? (was an entry border node for this call?)
 - b.1 yes: goto 2.b.1+1.
 - b.2 no: does this node support alternate routing using alternate link and¹ are other links satisfying received DTLs available?
 - b.2.1 yes: try alternate links.
 - b.2.2 no: call or party clearing message is returned including:
 - crankback level = level of node ID in top DTL on stack
 - blocked transit type = blocked link
 - blocked link's preceding node ID = node ID of current transit in top DTL on stack
 - blocked link's port ID = port ID of current transit in top DTL on stack
 - blocked links succeeding node ID =
 - (if not an exit border node or DTL Terminator)
 - next node ID (after current transit) in top DTL on stack
 - (if exit border node)
 - next node determined from received DTL stack (in steps 7 and 8 of DTL processing pseudocode).
 - (if DTL Terminator)
 - all zeros.
 - c. succeeding end of the previous link:
 - call or party clearing message is returned including:
 - crankback level = level of node ID in top DTL on stack
 - blocked transit type = call or party blocked at succeeding end of interface.

The operations required when receiving a clearing message with a Crankback information element:

- 2) does blocked transit type = call or party blocked at succeeding end of interface?
 - a. yes: is crankback cause “requested VPCI/VCI not available”?
 - a.1 yes: retry SETUP on same link using different VPCI/VCI values
 - a.2 no: this node added any DTLs? (was an entry border node for this call?)
 - a.2.1 yes goto 2.b.1
 - a.2.2 no does this node support alternate routing using alternate link and! are other links satisfying received DTLs available?
 - a.2.2.1 yes: try alternate links.
 - a.2.2.2 no:
 - call or party clearing message is returned including:
 - crankback level = level of node ID in top DTL on stack
 - blocked transit type = blocked link
 - blocked link’s preceding node ID = node ID of current transit in top DTL on stack
 - blocked link’s port ID = port ID of current transit in top DTL on stack
 - blocked links succeeding node ID =
 - (if not an exit border node or DTL Terminator)
 - next node ID (after current transit) in top DTL on stack
 - (if exit border node)
 - next node determined from received DTL stack (in steps 7 and 8 of DTL processing pseudocode).
 - (if DTL Terminator)
 - all zeros.
 - b. no: no—This node generated any DTLs of equal or higher level than the crankback level?
 - b.1 Yes: yes—The node that generated the DTL at the crankback level has been reached (the node is an entry border node, or the DTL originator)
 - Try alternate routing?
 - b.1.1 Yes: (copy of SETUP or ADD PARTY was saved)
 - is there an alternate path that does not violate received DTLs and does not include any blocked transits received in RELEASE messages?
 - b.1.1.1 Yes: send SETUP or ADD PARTY on new path
 - (new path necessarily results in new DTLs at least up to the one being cranked back)
 - b.1.1.2 No:
 - crankback to next higher level in DTL stack **
 - crankback level = level of node ID in top DTL on received DTL stack
 - If link previous to logical group node was cause of blocking:
 - blocked transit type = call or party blocked at succeeding end of interface
 - If cause of blocking was within logical group node:
 - blocked transit type = blocked node
 - blocked node ID = node ID of current transit in top DTL on receivedDTL stack
 - If link following logical group node was cause of blocking:
 - blocked transit type = blocked link
 - blocked link’s preceding node ID = node ID of current transit in top DTL on received DTL stack
 - blocked link’s port ID = port ID of current transit in top DTL on received DTL stack
 - blocked link’s succeeding node ID = target determined from received DTL stack (in step 4.b of DTL processing pseudocode), or all zeros if target is not a node

- b.1.2 No:
- crankback to next higher level in DTL stack **
 - crankback level = level of node ID in top DTL on received DTL stack
 - If link previous to logical group node was cause of blocking:
 - blocked transit type = call or party blocked at succeeding end of interface
 - If cause of blocking was within logical group node:
 - blocked transit type = blocked node
 - blocked node = node ID of current transit in top DTL on received DTL stack
 - If link following logical group node was cause of blocking:
 - blocked transit type = blocked ~~node~~link¹
 - blocked link's preceding node ID = node ID of current transit in top DTL on received DTL stack
 - blocked link's port ID = port ID of current transit in top DTL on received DTL stack
 - blocked link's succeeding node ID = next destination determined from received DTL stack (in step 4.b of DTL processing pseudocode), or all zeros if next destination is not a node

b.2 No: Progress crankback to previous interface

** Did at least one of the routing attempts get blocked at a link exiting the peer group (for which this node is an entry border node)?

b.1.2.1/b.1.1.2.1 yes: link exiting the peer group should be listed as blocked.

b.1.2.2/b.1.1.2.2 no: logical group node representing the peer group should be listed as blocked

8.4 Carrying Updated Topology State Parameters in Crankback information element

In many cases, blocking due to resource errors occurs due to the use of out-of-date or inaccurate values of routing parameters. In order to add up-to-date parameter values to the information contained in the originating or entry border node's topology database, the GCAC routing parameters specified in Sections 5.8.1.1.3.7, 5.8.1.1.3.8, and 5.8.1.1.3.9 can be optionally included as diagnostics for crankback cause #37, "user cell rate not available". This will allow for more effective routing of future call setups.

A node initiating crankback of a call may include updated GCAC parameter values as a diagnostic. Only updated parameter values for one direction are included, since each node is responsible for originating routing parameter values only for the outgoing direction on any given link. The updated GCAC parameters apply to the same service category as in the connection request. If AvCR, CRM, and VF are included, then complex GCAC applies (see Section 5.13.4.2). If only AvCR is specified, then simple GCAC applies (see Section 5.13.4.3).

For blocked links, the values to be included are the same values that would be advertised in a PTSE (or in a ULIA in Hellos for the upnode side of uplinks) if one were to be emitted at that instant in time. For blocked nodes, the values to be included are the same values that would be advertised in a PTSE as the default values for spokes in the complex node representation. For sake of discussion these values are referred to as the current values. The local node always has the best knowledge of its topology state parameters. The possibly out-of-date values in a given (remote) node's link state database will be referred to as the last advertised values.

When forming the Crankback information element with a Resource Error, the node initiating crankback of the call includes the relevant current values for the appropriate parameters. The last advertised values may or may not match the current values. The current values could be new/more accurate values which will be advertised in a PTSE to be emitted momentarily, after any holddown finishes. The current values may match the last advertised values in the most recently emitted PTSE which possibly "crossed in the mail" as the call progressed towards this node. The current values could be ones that will not be advertised until either some other more significant event occurs or the refresh timer fires.

In addition to the updated parameter values, a direction and port ID must be specified. For blocked nodes, the direction subfield is coded as "forward" and the port ID is coded as zero. For blocked links, the "forward" direction indicates that the call was blocked at the preceding side of a link, and the "backward" direction indicates that the call was blocked at the succeeding side of the link. If the direction is set to "forward", then the updated topology state parameters apply to the outgoing direction of the port specified by the port ID, from the blocked link's preceding node.

If the direction is set to "backward", then the port ID is set to zero by the node initiating crankback of the call. The updated parameter values are those values that apply to the physical link or VPC over which the SETUP or ADD PARTY message was received. When the preceding node receives the Crankback information element with the blocked transit type of "call or party has been blocked at the succeeding end of this interface"~~succeeding-end-blocked~~ indicator¹, it must insert a port ID that identifies its port for the PNNI interface. For uplinks, the updated parameter values apply to the incoming direction of the specified port on the blocked link's preceding node. For horizontal links, the updated parameter values apply to the outgoing direction on the corresponding port on the blocked link's succeeding node.

The port ID included with the updated topology state parameter values must be updated at each entry border node, whenever the call is cranked back to a new level of hierarchy. However, whenever the port is aggregated into another logical port (either at an entry border node or, for the case of blocking at the succeeding end of an uplink, possibly at the preceding node), then the updated parameter values and the port ID must either be replaced with values for the aggregate link or be discarded.

8.5 Triggering Significant Change Event for Resource Availability Information on Call Blocking³

This section proposes alternative procedures to Section 8.4 for handling call blocking due to inaccurate or out of date AvCR advertisements. These procedures are optional.

In most cases, blocking due to insufficient AvCR occurs when calls are routed based on out-of-date AvCR values last advertised by a node for a given topological entity (link, node, reachable addresses). This can occur normally as a result of flooding latency, but it can also occur as a result of either of the following:

- i) The current AvCR of the topological entity is at or below the upper "insignificant range" value calculated using AvCR_mT (i.e. AvCR_mT * MaxCR). Note that the smallest AvCR_mT value of 1% on an OC12 results in a range of insignificance of 0 – 6 Mbit/s. The default AvCR_mT of 3% on an OC12 results in a range of insignificance of 0 - 18 Mbit/s, and even 1% of an OC48 yields a range of insignificance of 0 – 24 Mbit/s. Or
- ii) AVCR PM is set too high on a node and therefore the range of insignificance is large compared to the amount of available bandwidth remaining. For example, if a node advertises an AvCR of 8Mbit/s for a link and uses an AvCR_PM of 50% (the default), then as long as the AvCR is between 4 & 12 Mbit/s, no event-triggered advertisement will occur. So, the bandwidth could actually be slightly above 4Mbit/s, but other nodes will continue to route calls up to 8Mbit/s toward that link. If these calls require more than 4 Mbit/s, these calls will block and crankback.

The following procedures provide an alternative to the mechanism specified in Section 8.4 when a call fails CAC due to out-of-date resource availability information. This mechanism allows for more effective routing of future call setups by making all nodes in the peer group aware of the up-to-date AvCR data for the resource that failed the call in CAC using PNNI routing. The mechanism is compatible with nodes not supporting it, since the procedures only specify another situation where existing flooding procedures can be triggered.

When a call fails CAC on a given topological entity, in addition to generating a crankback with crankback cause #37, "user cell rate not available", a node may generate a significant change event for a PTSE to advertise the up-to-date Resource availability information for the topological entity that failed the CAC. The event shall be generated only when:

1. The current AvCR on the topological entity that failed CAC is within the insignificant change range (as defined in Section 5.8.5.2.5.4), and
2. The call does not pass GCAC using the current AvCR on the topological entity for the call's service category (and therefore the call failed CAC and blocked), and
3. The call passes GCAC using the last advertised AvCR value for the call's service category for the topological entity that failed CAC (i.e. the call was routed toward a given resource because of the out-of-date information).

When the significant change event is generated as described in the above paragraph, the procedures of Section 5.8.5.2 shall be invoked (for example a new PTSE will be flooded, subject to PTSE hold down rules, and a new computation of the range of AvCR insignificance will occur).

The following figure depicts the mechanism specified above in the case of simple GCAC:

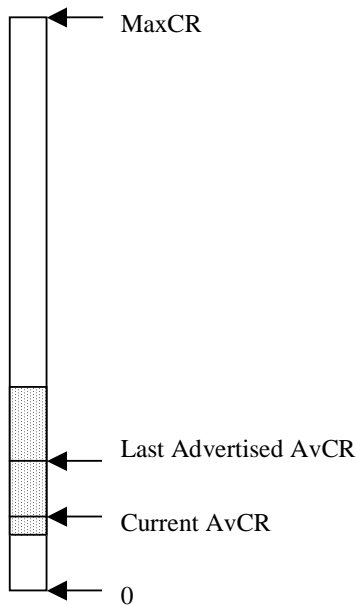

Legend:

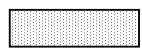
-  Resource's bandwidth
-  Insignificant AvCR change range based on the Last Advertised AvCR value

Call scenarios:

1. **Call request's bandwidth below or equal to the Current AvCR value**
Call is admitted. The optional procedures defined in this section do NOT apply.
2. **Call Request bandwidth above the Current AvCR value but below or equal to the Last Advertised AvCR value**
Call is rejected in CAC. The optional procedures defined in this section are invoked (i.e. a significant change event for PTSE is triggered and the procedures of section 5.8.5.2 are invoked).
3. **Call Request bandwidth above the Last Advertised AvCR value**
Call is rejected in CAC. The optional procedures defined in this section do NOT apply – Last Advertised AvCR value should make other nodes reject this call in GCAC.

Figure 8-1: Triggering a Significant Change Event on Call Blocking

9. Annex C: Soft Permanent Virtual Connection Procedures

This Annex describes the procedures for establishment of soft Permanent Virtual Connections which are established by management action. Both permanent virtual channel connection (PVCC) and permanent virtual path connections (PVPC) are supported at the PNNI.

~~Soft PVCs can connect endpoints of the same type. However, depending on the type of endpoint, either only Soft PVPCs, only Soft PVCCs or both Soft PVPCs and Soft PVCCs may be supported. For example both Soft PVPCs and Soft PVCCs can connect cell relay endpoints, while frame relay endpoints can only be connected by Soft PVCCs, corresponding to PVCCs can connect cell relay and/or frame relay endpoints, and PVPCs can connect cell relay endpoints only endpoints at the UNI. Soft PVCCs can be established between cell relay endpoints, frame relay endpoints or between a cell relay and frame relay endpoint³~~

~~Soft PVCs can also connect endpoints of different types including cell relay, frame relay and others. For example, a Soft PVCC can connect a cell relay end point with a frame relay endpoint. Note that The Soft PVCs can be originated from or terminated at either the cell or frame relay endpoint. Soft PVPCs can be established only between cell relay endpoints.³~~

These relationships are shown in the following table.⁴

Table 9-1: Soft PVC support of different endpoints types

<u>Connection Type</u>	<u>To/From Cell Relay Endpoint</u>	<u>To/From Frame Relay Endpoint</u>	<u>To/From Any Other Endpoint³</u>
<u>VCC</u>	<u>Supported</u>	<u>Supported</u>	<u>Supported (Note 1)</u>
<u>VPC</u>	<u>Supported</u>	<u>Not Supported</u>	<u>Supported (Note 1)</u>

~~Note 1 - When the called/calling party number identifies an interface that is not a cell relay or frame relay interface, the VPCI and VCI fields are virtual identifiers whose semantics are local to and are defined within the context of the called/calling party number. In such cases, these fields are not actual VPCIs and VCIs.³~~

~~A Soft PVPC/PVCC is established and released between the two network interfaces (NIs) serving the permanent virtual connection as a management action. The endpoints of a soft PVPC/PVCC Each interface where a Soft PVPC/PVCC endpoint is located are identified by assigning a unique ATM addresses including the SEL octet, in the case of a private ATM address (see Section 3.1 of UNI 4.0 signalling specification) to the corresponding NIs. The soft PVPC/PVCC is established between the two network interfaces. The NIs thus becomes the endpoints of the soft PVPC/PVCC.³~~

One of the two endpoints of a Soft PVPC/PVCC “owns” the Soft PVPC/PVCC and is responsible for establishing and releasing the connection. This network interface will be referred to as the calling endpoint. If the switched portion of the PVPC/PVCC gets disconnected because of switching system or link failure, it is also the responsibility of the calling endpoint to try to re-establish the connection. Frequency of re-establishment is an implementation option.

Before a Soft PVPC/PVCC can be established, there must be a means to uniquely identify the endpoints of the PVPC/PVCC. The identity of the network interface at the³ calling endpoint is encoded in the Calling Party number information element. The Called party of the Soft PVPC/PVCC identifies the network interface at the destination network node. The network management system provides the ATM addresses of the endpoints of a Soft PVPC/PVCC as well as information about the VPCI/VCI or frame relay DLCI⁴ values to be used at the two endpoints.

This Annex describes the signalling procedures for the establishment of point-to-point Soft PVPC/PVCCs and point-to-multipoint Soft PVPC/PVCCs. The procedures are the same as point-to-point and point-to-multipoint procedures for switched virtual connections with the following exceptions:

9.1 Messages

Section 6.3 applies.

~~The information elements AAL parameters, Broadband high layer information, Broadband low layer information, Called party subaddress, and Calling party subaddress information elements, which are used to carry end to end information are not included in the SETUP, CONNECT, ADD PARTY, and ADD PARTY ACK messages.~~³

9.2 Procedures for point-to-point Soft PVPC/PVCCs

The procedures of this Annex utilize the basic call/connection control procedures of Section 6.5. Additional procedures are described below.

Since the parameters of the PVPC or PVCC are established administratively, separate from the process that establishes the Soft PVPC/PVCC, negotiation of end to end parameters is not possible. The specific parameters that are not negotiable are: traffic parameters and QoS parameters. If any of these parameters as specified in the SETUP message cannot be supported by the switching system, the call shall be cranked back with cause and crankback cause #47, “Resources not available, unspecified”.

9.2.1 Initiating PVPC/PVCC establishment

The “owner” of the PVPC/PVCC connecting point shall initiate PVPC/PVCC establishment. A SETUP message shall be sent when the PVPC/PVCC is initially configured, or when the switching node which is the owner of the PVPC/PVCC becomes operational (e.g., power up), or during recovery from an outage.

A Bearer Class of VP or X is included in the Broadband bearer capability which identifies establishment of a VPC or a VCC, respectively, between the connecting points. ~~To identify the VPCI/VCI or frame relay DLCI of the PVPC/PVCC at the destination network node, the Called party Soft PVPC/PVCC information element, coded as shown in Figure 6-29 is shall be⁴ included in the SETUP message.~~ The Called party number information element shall contain the ~~configured peer PVPC/PVCC connecting point identifier~~address of the destination network interface, and the Calling party number information element shall contain the ~~PVPC/PVCC connecting point’s own identifier~~address of the originating network interface. ~~The Called party soft PVPC/PVCC information element identifying the PVPC/PVCC endpoint at the destination network interface (i.e. the VPCI or VPCI/VCI or DLCI fields) shall also be included in the SETUP message.~~³

~~When sending the Called or Calling party Soft PVPC/PVCC information element, the instruction flag field (bit 5 of octet 2) shall be set to “follow explicit instruction”, the action indicator (bits 1-3 of octet 2) shall be set to “clear call”, and the pass along request flag (bit 4 of octet 2) shall be set to “pass along request”.~~⁴

9.2.2 Receiving a CONNECT message at the calling NI

When the originating node receives a CONNECT message, it puts the PVPC/PVCC in an operational state. If the CONNECT message contains the Called party Soft PVPC/PVCC information element, the information identifying the VPCI or VPCI/VCI or DLCI⁴ values of the PVPC/PVCC segment between the called connecting point and the user (i.e. the VPCI or VPCI/VCI or DLCI fields)³ will be passed to the management entity.

9.2.3 Receiving a SETUP message at the called NI

When a SETUP message is received at the called connecting point, the procedures of Sections 6.5.2.4 and 6.5.2.6 shall apply. The called party number identifies the network interface serving ~~as the called~~ ~~connecting end~~point of the Soft PVPC/PVCC.

~~If the called party number identifies a ~~ee~~non frame relay network interface and the Called party Soft PVPC or PVCC information element specifies a DLCI, or the called party number identifies a frame relay network interface and the Called party Soft PVPC or PVCC information element specifies a VPCI/VCI, the call shall be cleared by sending a RELEASE or RELEASE COMPLETE message with cause #88 “incompatible destination”.~~⁴

9.2.3.1 Last PVPC segment ~~VPCI~~-allocation/selection

The procedures of this section apply to cell relay interfaces and non-cell relay interfaces other than frame relay interfaces. For non cell relay interfaces, the VPCI is used as an endpoint identifier within the non-cell relay interface and therefore does not necessarily represent a cell relay VPCI value. ³

The calling connecting point shall indicate one of the following for the called endpoint of Soft PVPCs:

- a) Any VPCI;
- b) Required VPCI.

In case a), the called connecting point selects any available VPCI. If no VPCI value is available, the call shall be cleared by sending a RELEASE or RELEASE COMPLETE message with ITU-T specific cause #34 "no circuit/channel available". If a VPCI value is specified in the Called party Soft PVPC/PVCC information element, the value shall be ignored. The selected VPCI value shall be returned in the Called party Soft PVPC/PVCC information element in the CONNECT message. The selection type field shall be coded as "assigned value".

In case b), if the indicated VPCI is available, the called connecting point selects it for the call. The Called party Soft PVPC/PVCC information element may be returned in the CONNECT message with the selection type field coded as "assigned value". If the VPCI is not available, a RELEASE or RELEASE COMPLETE message with PNNIATM Forum specific cause #34, "requested called party Soft PVPC/PVCC not available", shall be sent. If the Called party Soft PVPC/PVCC information element does not specify a VPCI, a RELEASE or RELEASE COMPLETE message with cause #100 "Invalid information element contents" shall be sent.

~~In case b), if the indicated VPI is available, the called connecting point selects it for the call. In case a), the called connecting point selects any available VPI.~~

~~The selected VPI value is indicated in the Called party soft PVPC/PVCC information element in the CONNECT message. The selection type field is coded as "assigned value".~~

~~In case b), if the VPI is not available, a RELEASE COMPLETE message with cause #34, "requested called party soft PVPC/PVCC not available", is sent.~~ ⁴

9.2.3.2 Last PVCC segment ~~VPCI/VCI~~-allocation/selection at non-frame relay interfaces

The procedures of this section apply to cell relay interfaces and non-cell relay interfaces other than frame relay interfaces. For non-cell relay interfaces, the combined VPCI/VCI is used as an endpoint identifier within the non-cell relay interface and therefore does not necessarily represent a cell relay VPCI/VCI value. ³

The calling connecting point shall indicate one of the following for the called endpoint of Soft PVCCs:

- a) Any VPCI; any VCI;
- b) Required VPCI; required VCI.

In case a), the called connecting point selects any available VPCI/VCI. If no VPCI/VCI value is available, the call shall be cleared by sending a RELEASE or RELEASE COMPLETE message with ITU-T specific cause #34, "no circuit/channel available". If a VPCI/VCI value is specified in the Called party Soft PVPC/PVCC information element, the value shall be ignored. The selected VPCI/VCI value shall be indicated in the Called party Soft PVPC/PVCC information element in the CONNECT message. The selection field shall be coded as "assigned value".

In case b), if the indicated VPCI/VCI is available, the called connecting point selects it for the call. The Called party Soft PVPC/PVCC information element may be returned in the CONNECT message with the selection type field coded as "assigned value". If the VPCI/VCI is not available, a RELEASE or RELEASE COMPLETE message with cause #34, "requested called party Soft PVPC/PVCC not available", shall be sent. If the Called party Soft PVPC/PVCC information element does not specify a VPCI/VCI, a RELEASE or RELEASE COMPLETE message with cause #100 "Invalid information element contents" shall be sent.

~~In case b), if the indicated VPI/VCI is available, the called connecting point selects it for the call. In case a), the called connecting point selects any available VPI/VCI.~~

The selected VPI/VCI value is indicated in the Called party soft PVPC/PVCC information element in the CONNECT message. The selection field is coded as "assigned value".

In case b), if the VPI/VCI is not available, a RELEASE COMPLETE message with cause #34, "requested called party soft PVPC/PVCC not available", is sent.⁴

9.2.3.3 Last ~~Frame Relay~~ PVCC segment ~~DLCI~~ allocation/selection at frame relay interfaces⁴

The calling connecting point shall indicate one of the following for the called endpoint of frame relay Soft PVCCs:

- a) Any DLCI;
- b) Required DLCI.

In case a), the called connecting point selects any available DLCI. If no DLCI value is available, the call shall be cleared by sending a RELEASE or RELEASE COMPLETE message with ITU-T specific cause #34 "no circuit/channel available". If a DLCI value is specified in the Called party Soft PVPC/PVCC information element, the value shall be ignored. The selected DLCI value shall be indicated in the Called party Soft PVPC/PVCC information element in the CONNECT message. The selection field shall be coded as "assigned value".

In case b), if the indicated DLCI is available, the called connecting point selects it for the call. The Called party Soft PVPC/PVCC information element may be returned in the CONNECT message with the selection type field coded as "assigned value". If the requested DLCI is not available, a RELEASE or RELEASE COMPLETE message with PNNI/ATM Forum specific cause #34 "requested called party Soft PVPC/PVCC not available" shall be sent. If the Called party Soft PVPC/PVCC information element does not specify a DLCI, a RELEASE or RELEASE COMPLETE message with cause #100 "Invalid information element contents" shall be sent.

9.3 Procedures for point-to-multipoint Soft PVPC/PVCCs

The procedures of this Annex utilize the Point-to-Multipoint call/connection control procedures of Section 6.6.

When sending the Called or Calling party Soft PVPC/PVCC information element, the instruction flag field (bit 5 of octet 2) shall be set to "follow explicit instruction", the action indicator (bits 1-3 of octet 2) shall be set to "clear call", and the pass along request flag (bit 4 of octet 2) shall be set to "pass along request".⁴

9.3.1 Adding a party at the originating interface

Connection establishment for point-to-multipoint Soft PVPC/PVCCs shall be initiated by the root connecting point. When the Soft PVPC/PVCC is initially configured, or a new party is added by network management, or when the switching node which is the root connecting point becomes operational (e.g., power up), or during recovery from an outage, a SETUP/ADD PARTY message shall be sent to one of the leaf connecting points³.

9.3.2 Set up of the first party

The set up of the first party of the soft point-to-multipoint PVPC/PVCC is always initiated by sending a SETUP message. A Bearer Class of VP or X is included in the Broadband bearer capability information element which identifies the establishment of a VPC or a VCC, respectively, between the connecting points. ~~To identify the VPCI/VCI value of the PVCC at the destination network node, the Called party Soft PVPC/PVCC information element is included in the SETUP message.~~ The Called party number information element shall contain the configured peer PVCC connecting point identifier address of the destination network interface, and the Calling party number information element shall contain the PVCC connecting point's own identifier address of the originating network interface. The Called party soft PVPC/PVCC information element identifying the PVPC/PVCC endpoint at the destination network interface (i.e. the VPCI or VPCI/VCI fields) shall also be included in the SETUP message.³

9.3.2.1 Receiving a CONNECT message at the calling NI

The procedures of Section 9.2.2 apply.

9.3.2.2 Receiving a SETUP message at the called NI

The procedures of Section 9.2.3 apply.

9.3.3 Adding a party

After the connection is established to the first leaf, connections shall be established to additional leaves. This shall be done by sending an ADD PARTY message for each leaf. ~~To identify the VPCI/VCI of the PVCC at the destination network node to the user, the Called party Soft PVPC/PVCC information element is included in the ADD PARTY message.~~ The Called party number information element shall contain the address of the destination network interface configured leaf PVCC connecting point identifier, and the Calling party number information element shall contain the address of the root network interface the root PVCC connecting point's own identifier. The Called party soft PVPC/PVCC information element identifying the PVPC/PVCC endpoint at the destination network interface (i.e. the VPCI or VPCI/VCI fields) shall also be included in the ADD PARTY message.³

9.3.3.1 Receiving an ADD PARTY ACKNOWLEDGE message at the calling NI

If the ADD PARTY ACKNOWLEDGE message contains the Called party Soft PVPC/PVCC information element, the information identifying VPCI/VCI values of the PVPC/PVCC segment between the called connecting point and the user (i.e. the information of the VPCI or VPCI/VCI fields)³ will be passed to the management entity.

9.3.3.2 Receiving an ADD PARTY message at the called NI

When an ADD PARTY message is received, the procedures of Section 6.6.2 shall apply. The called party number identifies the network interface serving as the called connecting point of the PVPC/PVCC.

9.3.3.2.1 Last PVCC segment ~~VPCI/VCI and Endpoint reference~~ allocation/selection

The procedures of this section apply to cell relay interfaces and non-cell relay interfaces. For non-cell relay interfaces, the combined VPCI/VCI is used as an endpoint identifier within the non-cell relay interface and therefore does not necessarily represent a cell relay VPCI/VCI value.³

The calling connecting point shall indicate one of the following for the called endpoint of the point-to-multipoint Soft PVCCs:

- a) Any VPCI; any VCI;
- b) Required VPCI; required VCI.

In case a), the called connecting point selects any available VPCI/VCI. If no VPCI/VCI value is available, the call shall be cleared by sending an ADD PARTY REJECT message with ITU-T specific cause #34, "no circuit/channel available". If a VPCI/VCI value is specified in the Called party Soft PVPC/PVCC information element, the value shall be ignored. The selected VPCI/VCI value shall be indicated in the Called party Soft PVPC/PVCC information element in the ADD PARTY ACK message. The selection field shall be coded as "assigned value".

In case b), if the indicated VPCI/VCI is available, the called connecting point selects it for the call. The Called party Soft PVPC/PVCC information element may be returned in the ADD PARTY ACK message with the selection type field coded as "assigned value". If the VPCI/VCI is not available, an ADD PARTY REJECT message with ~~PNNI~~ATM Forum specific cause #34, "requested called party Soft PVPC/PVCC not available" shall be sent. If the Called party Soft PVPC/PVCC information element does not specify a VPCI/VCI, an ~~ADD PARTY REJECT~~RELEASE COMPLETE message with cause #100 "Invalid information element contents" shall be sent.

~~In case b), if the indicated VPI/VCI is available, the called connecting point selects it for the call. In case a), the called connecting point selects any available VPI/VCI and endpoint reference.~~

~~The selected VPI/VCI value is indicated in the Called party soft PVPC/PVCC information element in the ADD PARTY ACK message. The selection field is coded as "assigned value".~~

~~In case b), if the VPI/VCI is not available, an ADD PARTY REJECT message with PNNI specific cause #34, "requested called party soft PVPC/PVCC not available", is sent.~~⁴

9.3.3.2.2 Last PVPC segment allocation/selection³

The procedures of this section apply to both cell relay and non-cell relay interfaces. For non-cell relay interfaces, the VPCI is used as an endpoint identifier within the non-cell relay interface and therefore does not necessarily represent a cell relay VPCI value.

The calling connecting point shall indicate one of the following for the called endpoint of the point-to-multipoint Soft PVPCs:

- a) Any value(s);
- b) Required VPCI.

In case a), the called connecting point selects any available VPCI. If no VPCI value is available, the call shall be cleared by sending an ADD PARTY REJECT message with ITU-T specific cause #34, "no circuit/channel available". If a VPCI value is specified in the Called party Soft PVPC/PVCC information element, the value shall be ignored. The selected VPCI value shall be indicated in the Called party Soft PVPC/PVCC information element in the ADD PARTY ACK message. The selection field shall be coded as "assigned value".

In case b), if the indicated VPCI is available, the called connecting point shall select it for the call. The Called party Soft PVPC/PVCC information element may be returned in the ADD PARTY ACK message with the selection type field coded as "assigned value". If the VPCI is not available, an ADD PARTY REJECT message with ATM Forum specific cause #34, "requested called party Soft PVPC/PVCC not available" shall be sent. If the Called party Soft PVPC/PVCC information element does not specify a VPCI value, an ADD PARTY REJECT message with cause #100 "Invalid information element contents" shall be sent.

9.4 Procedures at Intermediate Switches⁴

The following procedures shall apply at switches between the two Soft PVC endpoints.

If a Calling or Called party Soft PVPC/PVCC information element is received no content validation shall be performed on the information element, ~~other than verifying the maximum information element length. If the maximum length of the Calling or Called party soft PVPC/PVCC information element is exceeded, a RELEASE COMPLETE or ADD PARTY REJECT message as appropriate with cause #100 "Invalid information element contents" shall be returned.~~³

If the call is progressed, the received Calling or Called party Soft PVPC/PVCC information element shall be forwarded unchanged, ~~provided the next interface is PNNI~~³.

This allows for support of other endpoint types in the future, without having to upgrade intermediate nodes which do not support this other endpoint type.

9.5 Compatibility with PNNI 1.0 nodes not supporting af-cs-0127.000⁴

This section describes how this feature operates in a network containing PNNI 1.0 nodes that do not support af-cs-0127.000 [17].

PNNI 1.0 specifies that the high order four bits of the VPI field in Soft PVC information elements must be zero. PNNI nodes not supporting this feature might treat a received Soft PVC information element with a non-zero value in the high order four bits of the VPCI field as invalid contents (if a 12 bit value is enforced). Such a node would therefore reject the call as a result of having the action indicator (bits 1-3 of octet 2) set to “clear call”.

Use of the DLCI octet group in the Calling and Called party Soft PVPC and PVCC information elements to connect to or from a frame relay endpoint requires that all nodes along the path of the call which validate the content of these information elements support this feature. This is due to the fact that the Calling and Called Soft PVPC and PVCC information elements are already defined in PNNI 1.0. Hence addition of the DLCI octet group ~~defined in this addendum will~~ results in the information element being treated as a recognized information element with invalid contents.

Therefore, the Calling and Called Soft PVPC and PVCC information elements specifying a DLCI or a 16-bit VPCI shall be coded with the IE instruction flag field (bit 5 of octet 2) set to “follow explicit instruction”, the action indicator (bits 1-3 of octet 2) set to “clear call”, and the pass along request flag (bit 4 of octet 2) set to “pass along request”.

10. Annex D: Architectural Constants

These are the architectural constants defined by the PNNI specification.

DefaultAdminWeight = 5040.

This value was chosen for the following reasons:

- The number 5040 has the nice property of being divisible by 2, 3, 4, 5, 6, 7, 8, 9, 10, 12, 14, 15, 16, 18, 20, etc. This results in round numbers for administrative weights that are smaller than the default.
- This default value allows for increased numbers of multiple equal weight routes from a source to a destination when a range of administrative weights are used throughout a network.
- This number allows administrators flexibility in configuring administrative weights that are smaller than the default.

ExpiredAge = zero (0).

In a PTSE header, the value of PTSELifetime indicating that the PTSE has expired and should be removed from the topology database.

GroupLeaderIncrement = 50.

To allow for flexibility and stability, when a system concludes that it will be operating as peer group leader, it increments its advertised peer group leadership priority by GroupLeaderIncrement.

InitialSequenceNumber = one (1).

The first instance of all PTSEs is originated with this value as PTSESequenceNumber in the header.

MaxLeadership = 255.

The highest leadership priority for the PGL election protocol.

MaxSequenceNumber = $2^{32} - 1$.

In a PTSE header, the maximum value of PTSESequenceNumber.

OverloadRetryTime = 300 seconds.

The time interval between periodic database resynchronization attempts when a node is in topology database overload state.

RCCQoSClass = 0 (Unspecified QoS).

The QoS class for an RCC.

11. Annex E: Architectural Variables

These are the architectural variables used in the PNNI specification.

AvCR_PM: default value 50, allowed range 1 through 99.

The percentage of the last advertised Available Cell Rate such that a change within the range $AvCR \pm (AvCR * AvCR_PM / 100)$ is not considered significant.

AvCR_mT: default value 3, allowed range 1 through 99.

The percentage of maxCR such that changes in AvCR of less than that amount from the last advertised value are never considered significant, even when the rule for AvCR_PM would indicate that the change was significant.

CDV_PM: default value 25, allowed range 1 through 99.

The percentage of the last advertised Cell Delay Variation such that a change within the range $CDV \pm (CDV * CDV_PM / 100)$ is not considered significant.

ConfiguredLinkAggregationToken: default value 0.

The link aggregation token value that will be advertised in the Hello protocol.

DSRxmtInterval: default value 5 seconds.

The amount of time, in seconds, a node waits before it sends the previous Database Summary packet again.

HelloInterval: default value 15 seconds.

The amount of time in seconds between Hellos that a node sends on a link, in the absence of event-triggered Hellos.

HorizontalLinkInactivityTime: default value 120 seconds.

The amount of time in seconds a node will continue to advertise a horizontal link for which it has not received and processed the LGN horizontal link IG.

InactivityFactor: default value 5.

The number of HelloIntervals allowed to pass without receiving a Hello, before the Hellos FSM declares that a link is down.

InitialLGNSVCTimeout: default value 4 seconds.

The time interval to defer establishing an RCC SVCC so as to minimize the synchronization of multiple SETUPS to a new LGN.

maxCTD_PM: default value 50, allowed range 1 through 99.

The percentage of the last advertised Maximum Cell Transfer Delay such that a change within the range $maxCTD \pm (maxCTD * maxCTD_PM / 100)$ is not considered significant.

MaxTimeToFlush: default value 320 seconds.

The maximum amount of time to wait before the peer group leader attempts to flood the valid instance of a higher level PTSE into its peer group, after the peer group leader has proxy flushed an invalid instance of the same PTSE. This value is used when proxy flushing fails several times for the same PTSE.³

MinHelloInterval: default value 1 second; minimum value 0.1 seconds.

The minimum interval between successive Hello transmissions.

MinPTSEInterval: default value 1 second; minimum value 0.1 seconds.

The minimum interval between updates of any given PTSE. In other words, new instances of a PTSE can be issued no more often than every MinPTSEInterval seconds.

MinTimeToFlush: default value 40 seconds.

The initial amount of time to wait before the peer group leader attempts to flood the valid instance of a higher level PTSE into its peer group, after the peer group leader has proxy flushed an invalid instance of the same PTSE.³

OverrideDelay: default value 30 seconds.

In the PGL election, the amount of time that a node will wait for all nodes to agree on which node should be elected PGL.

PeerDelayedAckInterval: default value 1 second.

The minimum number of seconds between transmissions of delayed PTSE acknowledgment packets.

PGLInitTime: default value 15 seconds.

The initial value for the PGLInitTimer in the peer group leader election. The node delays specifying its choice for peer group leader until this timer has expired.

PTSELifetimeFactor: default value 200%.

This is used to calculate the initial lifetime of self originated PTSEs. The initial lifetime is set to the product of the PTSERefreshInterval and the PTSELifetimeFactor.

PTSERefreshInterval: default value 1800seconds.

This is the time in seconds between reoriginations of a self-originated PTSE in the absence of triggered updates. A node will reoriginate its PTSEs at this rate in order to prevent flushing of these PTSEs by other nodes.

PTSERetransmissionInterval: default value 5 seconds.

The interval at which unacknowledged PTSEs will be retransmitted. A PTSE will be retransmitted every PTSERetransmissionInterval seconds unless explicitly acknowledged through receipt of either a) an Acknowledgment Packet specifying the PTSE instance or b) the same instance or a more recent instance of the PTSE by flooding.

RCCMaximumBurstSize: default value 171 cells.

The maximum burst size requested for CLP=0+1 for both directions of an RCC.

RCCPeakCellRate: default value 906 cells per second.

The peak cell rate requested for CLP=0+1 for both directions of an RCC.

RCCSustainableCellRate: default value 453 cells per second.

The sustainable cell rate requested for CLP=0+1 for both directions of an RCC.

ReElectionInterval: default value 15 seconds.

The time interval a node waits before restarting the Peer Group Leader election process, after it discovers that it has no connectivity to the current PGL.

RequestRxmtInterval: default value 5 seconds.

The amount of time, in seconds, before a node sends a new PTSE Request Packet requesting PTSEs of the last PTSE Request Packet that have not been received yet.

RetryLGNSVCTimeout: default value 30 seconds.

The time interval to delay between a failed attempt to establish an RCC SVCC and a new SETUP for the same RCC SVCC.

SVCCalledIntegrityTime: default value 50 seconds.

The default value that is used to initialize the SVCIntegrityTimer at the node that accepts an LGN-LGN SVCC originated by a neighbor node.

SVCCallingIntegrityTime: default value 35 seconds.

The default value that is used to initialize the SVCIntegrityTimer at the node that initiates an LGN-LGN SVCC.

12. Annex F: Configuration of the PNNI Hierarchy

This Annex presents one preferred way of configuring the PNNI hierarchy. The PNNI MIB (see Annex H) allows one to configure the hierarchy in this manner. Additional methods of configuration are not precluded.

Each lowest level node in the PNNI hierarchy must know its own address, zero or more address summaries to advertise as reachable, its node ID, and the peer group ID.

The default level for a node is 96. The PNNI hierarchy is not necessarily of the same “depth” throughout any particular PNNI routing domain. Each lowest level peer group may therefore be configured, where appropriate, to have any level between 0 and 104.

Node IDs can be configured or defaulted using the method defined in Section 5.3.3.³

Peer group IDs may be configured or defaulted based on the level and node ID. The default value of a peer group ID has the first octet equal to the level, the next level bits equal to the level bits starting from the third octet of the node ID, and the remainder padded with zeros. If the level is configured, the peer group ID is a prefix of level bits on the node's address padded with trailing zero bits.³

Node IDs can also be defaulted based on level; see Section 5.3.3 for examples of how to do this.³

Configuration at the lowest level can therefore be simplified if all nodes in a peer group have been assigned addresses that start with the same 12 octet prefix, such that the 12 octet prefix is unique to that peer group. In this case the peer group ID and node ID do not need to be individually configured in each node. However it must be possible to configure lowest-level nodes to use other alternate peer group IDs and node IDs.

Each node must advertise reachability to those end systems that are reachable via that node. In some cases this may consist of a list of host addresses of every reachable host. However, in order to allow PNNI routing to scale, it is highly preferable to summarize host reachability by using a small set of address prefixes to represent reachability to multiple hosts. If a lowest level node has a level other than 104, it has a default summary address which is the 13 octet prefix of its node address. (This implies a presumption that these 13 octet prefixes are unique.) It must be possible to configure nodes to advertise other summary address prefixes either in addition to or instead of the default summary address.

Each node also needs to know the topology state parameters describing the characteristics of each link between that node and neighboring nodes, and the characteristics of the node itself. At the lowest level, it is permissible for these topology state parameters to default based on the physical characteristics of the links and node. At higher levels, these topology state parameters may be calculated based on the lower level links and nodes being aggregated.

Nodes that are not capable of being peer group leader (even at the lowest level of the hierarchy) do not need any additional configured information. Thus, the absolute minimum configuration information needed for such nodes is simply the address.

The peer group leader of each peer group must know the peer group ID of its parent peer group. Each node capable of being peer group leader must be configured to know its leadership priority, as well as its choice for the peer group ID of its parent peer group. Configuration of the higher level parent peer group ID may be done either by manual configuration of the entire ID or by manual configuration of a level. When only a level is configured the ID is a prefix of the lower-level peer group ID.

At a given level of the hierarchy, the PGL is instantiated in a switching system that also instantiates nodes acting as PGL of each descendant peer group in which that switching system participates. As a consequence of this, if such a node fails, it affects a large number of peer groups. This can be ameliorated by having a lowest-level node that exists at a higher level of the hierarchy, and has high PGL priority. Such a node can take over the duties of PGL from that level upwards.

Further detail of the configuration of each node is provided in the PNNI MIB specified in Annex H.

12.1 Considerations when using AESAs with embedded addresses³

If AESAs with embedded addresses for which the encoding defined in Section 5.2.2.1 is not used are assigned as PNNI node addresses, it is not recommended to use default generation of node IDs and peer group IDs.

13. Annex G: PNNI Minimum Subsets

This annex defines the minimum functional requirements for implementation of different subsets of a complete PNNI switching system. The four PNNI switching system subsets considered are as follows:

- Minimum function switching system - a switching system that is capable of supporting inside links in a multi-level PNNI hierarchy.
- PGL/LGN switching system - a switching system that is capable of instantiating LGNs.
- Border node capable switching system - a switching system that is capable of supporting outside links.
- Border node capable switching system with LGN peer support - a border node capable switching system whose lowest level nodes support being the peer of an LGN.

The border node and PGL/LGN subsets are extensions of the minimum function switching system subset. The border node with LGN peer support subset is an extension of the border node subset. This relationship is shown in Figure 13-1 below.

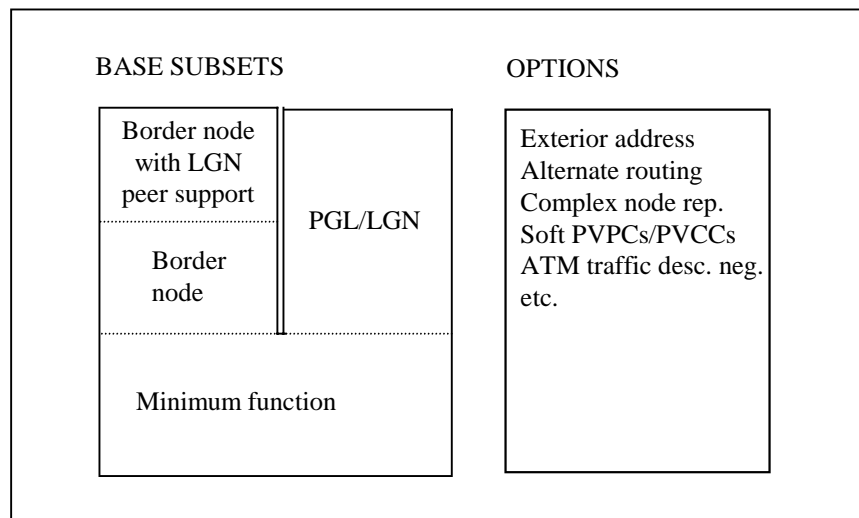

Figure 13-1: PNNI Minimum Subsets

All PNNI switching systems shall support the capabilities required of a minimum function switching system. All other capabilities are optional.

Table 13-1 below shows the ~~the~~ mandatory and optional capabilities corresponding to each of the different PNNI minimum subsets defined above.

Table 13-1: Mandatory and Optional Capabilities

No.	Capabilities	Switching System
1	Supports inside links	M
2	Version negotiation	M
3	Information group tags	M
4	Hello protocol over inside physical links	M
5	Database synchronization	M
6	Flooding	M
7	Understand all defined PTSE types	M
8	Origination of Nodal Information PTSEs	M
9	Origination of Horizontal Link PTSEs	M
10	Origination of Internal Reachable Address PTSEs	M
11	Vote in PGL elections	M

12	Perform default internal address summarization	M
13	Point-to-point Calls	M
14	Point-to-multipoint Calls	M
15	Signalling of Individual QoS Parameters	M
16	Notification of End-to-end Connection Completion	M ¹
17	ATM Anycast	M
18	Generate a Multi-level Designated Transit List	M
19	Follow a Multi-level DTL	M
20	Crankback	M(Note 1)
21	Outside link support	B
22	Hello protocol over outside links	B
23	Originate uplink PTSEs	B, P
24	Entry and exit border node DTL handling	B
25	Entry border node crankback handling	B
26	SVCC-based RCC	N, P
27	SVCC-based RCC Hello protocol	N, P
28	LGN horizontal link Hello protocol	N, P
29	PGL capable	P
30	Link aggregation	N, P
31	Nodal aggregation	P
32	Internal and Exterior address summarization	P
33	Origination of Exterior reachable address advertisement ¹	O
34	Alternate routing as a result of Crankback	O
35	Hello protocol over VPCs	O
36	Associated Signalling	O
37	Negotiation of ATM traffic descriptors	O
38	Switched Virtual Path (VP) service	O
39	Soft PVPC and PVCC support	O
40	ABR Signalling for Point-to-point Calls	O
41	Generic Identifier Transport	O
42	Frame Discard	O(Note 2)
43	ILMI over PNNI links	O

- M: Mandatory for all categories of switching systems (i.e. minimum function subset)
 B: Required for border node capable switching systems; otherwise optional
 N: Required for border node capable switching systems with peer LGN support; otherwise optional
 P: Required for PGL/LGN capable switching systems; otherwise optional
 O: Optional for all categories of switching systems

Note 1 - Support of alternate routing is optional.

Note 2 - Transport of the Frame Discard indication is mandatory.

Table 13-2 below lists additional optional capabilities of PNNI 1.1 which are specified in other ATM Forum specifications. When applicable, sub-features for the capabilities listed below are detailed in the associated specification.

In the specifications listed in Table 13-2, when PNNI 1.1 is supported, references to “PNNI 1.0” (af-pnni-0055.000), “PNNI ABR parameter negotiation addendum” (af-pnni-0075.000) or “PNNI 1.0 Errata and PICS” (af-pnni-0081.000) are replaced by a reference to this document.³

Table 13-2: Additional Optional PNNI 1.1 Capabilities³

No.	Capabilities	Specified In	Switching System
<u>44</u>	<u>Enhanced summarization of AESAs with embedded addresses.</u>	<u>Section 5.2.2.1</u>	<u>M</u>
<u>45</u>	<u>End-to-end Connection Completion Indication</u>	<u>Section 6.3.1.10</u>	<u>O</u>
<u>46</u>	<u>Triggering a Significant Change Event for Resource Availability Information on Call Blocking</u>	<u>Section 8.5</u>	<u>O</u>
<u>47</u>	<u>PNNI 1.1 support of administrative boundary</u>	<u>Annex Q</u>	<u>O</u>
<u>48</u>	<u>Enhanced Status Enquiry</u>	<u>Annex R</u>	<u>O</u>
<u>49</u>	<u>Explicitly Routed Calls</u>	<u>Annex S</u>	<u>O</u>
<u>50</u>	<u>OAM Traffic Descriptor</u>	<u>Annex T</u>	<u>O</u>
<u>51</u>	<u>PNNI/B-QSIG Interworking</u>	<u>af-cs-0102.000</u>	<u>O</u>
<u>52</u>	<u>Generic Support for Supplementary Services</u>	<u>af-cs-0102.000</u>	<u>O (Note 3)</u>
<u>53</u>	<u>PNNI Augmented Routing</u>	<u>af-ra-0104.000</u>	<u>O (Note 4)</u>
<u>54</u>	<u>Transported Address Stack</u>	<u>af-cs-0115.000</u>	<u>O</u>
<u>55</u>	<u>Security Signaling</u>	<u>af-cs-0116.000</u>	<u>O</u>
<u>56</u>	<u>Mobility extensions</u>	<u>af-ra-0123.000</u>	<u>O</u>
<u>57</u>	<u>Generic Application Transport</u>	<u>af-cs-0126.000</u>	<u>O</u>
<u>58</u>	<u>Soft PVC Frame Relay Endpoints</u>	<u>af-cs-0127.000 (Note 5)</u>	<u>O</u>
<u>59</u>	<u>Network Call Correlation Identifier</u>	<u>af-cs-0140.000</u>	<u>O</u>
<u>60</u>	<u>Path Trace</u>	<u>af-cs-0141.000</u>	<u>O</u>
<u>61</u>	<u>Connection Trace</u>	<u>af-cs-0141.000</u>	<u>O</u>
<u>62</u>	<u>UBR with MDCR</u>	<u>af-cs-0147.000</u>	<u>O</u>
<u>63</u>	<u>Modification of an Active Connection</u>	<u>af-cs-0148.001</u>	<u>O</u>
<u>64</u>	<u>Behavior Class Selector</u>	<u>af-cs-0159.000</u>	<u>O</u>
<u>65</u>	<u>Guaranteed Frame Rate (GFR) Signalling</u>	<u>af-cs-0167.000</u>	<u>O</u>
<u>66</u>	<u>PNNI Secure Routing</u>	<u>af-ra-0171.000</u>	<u>O</u>
<u>67</u>	<u>Domain-Based Rerouting</u>	<u>af-cs-0173.000</u>	<u>O</u>

Note 3 - Sub-capabilities within Generic Support for Supplementary Services are detailed in Annex O.

Note 4 - Sections 5 and 6 of the PNNI Augmented Routing specification define the Proxy PAR capability which is not applicable at a PNNI.

Note 5 - This specification supersedes specification af-cs-0127.000.³

14. Annex H: ~~The PNNI~~ Management Information Bases³**14.1 The Updated PNNI Management Information Base (as in af-pnni-0055.002.mib)**

```

PNNI-MIB DEFINITIONS ::= BEGIN

    IMPORTS
        MODULE-IDENTITY, OBJECT-TYPE, OBJECT-IDENTITY,
        Counter32, Gauge32, Integer32, Unsigned32, enterprises
            FROM SNMPv2-SMI
        TEXTUAL-CONVENTION, RowStatus, DisplayString,
        TimeStamp, TruthValue
            FROM SNMPv2-TC
        InterfaceIndex, ifIndex
            FROM IF-MIB
        AtmTrafficDescrParamIndex
            FROM ATM-MIB
        MODULE-COMPLIANCE, OBJECT-GROUP
            FROM SNMPv2-CONF;

pnniMIB MODULE-IDENTITY
    LAST-UPDATED      "200202110000Z"
    ORGANIZATION      "The ATM Forum"
    CONTACT-INFO
        "The ATM Forum
        Presidio of San Francisco
        P.O. Box 29920
        527B Ruger Street
        San Francisco, CA 94129-0920 USA
        Phone: +1 415-561-6275
        Fax: +1 415-561-6120
        info@atmforum.com"
    DESCRIPTION
        "The MIB module for managing ATM Forum PNNI routing."
    REVISION           "200202110000Z"
    DESCRIPTION
        "Updated version of the PNNI MIB for PNNI 1.1, adding
        objects for proxy flush and AESAs with embedded
        addresses (af-pnni-0055.002)."
```

```

    REVISION           "200102260000Z"
    DESCRIPTION
        "Updated version of the PNNI MIB adding support for the GFR
        ATM Service capability (af-cs-0167.000)."
```

```

    REVISION           "200006160000Z"
    DESCRIPTION
        "Updated version of the PNNI MIB adding support for the UBR
        with MDCR capability (af-cs-0147.000)."
```

```

    REVISION           "9810240000Z"
    DESCRIPTION
        "Updated version of the PNNI MIB released with the PNNI
        Addendum on PNNI/B-QSIG Interworking and Generic
        Functional Protocol for the Support of Supplementary
        Services (af-cs-0102.000)."
```

```

    REVISION           "9705010000Z"
    DESCRIPTION
        "Updated version of the PNNI MIB released with the PNNI
        V1.0 Errata and PICS (af-pnni-0081.000)."
```

```

    REVISION           "9602270000Z"
    DESCRIPTION

```

```
"Initial version of the MIB for monitoring and controlling
PNNI routing."
 ::= { atmFpnni 1 }

-- The object identifier subtree for ATM Forum PNNI MIBs

atmForum          OBJECT IDENTIFIER ::= { enterprises 353 }
atmForumNetworkManagement OBJECT IDENTIFIER ::= { atmForum 5 }
atmfPnni          OBJECT IDENTIFIER ::= { atmForumNetworkManagement 4 }

pnniMIBObjects OBJECT IDENTIFIER ::= { pnniMIB 1 }

PnniAtmAddr ::= TEXTUAL-CONVENTION
  STATUS          current
  DESCRIPTION
    "The ATM address used by the network entity.  The address
    types are: no address (0 octets), and NSAP (20 octets)."
```

REFERENCE

```
  "ATM Forum PNNI 1.1 Section 5.2"
  SYNTAX          OCTET STRING (SIZE(0|20))

PnniNodeIndex ::= TEXTUAL-CONVENTION
  STATUS          current
  DESCRIPTION
    "An index that identifies a logical PNNI entity within the
    managed system.

    The distinguished value zero indicates the null instance or
    no instance in the PnniNodeCfgParentNodeIndex.  In all
    other cases, the distinguished value zero indicates a
    logical entity within the switching system that manages
    routes only over non-PNNI interfaces.

    By default, only the node identified by node index one is
    created, and all PNNI interfaces are associated with that
    node."
  SYNTAX          Integer32 (0..65535)

PnniNodeId ::= TEXTUAL-CONVENTION
  STATUS          current
  DESCRIPTION
    "A PNNI node ID - this is used to identify the logical PNNI
    node."
  REFERENCE
    "ATM Forum PNNI 1.1 Section 5.3.3"
  SYNTAX          OCTET STRING (SIZE(22))

PnniPortId ::= TEXTUAL-CONVENTION
  STATUS          current
  DESCRIPTION
    "A PNNI port ID - this is used to identify a point of
    attachment of a logical link to a given logical node.

    The values 0 and 0xffffffff have special meanings in
    certain contexts and do not identify a specific port.
```

The distinguished value 0 indicates that no port is specified."

REFERENCE

"ATM Forum PNNI 1.1 Section 5.3.4"

SYNTAX Unsigned32

PnniAggrToken ::= TEXTUAL-CONVENTION

STATUS current

DESCRIPTION

"A PNNI aggregation token - this is used to determine which links to a given neighbor node are to be aggregated and advertised as a single logical link."

REFERENCE

"ATM Forum PNNI 1.1 Section 5.3.5"

SYNTAX Unsigned32

PnniPeerGroupId ::= TEXTUAL-CONVENTION

STATUS current

DESCRIPTION

"A PNNI peer group ID."

REFERENCE

"ATM Forum PNNI 1.1 Section 5.3.2"

SYNTAX OCTET STRING (SIZE(14))

PnniLevel ::= TEXTUAL-CONVENTION

STATUS current

DESCRIPTION

"A PNNI routing level indicator."

REFERENCE

"ATM Forum PNNI 1.1 Section 5.3.1"

SYNTAX Integer32 (0..104)

PnniSvccRccIndex ::= TEXTUAL-CONVENTION

STATUS current

DESCRIPTION

"The value of this object identifies the SVCC-based RCC for which the entry contains management information."

SYNTAX Integer32

AtmAddrPrefix ::= TEXTUAL-CONVENTION

STATUS current

DESCRIPTION

"A prefix of one or more ATM End System Addresses. The significant portion of a prefix is padded with zeros on the right to fill 19 octets."

REFERENCE

"ATM Forum PNNI 1.1 Section 5.2"

SYNTAX OCTET STRING (SIZE(19))

PnniPrefixLength ::= TEXTUAL-CONVENTION

STATUS current

DESCRIPTION

"The number of bits that are significant in an ATM address prefix used by PNNI."

REFERENCE

```
"ATM Forum PNNI 1.1 Section 5.2"
SYNTAX      Integer32 (0..152)

PnniMetricsTag ::= TEXTUAL-CONVENTION
STATUS      current
DESCRIPTION
  "An index into the pnniMetricsTable. The suffix tag is used
  to indicate that there may be many related entries in the
  table further discriminated by other index terms. The
  distinguished value zero indicates that no metrics are
  associated with the described entity."
SYNTAX      Integer32 (0..2147483647)

ServiceCategory ::= TEXTUAL-CONVENTION
STATUS      current
DESCRIPTION
  "Indicates the service category."
REFERENCE
  "ATM Forum Traffic Management 4.1 Section 2"
SYNTAX      INTEGER { other(1),
                      cbr(2),
                      rtVbr(3),
                      nrtVbr(4),
                      abr(5),
                      ubr(6),
                      gfr(7) }

ClpType ::= TEXTUAL-CONVENTION
STATUS      current
DESCRIPTION
  "Indicates the CLP type of a traffic stream."
SYNTAX      INTEGER { clpEqual0(1), clpEqual0Or1(2) }

TnsType ::= TEXTUAL-CONVENTION
STATUS      current
DESCRIPTION
  "Indicates the type of network identification of a
  specified transit network."
REFERENCE
  "ATM Forum UNI Signalling 4.1 Section 2 4.5.22/Q.2931"
SYNTAX      INTEGER { nationalNetworkIdentification(2),
                      other(8) }

TnsPlan ::= TEXTUAL-CONVENTION
STATUS      current
DESCRIPTION
  "Indicates the network identification plan of a
  specified transit network."
REFERENCE
  "ATM Forum UNI Signalling 4.1 Section 2 4.5.22/Q.2931"
SYNTAX      INTEGER { carrierIdentificationCode(1),
                      other(16) }

PnniVersion ::= TEXTUAL-CONVENTION
STATUS      current
DESCRIPTION
```

```

    "Indicates a version of the PNNI protocol."
REFERENCE
    "ATM Forum PNNI 1.1 Section 5.6.1"
SYNTAX      INTEGER { unsupported(1), version1point0(2) }

PnniHelloState ::= TEXTUAL-CONVENTION
    STATUS      current
    DESCRIPTION
        "The state of an instance of the PNNI Hello State machine."
REFERENCE
    "ATM Forum PNNI 1.1 Section 5.6.2.1.2"
SYNTAX      INTEGER {
        notApplicable(1),
        down(2),
        attempt(3),
        oneWayInside(4),
        twoWayInside(5),
        oneWayOutside(6),
        twoWayOutside(7),
        commonOutside(8)
    }

GfrCapability ::= TEXTUAL-CONVENTION
    STATUS      current
    DESCRIPTION
        "Indicates the GFR conformance definitions supported."
REFERENCE
    "ATM Forum Traffic Management 4.1 Section 2"
SYNTAX      INTEGER { gfrDot1(1),
        gfrDot2(2),
        gfrDot1AndGfrDot2(3) }

zeroDotZero   OBJECT-IDENTITY
    STATUS      current
    DESCRIPTION
        "A value used for null identifiers.

        This definition, which is in compliance with RFC 1902, is a
        temporary inclusion in the PNNI MIB until such time as MIB
        compilers are upgraded and thereby can accept references to
        the new definitions in RFC 1902."
REFERENCE
    "RFC 1902"
    ::= { 0 0 }

-- the base group

pnniBaseGroup OBJECT IDENTIFIER ::= { pnniMIBObjects 1 }

pnniHighestVersion OBJECT-TYPE
    SYNTAX      PnniVersion
    MAX-ACCESS  read-only
    STATUS      current
    DESCRIPTION
        "The highest version of the PNNI protocol that the
        software in this switching system is capable of executing."
REFERENCE
    "ATM Forum PNNI 1.1 Section 5.6.1"

```



```
 ::= { pnniBaseGroup 1 }

pnniLowestVersion OBJECT-TYPE
    SYNTAX      PnniVersion
    MAX-ACCESS  read-only
    STATUS      current
    DESCRIPTION
        "The lowest version of the PNNI Protocol that the
         software in this switching system is capable of executing."
    REFERENCE
        "ATM Forum PNNI 1.1 Section 5.6.1"
 ::= { pnniBaseGroup 2 }

pnniDtlCountOriginator OBJECT-TYPE
    SYNTAX      Counter32
    MAX-ACCESS  read-only
    STATUS      current
    DESCRIPTION
        "The total number of DTL stacks that this switching system
         has originated as the DTLOriginator and placed into
         signalling messages. This includes the initial DTL stacks
         computed by this system as well as any alternate route
         (second, third choice etc.) DTL stacks computed by this
         switching system in response to crankbacks."
 ::= { pnniBaseGroup 3 }

pnniDtlCountBorder OBJECT-TYPE
    SYNTAX      Counter32
    MAX-ACCESS  read-only
    STATUS      current
    DESCRIPTION
        "The number of partial DTL stacks that this switching system
         has added into signalling messages as an entry border node.
         This includes the initial partial DTL stacks computed by
         this system as well as any alternate route (second, third
         choice etc.) partial DTL stacks computed by this switching
         system in response to crankbacks."
 ::= { pnniBaseGroup 4 }

pnniCrankbackCountOriginator OBJECT-TYPE
    SYNTAX      Counter32
    MAX-ACCESS  read-only
    STATUS      current
    DESCRIPTION
        "The count of the total number of connection setup messages
         including DTL stacks originated by this switching system
         that have cranked back to this switching system at all
         levels of the hierarchy."
 ::= { pnniBaseGroup 5 }

pnniCrankbackCountBorder OBJECT-TYPE
    SYNTAX      Counter32
    MAX-ACCESS  read-only
    STATUS      current
    DESCRIPTION
        "The count of the total number of connection setup messages
         including DTLs added by this switching system as an entry
         border node that have cranked back to this switching system
         at all levels of the hierarchy. This count does not include
         Crankbacks for which this switching system was not the
         crankback destination, only those crankbacks that were
```

```
    directed to this switching system are counted here."  
 ::= { pnniBaseGroup 6 }
```

pnniAltRouteCountOriginator OBJECT-TYPE

```
SYNTAX          Counter32  
MAX-ACCESS      read-only  
STATUS          current  
DESCRIPTION  
    "The total number of alternate DTL stacks that this  
    switching system has computed and placed into  
    signalling messages as the DTLOriginator."  
 ::= { pnniBaseGroup 7 }
```

pnniAltRouteCountBorder OBJECT-TYPE

```
SYNTAX          Counter32  
MAX-ACCESS      read-only  
STATUS          current  
DESCRIPTION  
    "The total number of alternate partial DTL stacks that this  
    switching system has computed and placed into signalling  
    messages as an entry border node."  
 ::= { pnniBaseGroup 8 }
```

pnniRouteFailCountOriginator OBJECT-TYPE

```
SYNTAX          Counter32  
MAX-ACCESS      read-only  
STATUS          current  
DESCRIPTION  
    "The total number of times where the switching system failed  
    to compute a viable DTL stack as the DTLOriginator for some  
    call. It indicates the number of times a call was cleared  
    from this switching system due to originator routing  
    failure."  
 ::= { pnniBaseGroup 9 }
```

pnniRouteFailCountBorder OBJECT-TYPE

```
SYNTAX          Counter32  
MAX-ACCESS      read-only  
STATUS          current  
DESCRIPTION  
    "The total number of times where the switching system failed  
    to compute a viable partial DTL stack as an entry border  
    node for some call. It indicates the number of times a  
    call was either cleared or cranked back from this switching  
    system due to border routing failure."  
 ::= { pnniBaseGroup 10 }
```

pnniRouteFailUnreachableOriginator OBJECT-TYPE

```
SYNTAX          Counter32  
MAX-ACCESS      read-only  
STATUS          current  
DESCRIPTION  
    "The total number of times where the switching system failed  
    to compute a viable DTL stack as the DTLOriginator because  
    the destination was unreachable, i.e., those calls that are  
    cleared with cause #2 `specified transit network  
    unreachable' or cause #3 `destination unreachable' in the  
    cause IE."  
 ::= { pnniBaseGroup 11 }
```

pnniRouteFailUnreachableBorder OBJECT-TYPE

```

SYNTAX          Counter32
MAX-ACCESS      read-only
STATUS          current
DESCRIPTION
    "The total number of times where the switching system failed
    to compute a viable partial DTL stack as an entry border
    node because the target of the path calculation was
    unreachable, i.e., those calls that are cleared or cranked
    back with cause #2 `specified transit network unreachable'
    or cause #3 `destination unreachable' in the cause IE."
 ::= { pnniBaseGroup 12 }

-- node table

pnniNodeTable OBJECT-TYPE
    SYNTAX          SEQUENCE OF PnniNodeEntry
    MAX-ACCESS      not-accessible
    STATUS          current
    DESCRIPTION
        "The pnniNodeTable collects attributes that affect the
        operation of a PNNI logical node.

        There is a single row in this table for each PNNI peer
        group that the managed system is expected or eligible
        to become a member of."
    REFERENCE
        "ATM Forum PNNI 1.1 Annex F"
    ::= { pnniMIBObjects 2 }

pnniNodeEntry OBJECT-TYPE
    SYNTAX          PnniNodeEntry
    MAX-ACCESS      not-accessible
    STATUS          current
    DESCRIPTION
        "An entry in the table, containing information about a PNNI
        logical node in this switching system."
    REFERENCE
        "ATM Forum PNNI 1.1 Annex F"
    INDEX          { pnniNodeIndex }
    ::= { pnniNodeTable 1 }

PnniNodeEntry ::=
    SEQUENCE {
        pnniNodeIndex          PnniNodeIndex,
        pnniNodeLevel          PnniLevel,
        pnniNodeId             PnniNodeId,
        pnniNodeLowest         TruthValue,
        pnniNodeAdminStatus    INTEGER,
        pnniNodeOperStatus     INTEGER,
        pnniNodeDomainName     DisplayString,
        pnniNodeAtmAddress      PnniAtmAddr,
        pnniNodePeerGroupId     PnniPeerGroupId,
        pnniNodeRestrictedTransit TruthValue,
        pnniNodeComplexRep      TruthValue,
        pnniNodeRestrictedBranching TruthValue,
        pnniNodeDatabaseOverload TruthValue,
        pnniNodePtses          Gauge32,
        pnniNodeRowStatus       RowStatus,
        pnniNodeCoBiTransportSupported TruthValue,
        pnniNodeClBiTransportSupported TruthValue,

```

```

    pnniNodeEmbedAddrAESAPrefixAdvType    INTEGER
  }

```

pnniNodeIndex OBJECT-TYPE

```

SYNTAX      PnniNodeIndex
MAX-ACCESS  not-accessible
STATUS      current
DESCRIPTION
    "A value assigned to a node in this switching system that
    uniquely identifies it in the MIB."
 ::= { pnniNodeEntry 1 }

```

pnniNodeLevel OBJECT-TYPE

```

SYNTAX      PnniLevel
MAX-ACCESS  read-create
STATUS      current
DESCRIPTION
    "The level of PNNI hierarchy at which this node exists. This
    attribute is used to determine the default node ID and the
    default peer group ID for this node. This object may only
    be written when pnniNodeAdminStatus has the value down."
REFERENCE
    "ATM Forum PNNI 1.1 Section 5.3.1, Annex F"
DEFVAL { 96 }
 ::= { pnniNodeEntry 2 }

```

pnniNodeId OBJECT-TYPE

```

SYNTAX      PnniNodeId
MAX-ACCESS  read-create
STATUS      current
DESCRIPTION
    "The value the switching system is using to represent
    itself as this node. This object may only be written when
    pnniNodeAdminStatus has the value down.

    If pnniNodeLowest is true, then the default node ID takes
    the form defined in Section 5.3.3 for lowest level nodes,
    with the first octet equal to pnniNodeLevel, the second
    octet equal to 160, and the last 20 octets equal to
    pnniNodeAtmAddress. However if the pnniNodeAtmAddress
    contains an AESA with an AFI indicating the presence of
    embedded addresses and the value of
    pnniNodeEmbedAddrAESAPrefixAdvType is 'leftJustified',
    then the last 20 octets are set to the left justified
    form of pnniNodeAtmAddress as described in section
    5.2.2.1.

    If pnniNodeLowest is false, then the default
    node ID takes the form defined in Section 5.3.3 for logical
    group nodes, with the first octet equal to pnniNodeLevel,
    the next fourteen octets equal to the value of
    pnniNodePeerGroupId for the child node whose election as
    PGL causes this LGN to be instantiated, the next six octets
    equal to the ESI of pnniNodeAtmAddress, and the last octet
    equal to zero."
REFERENCE
    "ATM Forum PNNI 1.1 Sections 5.3.3 and 5.2.2.1, Annex F"
 ::= { pnniNodeEntry 3 }

```

pnniNodeLowest OBJECT-TYPE

```

SYNTAX      TruthValue

```

```

MAX-ACCESS      read-create
STATUS          current
DESCRIPTION
    "Indicates whether this node acts as a lowest level node or
    whether this node is a logical group node that becomes
    active when one of the other nodes in this switching system
    becomes a peer group leader. The value 'false' must not be
    used with nodes that are not PGL/LGN capable.

    This object may only be
    written when pnniNodeAdminStatus has the value down."
DEFVAL { true }
 ::= { pnniNodeEntry 4 }

```

```

pnniNodeAdminStatus OBJECT-TYPE
SYNTAX          INTEGER { up(1), down(2) }
MAX-ACCESS      read-create
STATUS          current
DESCRIPTION
    "Indicates whether the administrative status of the node is
    up (the node is allowed to become active) or down (the node
    is forced to be inactive).

    When pnniNodeAdminStatus is down, then pnniNodeOperStatus
    must also be down."
DEFVAL { up }
 ::= { pnniNodeEntry 5 }

```

```

pnniNodeOperStatus OBJECT-TYPE
SYNTAX          INTEGER { up(1), down(2) }
MAX-ACCESS      read-only
STATUS          current
DESCRIPTION
    "Indicates whether the node is active or whether the node
    has yet to become operational. When the value is down, all
    state has been cleared from the node and the node is not
    communicating with any of its neighbor nodes."
 ::= { pnniNodeEntry 6 }

```

```

pnniNodeDomainName OBJECT-TYPE
SYNTAX          DisplayString
MAX-ACCESS      read-create
STATUS          current
DESCRIPTION
    "The name of the PNNI routing
    domain in which this node participates. All lowest-level
    PNNI nodes with the same pnniNodeDomainName are presumed to
    be connected."
DEFVAL { "" }
 ::= { pnniNodeEntry 7 }

```

```

pnniNodeAtmAddress OBJECT-TYPE
SYNTAX          PnniAtmAddr
MAX-ACCESS      read-create
STATUS          current
DESCRIPTION
    "This node's ATM End System Address. Remote systems wishing
    to exchange PNNI protocol packets with this node should
    direct packets or calls to this address.

    This attribute may only be written when pnniNodeAdminStatus

```

has the value down."

REFERENCE
 "ATM Forum PNNI 1.1 Section 5.2.2"
 ::= { pnniNodeEntry 8 }

pnniNodePeerGroupId OBJECT-TYPE
 SYNTAX PnniPeerGroupId
 MAX-ACCESS read-create
 STATUS current
 DESCRIPTION
 "The Peer Group Identifier of the peer group that the given node is to become a member of.

 The default value of this attribute has the first octet equal to pnniNodeLevel, the next pnniNodeLevel bits equal to the pnniNodeLevel bits starting from the third octet of pnniNodeId, and the remainder padded with zeros.

 This object may only be written when pnniNodeAdminStatus has the value down."
 REFERENCE
 "ATM Forum PNNI 1.1 Section 5.3.2, Annex F"
 ::= { pnniNodeEntry 9 }

pnniNodeRestrictedTransit OBJECT-TYPE
 SYNTAX TruthValue
 MAX-ACCESS read-create
 STATUS current
 DESCRIPTION
 "Specifies whether the node is restricted to not allowing support of SVCs transiting this node. This attribute determines the setting of the restricted transit bit in the nodal information group originated by this node."
 REFERENCE
 "ATM Forum PNNI 1.1 Section 5.8.1.2.3"
 DEFVAL { false }
 ::= { pnniNodeEntry 10 }

pnniNodeComplexRep OBJECT-TYPE
 SYNTAX TruthValue
 MAX-ACCESS read-create
 STATUS current
 DESCRIPTION
 "Specifies whether this node uses the complex node representation. A value of `true` indicates that the complex node representation is used, whereas a value of `false` indicates that the simple node representation is used. This attribute determines the setting of the nodal representation bit in the nodal information group originated by this node."
 REFERENCE
 "ATM Forum PNNI 1.1 Section 5.8.1.2.3"
 ::= { pnniNodeEntry 11 }

pnniNodeRestrictedBranching OBJECT-TYPE
 SYNTAX TruthValue
 MAX-ACCESS read-only
 STATUS current
 DESCRIPTION
 "Indicates whether the node is able to support additional point-to-multipoint branches. A value of `false` indicates

that additional branches can be supported, and a value of 'true' indicates that additional branches cannot be supported. This attribute reflects the setting of the restricted branching bit in the nodal information group originated by this node."

REFERENCE

"ATM Forum PNNI 1.1 Section 5.8.1.2.3"

::= { pnniNodeEntry 12 }

pnniNodeDatabaseOverload OBJECT-TYPE

SYNTAX TruthValue

MAX-ACCESS read-only

STATUS current

DESCRIPTION

"Specifies whether the node is currently operating in topology database overload state. This attribute has the same value as the Non-transit for PGL Election bit in the nodal information group originated by this node."

REFERENCE

"ATM Forum PNNI 1.1 Section 5.8.1.2.3"

::= { pnniNodeEntry 13 }

pnniNodePtses OBJECT-TYPE

SYNTAX Gauge32

MAX-ACCESS read-only

STATUS current

DESCRIPTION

"Gauges the total number of PTSEs currently in this node's topology database(s)."

::= { pnniNodeEntry 14 }

pnniNodeRowStatus OBJECT-TYPE

SYNTAX RowStatus

MAX-ACCESS read-create

STATUS current

DESCRIPTION

"To create, delete, activate and de-activate a Node."

::= { pnniNodeEntry 15 }

pnniNodeCoBiTransportSupported OBJECT-TYPE

SYNTAX TruthValue

MAX-ACCESS read-create

STATUS current

DESCRIPTION

"Specifies whether the node supports CO-BI transport as part of generic support for supplementary services (see Annex L). This attribute determines the setting of the CO-BI transport supported bit in the nodal information group originated by this node."

REFERENCE

"ATM Forum PNNI 1.1 Section 5.8.1.2.3 as amended by Part 2 of PNNI Addendum on PNNI/B-QSIG Interworking and Generic Functional Protocol for the Support of Supplementary Services"

::= { pnniNodeEntry 16 }

pnniNodeClBiTransportSupported OBJECT-TYPE

SYNTAX TruthValue

MAX-ACCESS read-create

STATUS current

DESCRIPTION

"Specifies whether the node supports CL-BI transport as part of generic support for supplementary services (see Annex L). This attribute determines the setting of the CL-BI transport supported bit in the nodal information group originated by this node."

REFERENCE

"ATM Forum PNNI 1.1 Section 5.8.1.2.3 as amended by Part 2 of PNNI Addendum on PNNI/B-QSIG Interworking and Generic Functional Protocol for the Support of Supplementary Services"

::= { pnniNodeEntry 17 }

pnniNodeEmbedAddrAESAPrefixAdvType OBJECT-TYPE

SYNTAX INTEGER {
 rightJustified(1),
 leftJustified(2)
 }

MAX-ACCESS read-create

STATUS current

DESCRIPTION

"Indicates in which format address prefixes shall be advertised for AESAs using AFIs indicating the presence of Embedded Addresses. The value 'rightJustified' indicates the deprecated format used in PNNI 1.0, while the value 'leftJustified' format means that all leading semi-octets '0000' within the IDI are deleted as specified in PNNI 1.1 section 5.2.2.1."

REFERENCE

"ATM Forum PNNI 1.1 Section 5.2.2.1"

::= { pnniNodeEntry 18 }

-- PGL election table

pnniNodePglTable OBJECT-TYPE

SYNTAX SEQUENCE OF PnniNodePglEntry

MAX-ACCESS not-accessible

STATUS current

DESCRIPTION

"Peer group leader election information for a PNNI node in this switching system."

REFERENCE

"ATM Forum PNNI 1.1 Section 5.10.1"

::= { pnniMIBObjects 3 }

pnniNodePglEntry OBJECT-TYPE

SYNTAX PnniNodePglEntry

MAX-ACCESS not-accessible

STATUS current

DESCRIPTION

"An entry in the table, containing PGL election information of a PNNI logical node in this switching system."

REFERENCE

"ATM Forum PNNI 1.1 Section 5.10.1"

AUGMENTS { pnniNodeEntry }

::= { pnniNodePglTable 1 }

PnniNodePglEntry ::=

SEQUENCE {
 pnniNodePglLeadershipPriority INTEGER,
 pnniNodeCfgParentNodeIndex PnniNodeIndex,
 pnniNodePglInitTime Integer32,

pnniNodePglOverrideDelay	Integer32,
pnniNodePglReelectTime	Integer32,
pnniNodePglState	INTEGER,
pnniNodePreferredPgl	PnniNodeId,
pnniNodePeerGroupLeader	PnniNodeId,
pnniNodePglTimeStamp	TimeStamp,
pnniNodeActiveParentNodeId	PnniNodeId
}	

pnniNodePglLeadershipPriority OBJECT-TYPE

SYNTAX INTEGER (0..205)

MAX-ACCESS read-create

STATUS current

DESCRIPTION

"The Leadership priority value this node should advertise in its nodal information group for the given peer group. Only the value zero can be used with nodes that are not PGL/LGN capable. If there is no configured parent node index or no corresponding entry in the pnniNodeTable, then the advertised leadership priority is zero regardless of this value."

REFERENCE

"ATM Forum PNNI 1.1 Section 5.10.1.2"

DEFVAL { 0 }

::= { pnniNodePglEntry 1 }

pnniNodeCfgParentNodeId OBJECT-TYPE

SYNTAX PnniNodeId

MAX-ACCESS read-create

STATUS current

DESCRIPTION

"The local node index used to identify the node that will represent this peer group at the next higher level of hierarchy, if this node becomes peer group leader. The value 0 indicates that there is no parent node."

REFERENCE

"ATM Forum PNNI 1.1 Annex F"

DEFVAL { 0 }

::= { pnniNodePglEntry 2 }

pnniNodePglInitTime OBJECT-TYPE

SYNTAX Integer32

UNITS "seconds"

MAX-ACCESS read-create

STATUS current

DESCRIPTION

"The amount of time in seconds this node will delay advertising its choice of preferred PGL after having initialized operation and reached the full state with at least one neighbor in the peer group."

REFERENCE

"ATM Forum PNNI 1.1 Annex E PGLInitTime"

DEFVAL { 15 }

::= { pnniNodePglEntry 3 }

pnniNodePglOverrideDelay OBJECT-TYPE

SYNTAX Integer32

UNITS "seconds"

MAX-ACCESS read-create

STATUS current

DESCRIPTION

"The amount of time in seconds a node will wait for itself to be declared the preferred PGL by unanimous agreement among its peers. In the absence of unanimous agreement this will be the amount of time that will pass before this node considers a two thirds majority as sufficient agreement to declare itself peer group leader, abandoning the attempt to get unanimous agreement."

REFERENCE

"ATM Forum PNNI 1.1 Annex E OverrideDelay"

DEFVAL { 30 }

::= { pnniNodePglEntry 4 }

pnniNodePglReelectTime OBJECT-TYPE

SYNTAX Integer32

UNITS "seconds"

MAX-ACCESS read-create

STATUS current

DESCRIPTION

"The amount of time in seconds after losing connectivity to the current peer group leader, that this node will wait before re-starting the process of electing a new peer group leader."

REFERENCE

"ATM Forum PNNI 1.1 Annex E ReElectionInterval"

DEFVAL { 15 }

::= { pnniNodePglEntry 5 }

pnniNodePglState OBJECT-TYPE

SYNTAX INTEGER {
starting(1),
awaiting(2),
awaitingFull(3),
initialDelay(4),
calculating(5),
awaitUnanimity(6),
operPgl(7),
operNotPgl(8),
hungElection(9),
awaitReElection(10)
}

MAX-ACCESS read-only

STATUS current

DESCRIPTION

"Indicates the state that this node is in with respect to the Peer Group Leader election that takes place in the node's peer group. The values are enumerated in the Peer Group Leader State Machine."

REFERENCE

"ATM Forum PNNI 1.1 Section 5.10.1.1.2"

::= { pnniNodePglEntry 6 }

pnniNodePreferredPgl OBJECT-TYPE

SYNTAX PnniNodeId

MAX-ACCESS read-only

STATUS current

DESCRIPTION

"The Node ID of the node which the local node believes should be or become the peer group leader. This is also the value the local node is currently advertising in the 'Preferred Peer Group Leader Node ID' field of its nodal information group within

the given peer group. If a Preferred PGL has not been chosen, this attribute's value is set to (all) zero(s)."

REFERENCE

"ATM Forum PNNI 1.1 Section 5.10.1.1.6"

::= { pnniNodePglEntry 7 }

pnniNodePeerGroupLeader OBJECT-TYPE

SYNTAX PnniNodeId

MAX-ACCESS read-only

STATUS current

DESCRIPTION

"The Node Identifier of the node which is currently operating as peer group leader of the peer group this node belongs to. If a PGL has not been elected, this attribute's value is set to (all) zero(s)."

::= { pnniNodePglEntry 8 }

pnniNodePglTimeStamp OBJECT-TYPE

SYNTAX TimeStamp

MAX-ACCESS read-only

STATUS current

DESCRIPTION

"The time at which the current Peer Group Leader established itself."

::= { pnniNodePglEntry 9 }

pnniNodeActiveParentNodeId OBJECT-TYPE

SYNTAX PnniNodeId

MAX-ACCESS read-only

STATUS current

DESCRIPTION

"The Node Identifier value being used by the Peer Group Leader to represent this peer group at the next higher level of the hierarchy. If this node is at the highest level of the hierarchy or if no PGL has yet been elected the PNNI Protocol Entity sets the value of this attribute to (all) zero(s)."

::= { pnniNodePglEntry 10 }

-- initial timer values table

pnniNodeTimerTable OBJECT-TYPE

SYNTAX SEQUENCE OF PnniNodeTimerEntry

MAX-ACCESS not-accessible

STATUS current

DESCRIPTION

"A table of initial PNNI timer values and significant change thresholds."

::= { pnniMIBObjects 4 }

pnniNodeTimerEntry OBJECT-TYPE

SYNTAX PnniNodeTimerEntry

MAX-ACCESS not-accessible

STATUS current

DESCRIPTION

"An entry in the table, containing initial PNNI timer values and significant change thresholds of a PNNI logical node in this switching system."

AUGMENTS { pnniNodeEntry }

::= { pnniNodeTimerTable 1 }

```

PnniNodeTimerEntry ::=
  SEQUENCE {
    pnniNodePtseHolddown          Integer32,
    pnniNodeHelloHolddown        Integer32,
    pnniNodeHelloInterval        Integer32,
    pnniNodeHelloInactivityFactor Integer32,
    pnniNodeHlinkInact           Integer32,
    pnniNodePtseRefreshInterval  Integer32,
    pnniNodePtseLifetimeFactor   INTEGER,
    pnniNodeRxmtInterval         Integer32,
    pnniNodePeerDelayedAckInterval Integer32,
    pnniNodeAvcrPm               INTEGER,
    pnniNodeAvcrMt               INTEGER,
    pnniNodeCdvPm                INTEGER,
    pnniNodeCtdPm                INTEGER,
    pnniNodeBeCRT                INTEGER,
    pnniNodeGenerateUbrAvCR      TruthValue,
    pnniNodeGenerateBeCR        TruthValue,
    pnniNodeBeCRTuningFactor     INTEGER,
    pnniNodeAccBctPm            INTEGER,
    pnniNodeMinTimeToFlush       Integer32,
    pnniNodeMaxTimeToFlush       Integer32}

pnniNodePtseHolddown OBJECT-TYPE
    SYNTAX      Integer32
    UNITS       "100 milliseconds"
    MAX-ACCESS  read-create
    STATUS      current
    DESCRIPTION
        "The initial value for the PTSE hold down timer that will be
        used by the given node to limit the rate at which it can
        re-originate PTSEs. It must be a positive non-zero number."
    REFERENCE
        "ATM Forum PNNI 1.1 Annex E MinPTSEInterval"
    DEFVAL { 10 }
    ::= { pnniNodeTimerEntry 1 }

pnniNodeHelloHolddown OBJECT-TYPE
    SYNTAX      Integer32
    UNITS       "100 milliseconds"
    MAX-ACCESS  read-create
    STATUS      current
    DESCRIPTION
        "The initial value for the Hello hold down timer that will
        be used by the given node to limit the rate at which it
        sends Hellos. It must be a positive non-zero number."
    REFERENCE
        "ATM Forum PNNI 1.1 Annex E MinHelloInterval"
    DEFVAL { 10 }
    ::= { pnniNodeTimerEntry 2 }

pnniNodeHelloInterval OBJECT-TYPE
    SYNTAX      Integer32
    UNITS       "seconds"
    MAX-ACCESS  read-create
    STATUS      current
    DESCRIPTION
        "The initial value for the Hello Timer.
        In the absence of triggered Hellos, this node will send one
        Hello packet on each of its ports on this interval."

```

REFERENCE

"ATM Forum PNNI 1.1 Annex E HelloInterval"

DEFVAL { 15 }

::= { pnniNodeTimerEntry 3 }

pnniNodeHelloInactivityFactor OBJECT-TYPE

SYNTAX Integer32

MAX-ACCESS read-create

STATUS current

DESCRIPTION

"The value for the Hello Inactivity factor that this node will use to determine when a neighbor has gone down."

REFERENCE

"ATM Forum PNNI 1.1 Annex E InactivityFactor"

DEFVAL { 5 }

::= { pnniNodeTimerEntry 4 }

pnniNodeHlinkInact OBJECT-TYPE

SYNTAX Integer32

UNITS "seconds"

MAX-ACCESS read-create

STATUS current

DESCRIPTION

"The amount of time a node will continue to advertise a horizontal (logical) link for which it has not received and processed a LGN Horizontal Link information group."

REFERENCE

"ATM Forum PNNI 1.1 Annex E HorizontalLinkInactivityTime"

DEFVAL { 120 }

::= { pnniNodeTimerEntry 5 }

pnniNodePtseRefreshInterval OBJECT-TYPE

SYNTAX Integer32

UNITS "seconds"

MAX-ACCESS read-create

STATUS current

DESCRIPTION

"The initial value for the Refresh timer that this node will use to drive (re-)origination of PTSEs in the absence of triggered updates."

REFERENCE

"ATM Forum PNNI 1.1 Annex E PTSERefreshInterval"

DEFVAL { 1800 }

::= { pnniNodeTimerEntry 6 }

pnniNodePtseLifetimeFactor OBJECT-TYPE

SYNTAX INTEGER (101..1000)

UNITS "percent"

MAX-ACCESS read-create

STATUS current

DESCRIPTION

"The value for the lifetime multiplier, expressed as a percentage. The result of multiplying the pnniNodePtseRefreshInterval attribute value by this attribute value is used as the initial lifetime that this node places into self-originated PTSEs."

REFERENCE

"ATM Forum PNNI 1.1 Annex E PTSELifetimeFactor"

DEFVAL { 200 }

::= { pnniNodeTimerEntry 7 }

pnniNodeRxmtInterval OBJECT-TYPE
 SYNTAX Integer32
 UNITS "seconds"
 MAX-ACCESS read-create
 STATUS current
 DESCRIPTION
 "The period between retransmissions of unacknowledged Database Summary packets, PTSE Request packets, and PTSPs."
 REFERENCE
 "ATM Forum PNNI 1.1 Annex E DSRxmtInterval, RequestRxmtInterval, PTSERetransmissionInterval"
 DEFVAL { 5 }
 ::= { pnniNodeTimerEntry 8 }

pnniNodePeerDelayedAckInterval OBJECT-TYPE
 SYNTAX Integer32
 UNITS "100 milliseconds"
 MAX-ACCESS read-create
 STATUS current
 DESCRIPTION
 "The minimum amount of time between transmissions of delayed PTSE acknowledgement packets."
 REFERENCE
 "ATM Forum PNNI 1.1 Annex E PeerDelayedAckInterval, Appendix G"
 DEFVAL { 10 }
 ::= { pnniNodeTimerEntry 9 }

pnniNodeAvcrPm OBJECT-TYPE
 SYNTAX INTEGER (1..99)
 UNITS "percent"
 MAX-ACCESS read-create
 STATUS current
 DESCRIPTION
 "The proportional multiplier used in the algorithms that determine significant change for AvCR parameters, expressed as a percentage."
 REFERENCE
 "ATM Forum PNNI 1.1 Section 5.8.5.2.5.4, Annex E AvCR_PM"
 DEFVAL { 50 }
 ::= { pnniNodeTimerEntry 10 }

pnniNodeAvcrMt OBJECT-TYPE
 SYNTAX INTEGER (1..99)
 UNITS "percent"
 MAX-ACCESS read-create
 STATUS current
 DESCRIPTION
 "The minimum threshold used in the algorithms that determine significant change for AvCR parameters, expressed as a percentage."
 REFERENCE
 "ATM Forum PNNI 1.1 Section 5.8.5.2.5.4, Annex E AvCR_mT"
 DEFVAL { 3 }
 ::= { pnniNodeTimerEntry 11 }

pnniNodeCdvPm OBJECT-TYPE
 SYNTAX INTEGER (1..99)
 UNITS "percent"
 MAX-ACCESS read-create

```

STATUS          current
DESCRIPTION
    "The proportional multiplier used in the algorithms that
    determine significant change for CDV metrics, expressed as
    a percentage."
REFERENCE
    "ATM Forum PNNI 1.1 Section 5.8.5.2.5.6, Annex E CDV_PM"
DEFVAL { 25 }
 ::= { pnniNodeTimerEntry 12 }

```

pnniNodeCtdPm OBJECT-TYPE

```

SYNTAX          INTEGER (1..99)
UNITS           "percent"
MAX-ACCESS     read-create
STATUS         current
DESCRIPTION
    "The proportional multiplier used in the algorithms that
    determine significant change for CTD metrics, expressed as
    a percentage."
REFERENCE
    "ATM Forum PNNI 1.1 Section 5.8.5.2.5.5, Annex E maxCTD_PM"
DEFVAL { 50 }
 ::= { pnniNodeTimerEntry 13 }

```

pnniNodeBeCRT OBJECT-TYPE

```

SYNTAX          INTEGER (1..1000)
UNITS           "percent"
MAX-ACCESS     read-create
STATUS         current
DESCRIPTION
    "The threshold used in the algorithms that determine
    significant change for BeCR parameters, expressed
    as a percentage of maxCR. This object is not applicable
    when pnniNodeGenerateBeCR is `false'."
REFERENCE
    "UBR with MDCR Addendum to UNI Signalling 4.0, PNNI 1.0 and AINI"
DEFVAL { 20 }
 ::= { pnniNodeTimerEntry 14 }

```

pnniNodeGenerateUbrAvCR OBJECT-TYPE

```

SYNTAX          TruthValue
MAX-ACCESS     read-create
STATUS         current
DESCRIPTION
    "Indicates whether the AvCR Indicator for UBR is
    set to '1' in RAIGs originated by this node."
REFERENCE
    "UBR with MDCR Addendum to UNI Signalling 4.0, PNNI 1.0 and AINI"
 ::= { pnniNodeTimerEntry 15 }

```

pnniNodeGenerateBeCR OBJECT-TYPE

```

SYNTAX          TruthValue
MAX-ACCESS     read-create
STATUS         current
DESCRIPTION
    "Indicates whether a BeCR information group is
    generated in RAIGs originated by this node. This object
    is not applicable when pnniNodeGenerateUbrAvCR is
    `false'."
REFERENCE
    "UBR with MDCR Addendum to UNI Signalling 4.0, PNNI 1.0 and AINI"

```

```
 ::= { pnniNodeTimerEntry 16 }
```

pnniNodeBeCRTuningFactor OBJECT-TYPE

```
SYNTAX      INTEGER (1..10000)
UNITS       "percent"
MAX-ACCESS  read-create
STATUS      current
DESCRIPTION
```

"The BeCR values derived by this node are multiplied by the value of this object before they are advertised in PNNI. This allows for normalization of BeCR values in multi-vendor environments where the capabilities of the switches are well known (e.g. through lab tests and interoperability tests).

This object is not applicable when pnniNodeGenerateBeCR is `false' or pnniNodeLowest is `false'."

REFERENCE

"UBR with MDCR Addendum to UNI Signalling 4.0, PNNI 1.0 and AINI"

```
DEFVAL { 100 }
```

```
 ::= { pnniNodeTimerEntry 17 }
```

pnniNodeAccBctPm OBJECT-TYPE

```
SYNTAX      INTEGER (1..99)
UNITS       "percent"
MAX-ACCESS  read-create
STATUS      current
DESCRIPTION
```

"The proportional multiplier used in the algorithms that determine significant change for AccBCT parameters, expressed as a percentage."

REFERENCE

"ATM Forum Guaranteed Frame Rate (GFR) Signalling Specification (PNNI, AINI, and UNI), Version 1.0 Section 4.2"

```
DEFVAL { 25 }
```

```
 ::= { pnniNodeTimerEntry 18 }
```

pnniNodeMinTimeToFlush OBJECT-TYPE

```
SYNTAX      Integer32
UNITS       "seconds"
MAX-ACCESS  read-create
STATUS      current
DESCRIPTION
```

"The initial amount of time to wait before the peer group leader attempts to flood the valid instance of a higher level PTSE into its peer group, after the peer group leader has proxy flushed an invalid instance of the same PTSE."

REFERENCE

"ATM Forum PNNI 1.1 section 5.10.4.1"

```
DEFVAL { 40 }
```

```
 ::= { pnniNodeTimerEntry 19 }
```

pnniNodeMaxTimeToFlush OBJECT-TYPE

```
SYNTAX      Integer32
UNITS       "seconds"
MAX-ACCESS  read-create
STATUS      current
DESCRIPTION
```

"The maximum amount of time to wait before the peer group leader attempts to flood the valid instance of a higher level PTSE into its peer group, after the peer group leader

has proxy flushed an invalid instance of the same PTSE.
This value is used when proxy flushing fails several times
for the same PTSE."

REFERENCE

"ATM Forum PNNI 1.1 section 5.10.4.1"

DEFVAL { 320 }

::= { pnniNodeTimerEntry 20 }

-- nodal SVCC-based RCC variables table

pnniNodeSvccTable OBJECT-TYPE

SYNTAX SEQUENCE OF PnniNodeSvccEntry

MAX-ACCESS not-accessible

STATUS current

DESCRIPTION

"A table of variables related to SVCC-based routing control
channels."

REFERENCE

"ATM Forum PNNI 1.1 Section 5.5"

::= { pnniMIBObjects 5 }

pnniNodeSvccEntry OBJECT-TYPE

SYNTAX PnniNodeSvccEntry

MAX-ACCESS not-accessible

STATUS current

DESCRIPTION

"An entry in the table, containing SVCC-based RCC variables
of a PNNI logical node in this switching system."

REFERENCE

"ATM Forum PNNI 1.1 Section 5.5"

AUGMENTS { pnniNodeEntry }

::= { pnniNodeSvccTable 1 }

PnniNodeSvccEntry ::=

SEQUENCE {

pnniNodeSvccInitTime Integer32,

pnniNodeSvccRetryTime Integer32,

pnniNodeSvccCallingIntegrityTime Integer32,

pnniNodeSvccCalledIntegrityTime Integer32,

pnniNodeSvccTrafficDescriptorIndex AtmTrafficDescrParamIndex

}

pnniNodeSvccInitTime OBJECT-TYPE

SYNTAX Integer32

UNITS "seconds"

MAX-ACCESS read-create

STATUS current

DESCRIPTION

"The amount of time this node will delay initiating
establishment of an SVCC to a neighbor with a numerically
lower ATM address, after determining that such an SVCC
should be established."

REFERENCE

"ATM Forum PNNI 1.1 Annex E InitialLGNSVCTimeout"

DEFVAL { 4 }

::= { pnniNodeSvccEntry 1 }

pnniNodeSvccRetryTime OBJECT-TYPE

SYNTAX Integer32

UNITS "seconds"

MAX-ACCESS read-create

```

STATUS          current
DESCRIPTION
    "The amount of time this node will delay after an apparently
    still necessary and viable SVCC-based RCC is unexpectedly
    torn down, before attempting to re-establish it."
REFERENCE
    "ATM Forum PNNI 1.1 Annex E RetryLGNSVCTimeout"
DEFVAL { 30 }
 ::= { pnniNodeSvccEntry 2 }

pnniNodeSvccCallingIntegrityTime OBJECT-TYPE
SYNTAX          Integer32
UNITS           "seconds"
MAX-ACCESS     read-create
STATUS         current
DESCRIPTION
    "The amount of time this node will wait for an SVCC, which
    it has initiated establishment of as the calling party, to
    become fully established before giving up and tearing it
    down."
REFERENCE
    "ATM Forum PNNI 1.1 Annex E SVCCallingIntegrityTime"
DEFVAL { 35 }
 ::= { pnniNodeSvccEntry 3 }

pnniNodeSvccCalledIntegrityTime OBJECT-TYPE
SYNTAX          Integer32
UNITS           "seconds"
MAX-ACCESS     read-create
STATUS         current
DESCRIPTION
    "The amount of time this node will wait for an SVCC, which
    it has decided to accept as the called party, to become
    fully established before giving up and tearing it down."
REFERENCE
    "ATM Forum PNNI 1.1 Annex E SVCCalledIntegrityTime"
DEFVAL { 50 }
 ::= { pnniNodeSvccEntry 4 }

pnniNodeSvccTrafficDescriptorIndex OBJECT-TYPE
SYNTAX          AtmTrafficDescrParamIndex
MAX-ACCESS     read-create
STATUS         current
DESCRIPTION
    "An index into the atmTrafficDescrParamTable defined in
    RFC 2515. This traffic descriptor is used when
    establishing switched virtual channels for use as
    SVCC-based RCCs to/from PNNI logical group nodes."
REFERENCE
    "ATM Forum PNNI 1.1 Section 5.5.2, Annex E
    RCCMaximumBurstSize, RCCPeakCellRate,
    RCCSustainableCellRate"
 ::= { pnniNodeSvccEntry 5 }

-- scope mapping table

pnniScopeMappingTable OBJECT-TYPE
SYNTAX          SEQUENCE OF PnniScopeMappingEntry
MAX-ACCESS     not-accessible
STATUS         current

```

DESCRIPTION

"The pnniScopeTable contains the mappings of membership and connection scope from organizational scope values (used at UNI interfaces) to PNNI scope (i.e. in terms of PNNI routing level indicators)."

REFERENCE

"ATM Forum PNNI 1.1 Section 5.3.6"

::= { pnniMIBObjects 6 }

pnniScopeMappingEntry OBJECT-TYPE

SYNTAX PnniScopeMappingEntry

MAX-ACCESS not-accessible

STATUS current

DESCRIPTION

"An entry in the table, containing scope mapping information for a PNNI logical node in this switching system."

REFERENCE

"ATM Forum PNNI 1.1 Section 5.3.6"

AUGMENTS { pnniNodeEntry }

::= { pnniScopeMappingTable 1 }

PnniScopeMappingEntry ::=

```
SEQUENCE {
    pnniScopeLocalNetwork          PnniLevel,
    pnniScopeLocalNetworkPlusOne  PnniLevel,
    pnniScopeLocalNetworkPlusTwo  PnniLevel,
    pnniScopeSiteMinusOne         PnniLevel,
    pnniScopeIntraSite            PnniLevel,
    pnniScopeSitePlusOne          PnniLevel,
    pnniScopeOrganizationMinusOne PnniLevel,
    pnniScopeIntraOrganization    PnniLevel,
    pnniScopeOrganizationPlusOne  PnniLevel,
    pnniScopeCommunityMinusOne    PnniLevel,
    pnniScopeIntraCommunity       PnniLevel,
    pnniScopeCommunityPlusOne     PnniLevel,
    pnniScopeRegional             PnniLevel,
    pnniScopeInterRegional        PnniLevel,
    pnniScopeGlobal               PnniLevel
}
```

pnniScopeLocalNetwork OBJECT-TYPE

SYNTAX PnniLevel

MAX-ACCESS read-create

STATUS current

DESCRIPTION

"The highest level of PNNI hierarchy (i.e. smallest PNNI routing level) that lies within the organizational scope value localNetwork(1)."

DEFVAL { 96 }

::= { pnniScopeMappingEntry 1 }

pnniScopeLocalNetworkPlusOne OBJECT-TYPE

SYNTAX PnniLevel

MAX-ACCESS read-create

STATUS current

DESCRIPTION

"The highest level of PNNI hierarchy (i.e. smallest PNNI routing level) that lies within the organizational scope value localNetworkPlusOne(2)."

DEFVAL { 96 }

::= { pnniScopeMappingEntry 2 }

```
pnniScopeLocalNetworkPlusTwo OBJECT-TYPE
    SYNTAX      PnniLevel
    MAX-ACCESS  read-create
    STATUS      current
    DESCRIPTION
        "The highest level of PNNI hierarchy (i.e. smallest PNNI
         routing level) that lies within the organizational scope
         value localNetworkPlusTwo(3)."
```

DEFVAL { 96 }

::= { pnniScopeMappingEntry 3 }

```
pnniScopeSiteMinusOne OBJECT-TYPE
    SYNTAX      PnniLevel
    MAX-ACCESS  read-create
    STATUS      current
    DESCRIPTION
        "The highest level of PNNI hierarchy (i.e. smallest PNNI
         routing level) that lies within the organizational scope
         value siteMinusOne(4)."
```

DEFVAL { 80 }

::= { pnniScopeMappingEntry 4 }

```
pnniScopeIntraSite OBJECT-TYPE
    SYNTAX      PnniLevel
    MAX-ACCESS  read-create
    STATUS      current
    DESCRIPTION
        "The highest level of PNNI hierarchy (i.e. smallest PNNI
         routing level) that lies within the organizational scope
         value intraSite(5)."
```

DEFVAL { 80 }

::= { pnniScopeMappingEntry 5 }

```
pnniScopeSitePlusOne OBJECT-TYPE
    SYNTAX      PnniLevel
    MAX-ACCESS  read-create
    STATUS      current
    DESCRIPTION
        "The highest level of PNNI hierarchy (i.e. smallest PNNI
         routing level) that lies within the organizational scope
         value sitePlusOne(6)."
```

DEFVAL { 72 }

::= { pnniScopeMappingEntry 6 }

```
pnniScopeOrganizationMinusOne OBJECT-TYPE
    SYNTAX      PnniLevel
    MAX-ACCESS  read-create
    STATUS      current
    DESCRIPTION
        "The highest level of PNNI hierarchy (i.e. smallest PNNI
         routing level) that lies within the organizational scope
         value organizationMinusOne(7)."
```

DEFVAL { 72 }

::= { pnniScopeMappingEntry 7 }

```
pnniScopeIntraOrganization OBJECT-TYPE
    SYNTAX      PnniLevel
    MAX-ACCESS  read-create
    STATUS      current
    DESCRIPTION
```

```

        "The highest level of PNNI hierarchy (i.e. smallest PNNI
        routing level) that lies within the organizational scope
        value intraOrganization(8)."
```

DEFVAL { 64 }

```
 ::= { pnniScopeMappingEntry 8 }
```

pnniScopeOrganizationPlusOne OBJECT-TYPE

```

SYNTAX      PnniLevel
MAX-ACCESS  read-create
STATUS      current
DESCRIPTION
    "The highest level of PNNI hierarchy (i.e. smallest PNNI
    routing level) that lies within the organizational scope
    value organizationPlusOne(9)."
```

DEFVAL { 64 }

```
 ::= { pnniScopeMappingEntry 9 }
```

pnniScopeCommunityMinusOne OBJECT-TYPE

```

SYNTAX      PnniLevel
MAX-ACCESS  read-create
STATUS      current
DESCRIPTION
    "The highest level of PNNI hierarchy (i.e. smallest PNNI
    routing level) that lies within the organizational scope
    value communityMinusOne(10)."
```

DEFVAL { 64 }

```
 ::= { pnniScopeMappingEntry 10 }
```

pnniScopeIntraCommunity OBJECT-TYPE

```

SYNTAX      PnniLevel
MAX-ACCESS  read-create
STATUS      current
DESCRIPTION
    "The highest level of PNNI hierarchy (i.e. smallest PNNI
    routing level) that lies within the organizational scope
    value intraCommunity(11)."
```

DEFVAL { 48 }

```
 ::= { pnniScopeMappingEntry 11 }
```

pnniScopeCommunityPlusOne OBJECT-TYPE

```

SYNTAX      PnniLevel
MAX-ACCESS  read-create
STATUS      current
DESCRIPTION
    "The highest level of PNNI hierarchy (i.e. smallest PNNI
    routing level) that lies within the organizational scope
    value communityPlusOne(12)."
```

DEFVAL { 48 }

```
 ::= { pnniScopeMappingEntry 12 }
```

pnniScopeRegional OBJECT-TYPE

```

SYNTAX      PnniLevel
MAX-ACCESS  read-create
STATUS      current
DESCRIPTION
    "The highest level of PNNI hierarchy (i.e. smallest PNNI
    routing level) that lies within the organizational scope
    value regional(13)."
```

DEFVAL { 32 }

```
 ::= { pnniScopeMappingEntry 13 }
```

```
pnniScopeInterRegional OBJECT-TYPE
    SYNTAX      PnniLevel
    MAX-ACCESS  read-create
    STATUS      current
    DESCRIPTION
        "The highest level of PNNI hierarchy (i.e. smallest PNNI
         routing level) that lies within the organizational scope
         value interRegional(14)."

```

```
pnniScopeGlobal OBJECT-TYPE
    SYNTAX      PnniLevel
    MAX-ACCESS  read-create
    STATUS      current
    DESCRIPTION
        "The highest level of PNNI hierarchy (i.e. smallest PNNI
         routing level) that lies within the organizational scope
         value global(15)."

```

-- Deprecated summary advertising table

```
pnniSummaryTable OBJECT-TYPE
    SYNTAX      SEQUENCE OF PnniSummaryEntry
    MAX-ACCESS  not-accessible
    STATUS      deprecated
    DESCRIPTION
        "A list of the summary address prefixes that may be
         advertised by the specified logical PNNI entity."
    REFERENCE
        "ATM Forum PNNI 1.1 Section 5.9.2"
    ::= { pnniMIBObjects 7 }
```

```
pnniSummaryEntry OBJECT-TYPE
    SYNTAX      PnniSummaryEntry
    MAX-ACCESS  not-accessible
    STATUS      deprecated
    DESCRIPTION
        "An entry in the table, containing summary address prefix
         information in this switching system."
    REFERENCE
        "ATM Forum PNNI 1.1 Section 5.9.2"
    INDEX      { pnniNodeIndex,
                 pnniSummaryAddress,
                 pnniSummaryPrefixLength }
    ::= { pnniSummaryTable 1 }
```

```
PnniSummaryEntry ::=
    SEQUENCE {
        pnniSummaryAddress          AtmAddrPrefix,
        pnniSummaryPrefixLength     PnniPrefixLength,
        pnniSummaryType             INTEGER,
        pnniSummarySuppress         TruthValue,
        pnniSummaryState            INTEGER,
        pnniSummaryRowStatus        RowStatus
    }
```

```
pnniSummaryAddress OBJECT-TYPE
```

```

SYNTAX          AtmAddrPrefix
MAX-ACCESS      not-accessible
STATUS          deprecated
DESCRIPTION
    "The ATM End System Address prefix for the summary."
 ::= { pnniSummaryEntry 1 }

pnniSummaryPrefixLength OBJECT-TYPE
SYNTAX          PnniPrefixLength
MAX-ACCESS      not-accessible
STATUS          deprecated
DESCRIPTION
    "The prefix length for the summary."
 ::= { pnniSummaryEntry 2 }

pnniSummaryType OBJECT-TYPE
SYNTAX          INTEGER { internal(1), exterior(2) }
MAX-ACCESS      read-create
STATUS          deprecated
DESCRIPTION
    "The type (e.g. internal or exterior) of summary being
    described."
DEFVAL { internal }
 ::= { pnniSummaryEntry 3 }

pnniSummarySuppress OBJECT-TYPE
SYNTAX          TruthValue
MAX-ACCESS      read-create
STATUS          deprecated
DESCRIPTION
    "Determines what is done with addresses that are being
    summarized by the instance. The default value (e.g. false)
    will indicate that the summary should propagate into the
    peer group. Network Management will be able to set the
    value of this attribute to `suppress' (e.g. true), which
    suppresses the summary and any reachable addresses it
    summarizes from being advertised into the peer group."
DEFVAL { false }
 ::= { pnniSummaryEntry 4 }

pnniSummaryState OBJECT-TYPE
SYNTAX          INTEGER {
                                advertising(1),
                                suppressing(2),
                                inactive(3)
                            }
MAX-ACCESS      read-only
STATUS          deprecated
DESCRIPTION
    "Indicates whether the summary is currently being advertised
    by the node within the local switching system into its peer
    group."
 ::= { pnniSummaryEntry 5 }

pnniSummaryRowStatus OBJECT-TYPE
SYNTAX          RowStatus
MAX-ACCESS      read-create
STATUS          deprecated
DESCRIPTION
    "To create, delete, activate and de-activate a summary."
 ::= { pnniSummaryEntry 6 }

```

```
-- Summary address table

pnniSummaryAddressTable OBJECT-TYPE
    SYNTAX          SEQUENCE OF PnniSummaryAddressEntry
    MAX-ACCESS      not-accessible
    STATUS          current
    DESCRIPTION
        "A list of the summary address prefixes that may be
         advertised by the specified logical PNNI entity."
    REFERENCE
        "ATM Forum PNNI 1.1 Section 5.9.2"
    ::= { pnniMIBObjects 20 }

pnniSummaryAddressEntry OBJECT-TYPE
    SYNTAX          PnniSummaryAddressEntry
    MAX-ACCESS      not-accessible
    STATUS          current
    DESCRIPTION
        "An entry in the table, containing summary address prefix
         information in this switching system."
    REFERENCE
        "ATM Forum PNNI 1.1 Section 5.9.2"
    INDEX           { pnniNodeIndex,
                    pnniSummaryAddressType,
                    pnniSummaryAddressAddress,
                    pnniSummaryAddressPrefixLength }
    ::= { pnniSummaryAddressTable 1 }

PnniSummaryAddressEntry ::=
    SEQUENCE {
        pnniSummaryAddressType          INTEGER,
        pnniSummaryAddressAddress       AtmAddrPrefix,
        pnniSummaryAddressPrefixLength  PnniPrefixLength,
        pnniSummaryAddressSuppress      TruthValue,
        pnniSummaryAddressState         INTEGER,
        pnniSummaryAddressRowStatus     RowStatus
    }

pnniSummaryAddressType OBJECT-TYPE
    SYNTAX          INTEGER { internal(1), exterior(2) }
    MAX-ACCESS      not-accessible
    STATUS          current
    DESCRIPTION
        "The type (e.g. internal or exterior) of summary being
         described."
    ::= { pnniSummaryAddressEntry 1 }

pnniSummaryAddressAddress OBJECT-TYPE
    SYNTAX          AtmAddrPrefix
    MAX-ACCESS      not-accessible
    STATUS          current
    DESCRIPTION
        "The ATM End System Address prefix for the summary."
    ::= { pnniSummaryAddressEntry 2 }

pnniSummaryAddressPrefixLength OBJECT-TYPE
    SYNTAX          PnniPrefixLength
    MAX-ACCESS      not-accessible
    STATUS          current
```



```
DESCRIPTION
    "The prefix length for the summary."
 ::= { pnniSummaryAddressEntry 3 }
```

```
pnniSummaryAddressSuppress OBJECT-TYPE
SYNTAX      TruthValue
MAX-ACCESS  read-create
STATUS      current
DESCRIPTION
    "Determines what is done with addresses that are being
    summarized by the instance. The default value (e.g. false)
    will indicate that the summary should propagate into the
    peer group. Network Management will be able to set the
    value of this attribute to `suppress' (e.g. true), which
    suppresses the summary and any reachable addresses it
    summarizes from being advertised into the peer group."
DEFVAL { false }
 ::= { pnniSummaryAddressEntry 4 }
```

```
pnniSummaryAddressState OBJECT-TYPE
SYNTAX      INTEGER {
                    advertising(1),
                    suppressing(2),
                    inactive(3)
                }
MAX-ACCESS  read-only
STATUS      current
DESCRIPTION
    "Indicates whether the summary is currently being advertised
    by the node within the local switching system into its peer
    group."
 ::= { pnniSummaryAddressEntry 5 }
```

```
pnniSummaryAddressRowStatus OBJECT-TYPE
SYNTAX      RowStatus
MAX-ACCESS  read-create
STATUS      current
DESCRIPTION
    "To create, delete, activate and de-activate a summary."
 ::= { pnniSummaryAddressEntry 6 }
```

-- Interface table

```
pnniIfTable OBJECT-TYPE
SYNTAX      SEQUENCE OF PnniIfEntry
MAX-ACCESS  not-accessible
STATUS      current
DESCRIPTION
    "The pnniIfTable contains the attributes necessary to
    configure a physical interface on a switching system which
    is capable of being used for PNNI routing. Interfaces may
    represent physical connection points (i.e. copper/fiber
    connection points) or VPCs which have been configured for
    PNNI's use. Each interface is attached to a specific
    lowest-level node within the switching system.

    An ifIndex is used as the instance ID to uniquely identify
    the interface on the local switching system. This index has
    the same value as the ifIndex object defined in RFC 1573
    for the same interface, since this table correlates with
```

the ifTable in RFC 1573.

One row in this table is created by the managed system for each row in the ifTable that has an ifType of atm(37) or atmLogical(80)."

```
::= { pnniMIBObjects 8 }
```

pnniIfEntry OBJECT-TYPE

```
SYNTAX      PnniIfEntry
MAX-ACCESS  not-accessible
STATUS      current
DESCRIPTION
```

"An entry in the table, containing PNNI specific interface information in this switching system."

```
INDEX       { ifIndex }
::= { pnniIfTable 1 }
```

PnniIfEntry ::=

```
SEQUENCE {
    pnniIfNodeIndex      PnniNodeIndex,
    pnniIfPortId         PnniPortId,
    pnniIfAggrToken      PnniAggrToken,
    pnniIfVPCapability   TruthValue,
    pnniIfAdmWeightCbr   Unsigned32,
    pnniIfAdmWeightRtVbr Unsigned32,
    pnniIfAdmWeightNrtVbr Unsigned32,
    pnniIfAdmWeightAbr   Unsigned32,
    pnniIfAdmWeightUbr   Unsigned32,
    pnniIfRccServiceCategory ServiceCategory,
    pnniIfRccTrafficDescrIndex AtmTrafficDescrParamIndex,
    pnniIfAdmWeightGfr    Unsigned32
}
```

pnniIfNodeIndex OBJECT-TYPE

```
SYNTAX      PnniNodeIndex (1..65535)
MAX-ACCESS  read-write
STATUS      current
DESCRIPTION
```

"Identifies the node within the switching system that the interface is directly attached to. The value zero is not a valid value."

```
DEFVAL { 1 }
::= { pnniIfEntry 1 }
```

pnniIfPortId OBJECT-TYPE

```
SYNTAX      PnniPortId
MAX-ACCESS  read-only
STATUS      current
DESCRIPTION
```

"The Port Identifier of the port as selected by the PNNI protocol entity for the given interface. This value has meaning only within the context of the node to which the port is attached. The distinguished value zero indicates that no PNNI Port Identifier has been assigned for this interface (for example, this value may be used when the interface is not running PNNI)."

```
REFERENCE
    "ATM Forum PNNI 1.1 Section 5.3.4"
::= { pnniIfEntry 2 }
```

pnniIfAggrToken OBJECT-TYPE

SYNTAX PnniAggrToken
MAX-ACCESS read-write
STATUS current
DESCRIPTION
"The configured aggregation token for this interface. The aggregation token controls what other links the link associated with this interface will be aggregated together with."
REFERENCE
"ATM Forum PNNI 1.1 Sections 5.3.5, 5.10.3.1"
DEFVAL { 0 }
 ::= { pnniIfEntry 3 }

pnniIfVPCapability OBJECT-TYPE
SYNTAX TruthValue
MAX-ACCESS read-write
STATUS current
DESCRIPTION
"Indicates whether the interface is capable of having VPCs established within it or not."

This object may only have the value `true` for physical ATM interfaces, i.e. those with an ifType of atm(37)."
REFERENCE
"ATM Forum PNNI 1.1 Section 5.14.9.1 Table 5-34"
 ::= { pnniIfEntry 4 }

pnniIfAdmWeightCbr OBJECT-TYPE
SYNTAX Unsigned32 (1..16777215)
MAX-ACCESS read-write
STATUS current
DESCRIPTION
"The administrative weight of this interface for the constant bit rate service category."
REFERENCE
"ATM Forum PNNI 1.1 Section 5.8.1.1.3.4"
DEFVAL { 5040 }
 ::= { pnniIfEntry 5 }

pnniIfAdmWeightRtVbr OBJECT-TYPE
SYNTAX Unsigned32 (1..16777215)
MAX-ACCESS read-write
STATUS current
DESCRIPTION
"The administrative weight of this interface for the real-time variable bit rate service category."
REFERENCE
"ATM Forum PNNI 1.1 Section 5.8.1.1.3.4"
DEFVAL { 5040 }
 ::= { pnniIfEntry 6 }

pnniIfAdmWeightNrtVbr OBJECT-TYPE
SYNTAX Unsigned32 (1..16777215)
MAX-ACCESS read-write
STATUS current
DESCRIPTION
"The administrative weight of this interface for the non-real-time variable bit rate service category."
REFERENCE
"ATM Forum PNNI 1.1 Section 5.8.1.1.3.4"
DEFVAL { 5040 }

```
 ::= { pnniIfEntry 7 }

pnniIfAdmWeightAbr OBJECT-TYPE
    SYNTAX      Unsigned32 (1..16777215)
    MAX-ACCESS  read-write
    STATUS      current
    DESCRIPTION
        "The administrative weight of this interface for the
        available bit rate service category."
    REFERENCE
        "ATM Forum PNNI 1.1 Section 5.8.1.1.3.4"
    DEFVAL { 5040 }
    ::= { pnniIfEntry 8 }

pnniIfAdmWeightUbr OBJECT-TYPE
    SYNTAX      Unsigned32 (1..16777215)
    MAX-ACCESS  read-write
    STATUS      current
    DESCRIPTION
        "The administrative weight of this interface for the
        unspecified bit rate service category."
    REFERENCE
        "ATM Forum PNNI 1.1 Section 5.8.1.1.3.4"
    DEFVAL { 5040 }
    ::= { pnniIfEntry 9 }

pnniIfRccServiceCategory OBJECT-TYPE
    SYNTAX      ServiceCategory
    MAX-ACCESS  read-write
    STATUS      current
    DESCRIPTION
        "The service category used for the PNNI routing control
        channel (VCI=18) on this interface."
    REFERENCE
        "ATM Forum PNNI 1.1 Sections 5.5.2, 5.5.3"
    ::= { pnniIfEntry 10 }

pnniIfRccTrafficDescrIndex OBJECT-TYPE
    SYNTAX      AtmTrafficDescrParamIndex
    MAX-ACCESS  read-write
    STATUS      current
    DESCRIPTION
        "The traffic descriptor index referring to the entry in the
        atmTrafficDescrParamTable defined in RFC 2515 that
        specifies the traffic allocation for the PNNI routing
        control channel (VCI=18) on this interface."
    REFERENCE
        "ATM Forum PNNI 1.1 Sections 5.5.2, 5.5.3, Annex E
        RCCMaximumBurstSize, RCCPeakCellRate,
        RCCSustainableCellRate"
    ::= { pnniIfEntry 11 }

pnniIfAdmWeightGfr OBJECT-TYPE
    SYNTAX      Unsigned32 (1..16777215)
    MAX-ACCESS  read-write
    STATUS      current
    DESCRIPTION
        "The administrative weight of this interface for the
        guaranteed frame rate service category."
    REFERENCE
        "ATM Forum Guaranteed Frame Rate (GFR) Signalling Specification
```

```

(PNNI, AINI, and UNI), Version 1.0 Section 4.2"
DEFVAL { 5040 }
::= { pnniIfEntry 12 }

-- link table

pnniLinkTable OBJECT-TYPE
    SYNTAX          SEQUENCE OF PnniLinkEntry
    MAX-ACCESS      not-accessible
    STATUS          current
    DESCRIPTION
        "This table contains the attributes necessary to describe
        the operation of logical links attached to the local
        switching system and the relationship with the neighbor
        nodes on the other end of the links.  Links are attached to
        a specific node within the switching system.  A
        concatenation of the Node Index of the node within the
        local switching system and the port ID are used as the
        instance ID to uniquely identify the link.  Links may
        represent horizontal links between lowest level neighboring
        peers, outside links, uplinks, or horizontal links to/from
        LGNs.

        The entire pnniLink object is read-only, reflecting the
        fact that this information is discovered dynamically by the
        PNNI protocol rather than configured."
    REFERENCE
        "ATM Forum PNNI 1.1 Section 5.6"
    ::= { pnniMIBObjects 9 }

pnniLinkEntry OBJECT-TYPE
    SYNTAX          PnniLinkEntry
    MAX-ACCESS      not-accessible
    STATUS          current
    DESCRIPTION
        "An entry in the table, containing information about a link
        attached to a PNNI logical node in this switching system."
    REFERENCE
        "ATM Forum PNNI 1.1 Section 5.6"
    INDEX          { pnniNodeIndex,
                    pnniLinkPortId }
    ::= { pnniLinkTable 1 }

PnniLinkEntry ::=
    SEQUENCE {
        pnniLinkPortId          PnniPortId,
        pnniLinkType            INTEGER,
        pnniLinkVersion         PnniVersion,
        pnniLinkHelloState     PnniHelloState,
        pnniLinkRemoteNodeId    PnniNodeId,
        pnniLinkRemotePortId   PnniPortId,
        pnniLinkDerivedAggrToken PnniAggrToken,
        pnniLinkUpnodeId        PnniNodeId,
        pnniLinkUpnodeAtmAddress PnniAtmAddr,
        pnniLinkCommonPeerGroupId PnniPeerGroupId,
        pnniLinkIfIndex         InterfaceIndex,
        pnniLinkSvccRccIndex    PnniSvccRccIndex,
        pnniLinkRcvHellos       Counter32,
        pnniLinkXmtHellos       Counter32
    }

```

pnniLinkPortId OBJECT-TYPE

SYNTAX PnniPortId
 MAX-ACCESS not-accessible
 STATUS current

DESCRIPTION

"The Port Identifier of the link as selected by the local node. This value has meaning only within the context of the node to which the port is attached."

::= { pnniLinkEntry 1 }

pnniLinkType OBJECT-TYPE

SYNTAX INTEGER {
 unknown(1),
 lowestLevelHorizontalLink(2),
 horizontalLinkToFromLgn(3),
 lowestLevelOutsideLink(4),
 uplink(5),
 outsideLinkAndUplink(6)
 }

MAX-ACCESS read-only
 STATUS current

DESCRIPTION

"Indicates the type of link being described."

::= { pnniLinkEntry 2 }

pnniLinkVersion OBJECT-TYPE

SYNTAX PnniVersion
 MAX-ACCESS read-only
 STATUS current

DESCRIPTION

"For horizontal and outside links between lowest-level nodes and for links of unknown type, this attribute indicates the version of PNNI routing protocol used to exchange information over this link. If communication with the neighbor node has not yet been established, then the Version is set to `unknown`. For uplinks (where the port ID is not also used for the underlying outside link) or links to/from LGNs, the Version is set to `unknown`."

::= { pnniLinkEntry 3 }

pnniLinkHelloState OBJECT-TYPE

SYNTAX PnniHelloState
 MAX-ACCESS read-only
 STATUS current

DESCRIPTION

"For horizontal and outside links between lowest-level nodes and for links of unknown type, this attribute indicates the state of the Hello protocol exchange over this link. For links to/from LGNs, this attribute indicates the state of the corresponding LGN Horizontal Link Hello State Machine. For uplinks (where the port ID is not also used for the underlying outside link), this attribute is set to notApplicable."

REFERENCE

"ATM Forum PNNI 1.1 Section 5.6.2.1.2"

::= { pnniLinkEntry 4 }

pnniLinkRemoteNodeId OBJECT-TYPE

SYNTAX PnniNodeId
 MAX-ACCESS read-only

```

STATUS          current
DESCRIPTION
  "Indicates the node identifier of the remote (neighboring)
  node on the other end of the link.  If the pnniLinkType is
  `outside link and uplink', this is the node identifier of
  the lowest-level neighbor node on the other end of the
  outside link.  If the remote node ID is unknown or if the
  pnniLinkType is `uplink', this attribute is set to all
  zeros."
 ::= { pnniLinkEntry 5 }

pnniLinkRemotePortId OBJECT-TYPE
SYNTAX          PnniPortId
MAX-ACCESS      read-only
STATUS          current
DESCRIPTION
  "Indicates the port identifier of the port at the remote end
  of the link as assigned by the remote node.  If the
  pnniLinkType is `outside link and uplink', this is the port
  identifier assigned by the lowest-level neighbor node to
  identify the outside link.  If the remote port ID is
  unknown or if the pnniLinkType is `uplink', this attribute
  is set to zero."
 ::= { pnniLinkEntry 6 }

pnniLinkDerivedAggrToken OBJECT-TYPE
SYNTAX          PnniAggrToken
MAX-ACCESS      read-only
STATUS          current
DESCRIPTION
  "Indicates the derived aggregation token value used on this
  link.  For horizontal links between lowest-level nodes and
  when the link type is not yet known, this attribute takes
  the value of zero."
REFERENCE
  "ATM Forum PNNI 1.1 Section 5.10.3.1"
 ::= { pnniLinkEntry 7 }

pnniLinkUpnodeId OBJECT-TYPE
SYNTAX          PnniNodeId
MAX-ACCESS      read-only
STATUS          current
DESCRIPTION
  "For outside links and uplinks, this attribute contains the
  Node Identifier of the upnode (the neighbor node's identity
  at the level of the common peer group).  When the upnode
  has not yet been identified, this attribute is set to zero.
  For horizontal links or when the link type is not yet
  known, this attribute is set to zero."
 ::= { pnniLinkEntry 8 }

pnniLinkUpnodeAtmAddress OBJECT-TYPE
SYNTAX          PnniAtmAddr
MAX-ACCESS      read-only
STATUS          current
DESCRIPTION
  "For outside links and uplinks, this attribute contains the
  ATM End System Address used to establish connections to the
  upnode.  When the upnode has not yet been identified, this
  attribute is set to zero.  For horizontal links or when the
  link type is not yet known, this attribute is set to zero."

```

```
 ::= { pnniLinkEntry 9 }
```

pnniLinkCommonPeerGroupId OBJECT-TYPE

SYNTAX PnniPeerGroupId

MAX-ACCESS read-only

STATUS current

DESCRIPTION

"For outside links and uplinks, this attribute contains the peer group identifier of the lowest level common Peer Group in the ancestry of the neighboring node and the node within the local switching system. The value of this attribute takes on a value determined by the Hello exchange of hierarchical information that occurs between the two lowest-level border nodes. When the common peer group has not yet been identified, this attribute is set to zero. For horizontal links or when the link type is not yet known, this attribute is set to all zeros."

```
 ::= { pnniLinkEntry 10 }
```

pnniLinkIfIndex OBJECT-TYPE

SYNTAX InterfaceIndex

MAX-ACCESS read-only

STATUS current

DESCRIPTION

"For horizontal and outside links between lowest-level nodes and for links of unknown type, this attribute identifies the interface to which the logical link corresponds.

For all other cases, the value of this object is zero."

```
 ::= { pnniLinkEntry 11 }
```

pnniLinkSvccRccIndex OBJECT-TYPE

SYNTAX PnniSvccRccIndex

MAX-ACCESS read-only

STATUS current

DESCRIPTION

"For horizontal links to/from LGNs, this attribute identifies the SVCC-based RCC used to exchange information with the neighboring peer logical group node. If the pnniLinkType is not 'horizontal link to/from LGN', this attribute shall take the value of zero."

```
 ::= { pnniLinkEntry 12 }
```

pnniLinkRcvHellos OBJECT-TYPE

SYNTAX Counter32

MAX-ACCESS read-only

STATUS current

DESCRIPTION

"For horizontal and outside links between lowest-level nodes and for links of unknown type, this attribute contains a count of the number of Hello Packets received over this link. If the pnniLinkType is 'horizontal link to/from LGN' or 'uplink', this attribute is set to zero."

```
 ::= { pnniLinkEntry 13 }
```

pnniLinkXmtHellos OBJECT-TYPE

SYNTAX Counter32

MAX-ACCESS read-only

STATUS current

DESCRIPTION

"For horizontal and outside links between lowest-level nodes

and for links of unknown type, this attribute contains a count of the number of Hello Packets transmitted over this link. If the pnniLinkType is 'horizontal link to/from LGN' or 'uplink', this attribute is set to zero."

```
 ::= { pnniLinkEntry 14 }
```

-- neighboring peer table

pnniNbrPeerTable OBJECT-TYPE

```
SYNTAX          SEQUENCE OF PnniNbrPeerEntry
MAX-ACCESS      not-accessible
STATUS          current
DESCRIPTION
```

"The pnniNbrPeer Object contains all the attributes necessary to describe the relationship a node in this switching system has with a neighboring node within the same peer group. A concatenation of the Node Identifier of the node within the local switching system and the neighboring peer's Node Identifier is used to form the instance ID for this object.

The entire pnniNbrPeer object is read-only, reflecting the fact that neighboring peers are discovered dynamically by the PNNI protocol rather than configured."

REFERENCE

"ATM Forum PNNI 1.1 Sections 5.7, 5.8"

```
 ::= { pnniMIBObjects 10 }
```

pnniNbrPeerEntry OBJECT-TYPE

```
SYNTAX          PnniNbrPeerEntry
MAX-ACCESS      not-accessible
STATUS          current
DESCRIPTION
```

"An entry in the table, containing information about this node's relationship with a neighboring peer node."

REFERENCE

"ATM Forum PNNI 1.1 Sections 5.7, 5.8"

```
INDEX          { pnniNodeIndex,
                 pnniNbrPeerRemoteNodeId }
 ::= { pnniNbrPeerTable 1 }
```

PnniNbrPeerEntry ::=

```
SEQUENCE {
    pnniNbrPeerRemoteNodeId      PnniNodeId,
    pnniNbrPeerState             INTEGER,
    pnniNbrPeerSvccRccIndex      PnniSvccRccIndex,
    pnniNbrPeerPortCount         Gauge32,
    pnniNbrPeerRcvDbSums         Counter32,
    pnniNbrPeerXmtDbSums         Counter32,
    pnniNbrPeerRcvPtspSps        Counter32,
    pnniNbrPeerXmtPtspSps        Counter32,
    pnniNbrPeerRcvPtseReqs       Counter32,
    pnniNbrPeerXmtPtseReqs       Counter32,
    pnniNbrPeerRcvPtseAcks       Counter32,
    pnniNbrPeerXmtPtseAcks       Counter32
}
```

pnniNbrPeerRemoteNodeId OBJECT-TYPE

```
SYNTAX          PnniNodeId
MAX-ACCESS      not-accessible
```

```

STATUS          current
DESCRIPTION
  "The Node Identifier of the neighboring peer node."
 ::= { pnniNbrPeerEntry 1 }

pnniNbrPeerState OBJECT-TYPE
SYNTAX          INTEGER {
                    npdown(1),
                    negotiating(2),
                    exchanging(3),
                    loading(4),
                    full(5)
                  }
MAX-ACCESS      read-only
STATUS          current
DESCRIPTION
  "Indicates the state of this node's Neighboring Peer State
   Machine associated with pnniNbrPeerRemoteNodeId."
REFERENCE
  "ATM Forum PNNI 1.1 Section 5.7.2"
 ::= { pnniNbrPeerEntry 2 }

pnniNbrPeerSvccRccIndex OBJECT-TYPE
SYNTAX          PnniSvccRccIndex
MAX-ACCESS      read-only
STATUS          current
DESCRIPTION
  "Identifies the SVCC-based RCC being used to communicate
   with the neighboring peer if one exists.  If both the local
   node and the neighboring peer node are lowest-level nodes,
   this attribute is set to zero."
 ::= { pnniNbrPeerEntry 3 }

pnniNbrPeerPortCount OBJECT-TYPE
SYNTAX          Gauge32
MAX-ACCESS      read-only
STATUS          current
DESCRIPTION
  "A count of the total number of ports that connect to the
   neighboring peer.  If the neighboring peer only
   communicates via an SVCC-based RCC, the value of this
   attribute is set to zero.  Otherwise it is set to the total
   number of ports to the neighboring peer in the Hello state
   2-WayInside."
 ::= { pnniNbrPeerEntry 4 }

pnniNbrPeerRcvDbSums OBJECT-TYPE
SYNTAX          Counter32
MAX-ACCESS      read-only
STATUS          current
DESCRIPTION
  "A count of the number of Database Summary Packets received
   from the neighboring peer."
 ::= { pnniNbrPeerEntry 5 }

pnniNbrPeerXmtDbSums OBJECT-TYPE
SYNTAX          Counter32
MAX-ACCESS      read-only
STATUS          current
DESCRIPTION
  "A count of the number of Database Summary Packets

```

```

    transmitted to the neighboring peer."
 ::= { pnniNbrPeerEntry 6 }

```

```

pnniNbrPeerRcvPtsps OBJECT-TYPE
    SYNTAX      Counter32
    MAX-ACCESS  read-only
    STATUS      current
    DESCRIPTION
        "A count of the number of PTSPs received from the
        neighboring peer."
 ::= { pnniNbrPeerEntry 7 }

```

```

pnniNbrPeerXmtPtsps OBJECT-TYPE
    SYNTAX      Counter32
    MAX-ACCESS  read-only
    STATUS      current
    DESCRIPTION
        "A count of the number of PTSPs (re)transmitted to the
        neighboring peer."
 ::= { pnniNbrPeerEntry 8 }

```

```

pnniNbrPeerRcvPtseReqs OBJECT-TYPE
    SYNTAX      Counter32
    MAX-ACCESS  read-only
    STATUS      current
    DESCRIPTION
        "A count of the number of PTSE Request packets received from
        the neighboring peer."
 ::= { pnniNbrPeerEntry 9 }

```

```

pnniNbrPeerXmtPtseReqs OBJECT-TYPE
    SYNTAX      Counter32
    MAX-ACCESS  read-only
    STATUS      current
    DESCRIPTION
        "A count of the number of PTSE Request packets transmitted
        to the neighboring peer."
 ::= { pnniNbrPeerEntry 10 }

```

```

pnniNbrPeerRcvPtseAcks OBJECT-TYPE
    SYNTAX      Counter32
    MAX-ACCESS  read-only
    STATUS      current
    DESCRIPTION
        "A count of the number of PTSE Ack packets received from the
        neighboring peer."
 ::= { pnniNbrPeerEntry 11 }

```

```

pnniNbrPeerXmtPtseAcks OBJECT-TYPE
    SYNTAX      Counter32
    MAX-ACCESS  read-only
    STATUS      current
    DESCRIPTION
        "A count of the number of PTSE Ack packets transmitted to
        the neighboring peer."
 ::= { pnniNbrPeerEntry 12 }

```

```
-- neighboring peer port table
```

```
pnniNbrPeerPortTable OBJECT-TYPE
```

```

SYNTAX          SEQUENCE OF PnniNbrPeerPortEntry
MAX-ACCESS      not-accessible
STATUS          current
DESCRIPTION     "A table of all ports in Hello state 2-Way Inside to a given
                neighboring peer node. A concatenation of the Node Index
                of the node within the local switching system, the
                neighbor's Node Identifier and the Interface Index of the
                port being described forms the instance ID for this object.
                This object is only used for lowest-level nodes."
REFERENCE      "ATM Forum PNNI 1.1 Section 5.7.1 Port ID List"
 ::= { pnniMIBObjects 11 }

```

```

pnniNbrPeerPortEntry OBJECT-TYPE
SYNTAX          PnniNbrPeerPortEntry
MAX-ACCESS      not-accessible
STATUS          current
DESCRIPTION     "An entry in the table, containing information about a port
                in the Hello state 2-Way Inside from a PNNI logical node in
                this switching system to a neighboring peer node."
INDEX           { pnniNodeIndex,
                  pnniNbrPeerRemoteNodeId,
                  pnniNbrPeerPortId
                }
 ::= { pnniNbrPeerPortTable 1 }

```

```

PnniNbrPeerPortEntry ::=
SEQUENCE {
    pnniNbrPeerPortId          PnniPortId,
    pnniNbrPeerPortFloodStatus TruthValue
}

```

```

pnniNbrPeerPortId OBJECT-TYPE
SYNTAX          PnniPortId
MAX-ACCESS      not-accessible
STATUS          current
DESCRIPTION     "The port ID of a port to the neighboring peer that is in
                the Hello state 2-Way Inside."
 ::= { pnniNbrPeerPortEntry 1 }

```

```

pnniNbrPeerPortFloodStatus OBJECT-TYPE
SYNTAX          TruthValue
MAX-ACCESS      read-only
STATUS          current
DESCRIPTION     "Indicates whether the port is being used for transmission
                of flooding and database synchronization information to the
                neighboring peer."
 ::= { pnniNbrPeerPortEntry 2 }

```

-- pnni SVCC-based routing control channel table

```

pnniSvccRccTable OBJECT-TYPE
SYNTAX          SEQUENCE OF PnniSvccRccEntry
MAX-ACCESS      not-accessible
STATUS          current
DESCRIPTION

```

"A table containing the attributes necessary to analyze the operation of the PNNI protocol on SVCC-based Routing Control Channels. This entire object is read-only, reflecting the fact that SVCC-based RCCs are established dynamically during operation of the PNNI protocol rather than configured."

REFERENCE

"ATM Forum PNNI 1.1 Sections 5.5.6, 5.6.3.1"

::= { pnniMIBObjects 12 }

pnniSvccRccEntry OBJECT-TYPE

SYNTAX PnniSvccRccEntry
MAX-ACCESS not-accessible
STATUS current

DESCRIPTION

"An entry in the table, containing information about an SVCC-based RCC from a PNNI logical node in this switching system."

REFERENCE

"ATM Forum PNNI 1.1 Sections 5.5.6, 5.6.3.1"

INDEX { pnniNodeIndex,
pnniSvccRccIndex }
::= { pnniSvccRccTable 1 }

PnniSvccRccEntry ::=

SEQUENCE {
pnniSvccRccIndex PnniSvccRccIndex,
pnniSvccRccVersion PnniVersion,
pnniSvccRccHelloState PnniHelloState,
pnniSvccRccRemoteNodeId PnniNodeId,
pnniSvccRccRemoteAtmAddress PnniAtmAddr,
pnniSvccRccRcvHellos Counter32,
pnniSvccRccXmtHellos Counter32,
pnniSvccRccIfIndex InterfaceIndex,
pnniSvccRccVpi INTEGER,
pnniSvccRccVci INTEGER
}

pnniSvccRccIndex OBJECT-TYPE

SYNTAX PnniSvccRccIndex
MAX-ACCESS not-accessible
STATUS current

DESCRIPTION

"An index into the node's tables of SVCC-based RCCs."

::= { pnniSvccRccEntry 1 }

pnniSvccRccVersion OBJECT-TYPE

SYNTAX PnniVersion
MAX-ACCESS read-only
STATUS current

DESCRIPTION

"The version of the PNNI routing protocol used to exchange information with the neighbor node."

::= { pnniSvccRccEntry 2 }

pnniSvccRccHelloState OBJECT-TYPE

SYNTAX PnniHelloState
MAX-ACCESS read-only
STATUS current

DESCRIPTION

"The state of the Hello protocol exchange over the

SVCC-based RCC.

Note: the Down state indicates that the SVCC establishment is in progress."

```
::= { pnniSvccRccEntry 3 }
```

pnniSvccRccRemoteNodeId OBJECT-TYPE

SYNTAX PnniNodeId

MAX-ACCESS read-only

STATUS current

DESCRIPTION

"The remote node at which the SVCC-based RCC terminates."

```
::= { pnniSvccRccEntry 4 }
```

pnniSvccRccRemoteAtmAddress OBJECT-TYPE

SYNTAX PnniAtmAddr

MAX-ACCESS read-only

STATUS current

DESCRIPTION

"The ATM End System Address to which SVCC establishment is attempted."

```
::= { pnniSvccRccEntry 5 }
```

pnniSvccRccRcvHellos OBJECT-TYPE

SYNTAX Counter32

MAX-ACCESS read-only

STATUS current

DESCRIPTION

"A count of the number of Hello Packets received over this SVCC-based RCC."

```
::= { pnniSvccRccEntry 6 }
```

pnniSvccRccXmtHellos OBJECT-TYPE

SYNTAX Counter32

MAX-ACCESS read-only

STATUS current

DESCRIPTION

"A count of the number of Hello Packets transmitted over this SVCC-based RCC."

```
::= { pnniSvccRccEntry 7 }
```

pnniSvccRccIfIndex OBJECT-TYPE

SYNTAX InterfaceIndex

MAX-ACCESS read-only

STATUS current

DESCRIPTION

"The interface from which the SVCC-based RCC leaves the switching system. If the SVCC-based RCC has not yet been established, then this attribute takes the value of zero."

```
::= { pnniSvccRccEntry 8 }
```

pnniSvccRccVpi OBJECT-TYPE

SYNTAX INTEGER (0..4095)

MAX-ACCESS read-only

STATUS current

DESCRIPTION

"The VPI used at the interface from which the SVCC-based RCC leaves the switching system. If the SVCC-based RCC has not yet been established, then this attribute takes the value of zero "

```
::= { pnniSvccRccEntry 9 }
```

```
pnniSvccRccVci OBJECT-TYPE
    SYNTAX          INTEGER (0..65535)
    MAX-ACCESS      read-only
    STATUS          current
    DESCRIPTION
        "The VCI used at the interface from which the SVCC-based RCC
         leaves the switching system.  If the SVCC-based RCC has not
         yet been established, then this attribute takes the value
         of zero "
    ::= { pnniSvccRccEntry 10 }
```

```
-- PTSE table
```

```
pnniPtseTable OBJECT-TYPE
    SYNTAX          SEQUENCE OF PnniPtseEntry
    MAX-ACCESS      not-accessible
    STATUS          current
    DESCRIPTION
        "The pnniPtse object contains the attributes that describe
         the most recent instances of PTSEs in a node's topology
         database.  A concatenation of the Node Identifier of the
         local node that received the PTSE, the originating Node's
         Node Identifier and the PTSE Identifier are used to form
         the instance ID for an instance of this object."
    REFERENCE
        "ATM Forum PNNI 1.1 Section 5.8.2"
    ::= { pnniMIBObjects 13 }
```

```
pnniPtseEntry OBJECT-TYPE
    SYNTAX          PnniPtseEntry
    MAX-ACCESS      not-accessible
    STATUS          current
    DESCRIPTION
        "An entry in the table, containing information about a PTSE
         in the topology database of a PNNI logical node in this
         switching system."
    REFERENCE
        "ATM Forum PNNI 1.1 Section 5.8.2"
    INDEX          { pnniNodeIndex,
                    pnniPtseOriginatingNodeId,
                    pnniPtseId }
    ::= { pnniPtseTable 1 }
```

```
PnniPtseEntry ::=
    SEQUENCE {
        pnniPtseOriginatingNodeId    PnniNodeId,
        pnniPtseId                   Unsigned32,
        pnniPtseType                  INTEGER,
        pnniPtseSequenceNum          Unsigned32,
        pnniPtseChecksum              Unsigned32,
        pnniPtseLifeTime             Unsigned32,
        pnniPtseInfo                  OCTET STRING
    }
```

```
pnniPtseOriginatingNodeId OBJECT-TYPE
    SYNTAX          PnniNodeId
    MAX-ACCESS      not-accessible
    STATUS          current
    DESCRIPTION
```

"The Node Identifier of the node that originated the PTSE."
 ::= { pnniPtseEntry 1 }

pnniPtseId OBJECT-TYPE

SYNTAX Unsigned32
 MAX-ACCESS not-accessible
 STATUS current
 DESCRIPTION

"The value of the PTSE Identifier assigned to the PTSE by its originator."

::= { pnniPtseEntry 2 }

pnniPtseType OBJECT-TYPE

SYNTAX INTEGER {
 other(1),
 nodalStateParameters(96),
 nodalInformation(97),
 internalReachableAddresses(224),
 exteriorReachableAddresses(256),
 horizontalLinks(288),
 uplinks(289)
 }

MAX-ACCESS read-only
 STATUS current
 DESCRIPTION

"The type of information contained in the PTSE."

::= { pnniPtseEntry 3 }

pnniPtseSequenceNum OBJECT-TYPE

SYNTAX Unsigned32
 MAX-ACCESS read-only
 STATUS current
 DESCRIPTION

"The sequence number of the instance of the PTSE as it appears in the local topology database."

::= { pnniPtseEntry 4 }

pnniPtseChecksum OBJECT-TYPE

SYNTAX Unsigned32 (0..65535)
 MAX-ACCESS read-only
 STATUS current
 DESCRIPTION

"The value of the PTSE checksum as it appears in the local topology database."

::= { pnniPtseEntry 5 }

pnniPtseLifeTime OBJECT-TYPE

SYNTAX Unsigned32 (0..65535)
 UNITS "seconds"
 MAX-ACCESS read-only
 STATUS current
 DESCRIPTION

"The value of the remaining lifetime for the given PTSE as it appears in the local topology database."

::= { pnniPtseEntry 6 }

pnniPtseInfo OBJECT-TYPE

SYNTAX OCTET STRING (SIZE(0..65535))
 MAX-ACCESS read-only
 STATUS current
 DESCRIPTION

"An unformatted hexadecimal dump of the PTSE contents in full.

Note: If the size of the PTSE contents is larger than the maximum size of SNMP packets then this is truncated."
 ::= { pnniPtseEntry 7 }

-- pnni map table

pnniMapTable OBJECT-TYPE

SYNTAX SEQUENCE OF PnniMapEntry
 MAX-ACCESS not-accessible
 STATUS current
 DESCRIPTION

"A table containing attributes necessary to find and analyze the operation of all links and nodes within the PNNI hierarchy, as seen from the perspective of a local node. An instance of a pnniMap Object describes a link in terms of a node at one end of the link. Normally there will be two instances of the pnniMap object in the MIB for each horizontal link. The two instances provide information for Network management to map port identifiers from the nodes at both ends to the link between them. A concatenation of the Local Node Index, Originating Node Identifier and Originating Port Identifier are used to form the instance ID for this object.

This entire object is read-only, reflecting the fact that the map is discovered dynamically during operation of the PNNI protocol rather than configured."

::= { pnniMIBObjects 14 }

pnniMapEntry OBJECT-TYPE

SYNTAX PnniMapEntry
 MAX-ACCESS not-accessible
 STATUS current
 DESCRIPTION

"An entry in the table, containing connectivity information about a node or link in the PNNI routing domain, as seen from the perspective of a PNNI logical node in this switching system."

INDEX { pnniNodeIndex,
 pnniMapOriginatingNodeId,
 pnniMapOriginatingPortId,
 pnniMapIndex }

::= { pnniMapTable 1 }

PnniMapEntry ::=

SEQUENCE {
 pnniMapOriginatingNodeId PnniNodeId,
 pnniMapOriginatingPortId PnniPortId,
 pnniMapIndex INTEGER,
 pnniMapType INTEGER,
 pnniMapPeerGroupId PnniPeerGroupId,
 pnniMapAggrToken PnniAggrToken,
 pnniMapRemoteNodeId PnniNodeId,
 pnniMapRemotePortId PnniPortId,
 pnniMapVPCapability TruthValue,
 pnniMapPtseId Unsigned32,
 pnniMapMetricsTag PnniMetricsTag

}

pnniMapOriginatingNodeId OBJECT-TYPE

SYNTAX PnniNodeId
 MAX-ACCESS not-accessible
 STATUS current
 DESCRIPTION

"The node identifier of the node whose connectivity within itself or to other nodes is being described."

::= { pnniMapEntry 1 }

pnniMapOriginatingPortId OBJECT-TYPE

SYNTAX PnniPortId
 MAX-ACCESS not-accessible
 STATUS current
 DESCRIPTION

"The port identifier of the port as assigned by the originating node, to which the port is attached."

::= { pnniMapEntry 2 }

pnniMapIndex OBJECT-TYPE

SYNTAX INTEGER (0..65535)
 MAX-ACCESS not-accessible
 STATUS current
 DESCRIPTION

"An index into the set of link and nodal connectivity associated with the originating node and port. This index is needed since there may be multiple entries for nodal connectivity from a specific node and port pair, in addition to any entry for a horizontal link or uplink."

::= { pnniMapEntry 3 }

pnniMapType OBJECT-TYPE

SYNTAX INTEGER {
 horizontalLink(1),
 uplink(2),
 node(3)
 }

MAX-ACCESS read-only
 STATUS current
 DESCRIPTION

"The type of PNNI entity being described by this entry in the table."

::= { pnniMapEntry 4 }

pnniMapPeerGroupId OBJECT-TYPE

SYNTAX PnniPeerGroupId
 MAX-ACCESS read-only
 STATUS current
 DESCRIPTION

"Identifies the peer group of the originating node."

::= { pnniMapEntry 5 }

pnniMapAggrToken OBJECT-TYPE

SYNTAX PnniAggrToken
 MAX-ACCESS read-only
 STATUS current
 DESCRIPTION

"For horizontal links to/from LGNs and for uplinks, this attribute contains the derived aggregation token value for this link. For nodes and for horizontal links between

lowest-level nodes, this attribute is set to zero."
 ::= { pnniMapEntry 6 }

pnniMapRemoteNodeId OBJECT-TYPE
 SYNTAX PnniNodeId
 MAX-ACCESS read-only
 STATUS current
 DESCRIPTION
 "For horizontal links and uplinks, this attribute contains the node identifier of the node at the other end of the link from the originating node. If unknown, the PNNI protocol entity sets this attribute's value to (all) zero(s). For nodes, this attribute's value is set to (all) zero(s)."
 ::= { pnniMapEntry 7 }

pnniMapRemotePortId OBJECT-TYPE
 SYNTAX PnniPortId
 MAX-ACCESS read-only
 STATUS current
 DESCRIPTION
 "For horizontal links and uplinks, this attribute contains the port identifier of the port at the remote end of the link as assigned by the remote node. If unknown, the PNNI protocol entity sets this attribute's value to zero.

 For nodes, this attribute contains the port identifier of the port at the other end of the spoke or bypass from the originating port. When the originating port ID is zero, a value of zero indicates the default radius. When the originating port ID is non-zero, a value of zero indicates the nodal nucleus."
 ::= { pnniMapEntry 8 }

pnniMapVPCapability OBJECT-TYPE
 SYNTAX TruthValue
 MAX-ACCESS read-only
 STATUS current
 DESCRIPTION
 "Indicates whether VPCs can be established across the PNNI entity being described by this entry in the pnniMapTable."
 ::= { pnniMapEntry 9 }

pnniMapPtseId OBJECT-TYPE
 SYNTAX Unsigned32
 MAX-ACCESS read-only
 STATUS current
 DESCRIPTION
 "The value of the PTSE Identifier for the PTSE being originated by the originating node which contains the information group(s) describing the PNNI entity."
 ::= { pnniMapEntry 10 }

pnniMapMetricsTag OBJECT-TYPE
 SYNTAX PnniMetricsTag
 MAX-ACCESS read-only
 STATUS current
 DESCRIPTION
 "An arbitrary integer that is used to associate a set of traffic parameters that are always advertised together."

```

Within this set, the parameters are distinguished by the
service categories and direction to which a set of
parameters apply. This value is used as an index into
the pnniMetricsTable. The distinguished value zero
indicates that no metrics are associated with the link or
nodal connectivity."
 ::= { pnniMapEntry 11 }

-- nodal map table

pnniMapNodeTable OBJECT-TYPE
    SYNTAX          SEQUENCE OF PnniMapNodeEntry
    MAX-ACCESS      not-accessible
    STATUS          current
    DESCRIPTION
        "A list of nodes as seen from the perspective of a local
        node. The pnniMapNodeTable contains all information
        learned by the local node from nodal information PTSEs.
        This entire object is read-only, reflecting the fact that
        the map is discovered dynamically during operation of the
        PNNI protocol rather than configured."
    ::= { pnniMIBObjects 15 }

pnniMapNodeEntry OBJECT-TYPE
    SYNTAX          PnniMapNodeEntry
    MAX-ACCESS      not-accessible
    STATUS          current
    DESCRIPTION
        "An entry in the table, containing information about a node
        in the PNNI routing domain, as seen from the perspective of
        a logical node in this switching system."
    INDEX           { pnniNodeIndex,
                    pnniMapNodeId }
    ::= { pnniMapNodeTable 1 }

PnniMapNodeEntry ::=
    SEQUENCE {
        pnniMapNodeId          PnniNodeId,
        pnniMapNodePeerGroupId PnniPeerGroupId,
        pnniMapNodeAtmAddress  PnniAtmAddr,
        pnniMapNodeRestrictedTransit TruthValue,
        pnniMapNodeComplexRep  TruthValue,
        pnniMapNodeRestrictedBranching TruthValue,
        pnniMapNodeDatabaseOverload TruthValue,
        pnniMapNodeIAMLeader   TruthValue,
        pnniMapNodeLeadershipPriority INTEGER,
        pnniMapNodePreferredPgl PnniNodeId,
        pnniMapNodeParentNodeId PnniNodeId,
        pnniMapNodeParentAtmAddress PnniAtmAddr,
        pnniMapNodeParentPeerGroupId PnniPeerGroupId,
        pnniMapNodeParentPglNodeId PnniNodeId
    }

pnniMapNodeId OBJECT-TYPE
    SYNTAX          PnniNodeId
    MAX-ACCESS      not-accessible
    STATUS          current
    DESCRIPTION
        "Identifies the node whose nodal information is being
        described."

```

```

 ::= { pnniMapNodeEntry 1 }

pnniMapNodePeerGroupId OBJECT-TYPE
    SYNTAX      PnniPeerGroupId
    MAX-ACCESS  read-only
    STATUS      current
    DESCRIPTION
        "Identifies the peer group of the originating node."
 ::= { pnniMapNodeEntry 2 }

pnniMapNodeAtmAddress OBJECT-TYPE
    SYNTAX      PnniAtmAddr
    MAX-ACCESS  read-only
    STATUS      current
    DESCRIPTION
        "The ATM End System Address of the originating node."
 ::= { pnniMapNodeEntry 3 }

pnniMapNodeRestrictedTransit OBJECT-TYPE
    SYNTAX      TruthValue
    MAX-ACCESS  read-only
    STATUS      current
    DESCRIPTION
        "Indicates whether the originating node is restricted to
        only allow support of SVCs originating or terminating at
        this node. A value of `true' indicates that the transit
        capabilities are restricted, i.e., transit connections are
        not allowed, whereas a value of `false' indicates that
        transit connections are allowed. This attribute reflects
        the setting of the restricted transit bit received in the
        nodal information PTSE of the originating node."
 ::= { pnniMapNodeEntry 4 }

pnniMapNodeComplexRep OBJECT-TYPE
    SYNTAX      TruthValue
    MAX-ACCESS  read-only
    STATUS      current
    DESCRIPTION
        "Indicates whether the originating node uses the complex
        node representation. If the value is `true', the spokes
        and bypasses that make up the complex node representation
        should be found in the pnniMapTable. This attribute
        reflects the setting of the nodal representation bit
        received in the nodal information PTSE of the originating
        node."
 ::= { pnniMapNodeEntry 5 }

pnniMapNodeRestrictedBranching OBJECT-TYPE
    SYNTAX      TruthValue
    MAX-ACCESS  read-only
    STATUS      current
    DESCRIPTION
        "Indicates whether the originating node is able to support
        additional branches. If the value is `false', then it can
        support additional branches. This attribute reflects the
        setting of the restricted branching bit received in the
        nodal information PTSE of the originating node."
 ::= { pnniMapNodeEntry 6 }

pnniMapNodeDatabaseOverload OBJECT-TYPE
    SYNTAX      TruthValue

```

```

MAX-ACCESS      read-only
STATUS          current
DESCRIPTION
    "Indicates whether the originating node is currently
    operating in topology database overload state.  This
    attribute has the same value as the Non-transit for PGL
    Election bit in the nodal information group originated by
    this node."
 ::= { pnniMapNodeEntry 7 }

```

```

pnniMapNodeIAmLeader OBJECT-TYPE
SYNTAX          TruthValue
MAX-ACCESS      read-only
STATUS          current
DESCRIPTION
    "Indicates whether the originating node claims to be peer
    group leader of its peer group.  This attribute reflects
    the setting of the 'I am Leader' bit received in the nodal
    information PTSE of the originating node."
 ::= { pnniMapNodeEntry 8 }

```

```

pnniMapNodeLeadershipPriority OBJECT-TYPE
SYNTAX          INTEGER (0..255)
MAX-ACCESS      read-only
STATUS          current
DESCRIPTION
    "The Leadership priority value advertised by the originating
    node."
 ::= { pnniMapNodeEntry 9 }

```

```

pnniMapNodePreferredPgl OBJECT-TYPE
SYNTAX          PnniNodeId
MAX-ACCESS      read-only
STATUS          current
DESCRIPTION
    "Identifies the node which the originating node believes
    should be or is peer group leader of its peer group.  If
    the originating node has not chosen a Preferred PGL, this
    attribute's value is set to (all) zero(s)."
 ::= { pnniMapNodeEntry 10 }

```

```

pnniMapNodeParentNodeId OBJECT-TYPE
SYNTAX          PnniNodeId
MAX-ACCESS      read-only
STATUS          current
DESCRIPTION
    "When the originating node is a peer group leader, indicates
    the node ID of the parent LGN.  If the originating node is
    not peer group leader of its peer group, this attribute's
    value is set to (all) zero(s)."
 ::= { pnniMapNodeEntry 11 }

```

```

pnniMapNodeParentAtmAddress OBJECT-TYPE
SYNTAX          PnniAtmAddr
MAX-ACCESS      read-only
STATUS          current
DESCRIPTION
    "When the originating node is a peer group leader, indicates
    the ATM address of the parent LGN.  If the originating node
    is not peer group leader of its peer group, this
    attribute's value is set to (all) zero(s)."

```

```

 ::= { pnniMapNodeEntry 12 }

pnniMapNodeParentPeerGroupId OBJECT-TYPE
    SYNTAX      PnniPeerGroupId
    MAX-ACCESS  read-only
    STATUS      current
    DESCRIPTION
        "When the originating node is a peer group leader, indicates
         the node's parent peer group ID.  If the originating node
         is not peer group leader of its peer group, this
         attribute's value is set to (all) zero(s)."
 ::= { pnniMapNodeEntry 13 }

pnniMapNodeParentPglNodeId OBJECT-TYPE
    SYNTAX      PnniNodeId
    MAX-ACCESS  read-only
    STATUS      current
    DESCRIPTION
        "When the originating node is a peer group leader,
         identifies the node elected as peer group leader of the
         parent peer group.  If the originating node is not peer
         group leader of its peer group, this attribute's value is
         set to (all) zero(s)."
 ::= { pnniMapNodeEntry 14 }

-- address map table

pnniMapAddrTable OBJECT-TYPE
    SYNTAX      SEQUENCE OF PnniMapAddrEntry
    MAX-ACCESS  not-accessible
    STATUS      current
    DESCRIPTION
        "The pnniMapAddr MIB Object contains a list of all reachable
         addresses from each node visible to the local node.  The
         Local Node Index, Advertising Node ID, Advertised Port ID,
         Reachable Address, and Address prefix length are combined
         to form an instance ID for this object.  The entire object
         is read-only, reflecting the fact that reachable addresses
         are discovered during dynamic operation of the PNNI
         protocol rather than configured."
 ::= { pnniMIBObjects 16 }

pnniMapAddrEntry OBJECT-TYPE
    SYNTAX      PnniMapAddrEntry
    MAX-ACCESS  not-accessible
    STATUS      current
    DESCRIPTION
        "An entry in the table, containing information about an
         address prefix reachable from a node in the PNNI routing
         domain, as seen from the perspective of a PNNI logical node
         in this switching system."
    INDEX      { pnniNodeIndex,
                 pnniMapAddrAdvertisingNodeId,
                 pnniMapAddrAdvertisedPortId,
                 pnniMapAddrIndex }
 ::= { pnniMapAddrTable 1 }

PnniMapAddrEntry ::=
    SEQUENCE {
        pnniMapAddrAdvertisingNodeId  PnniNodeId,

```

```

pnniMapAddrAdvertisedPortId    PnniPortId,
pnniMapAddrIndex               INTEGER,
pnniMapAddrAddress             AtmAddrPrefix,
pnniMapAddrPrefixLength        PnniPrefixLength
}

```

pnniMapAddrAdvertisingNodeId OBJECT-TYPE

```

SYNTAX          PnniNodeId
MAX-ACCESS      not-accessible
STATUS          current
DESCRIPTION
    "The node ID of a node advertising reachability to the
    address prefix."
 ::= { pnniMapAddrEntry 1 }

```

pnniMapAddrAdvertisedPortId OBJECT-TYPE

```

SYNTAX          PnniPortId
MAX-ACCESS      not-accessible
STATUS          current
DESCRIPTION
    "The port identifier used from the advertising node to reach
    the given address prefix."
 ::= { pnniMapAddrEntry 2 }

```

pnniMapAddrIndex OBJECT-TYPE

```

SYNTAX          INTEGER (1..2147483647)
MAX-ACCESS      not-accessible
STATUS          current
DESCRIPTION
    "An arbitrary index that is used to enumerate all of the
    addresses advertised by the specified node."
 ::= { pnniMapAddrEntry 3 }

```

pnniMapAddrAddress OBJECT-TYPE

```

SYNTAX          AtmAddrPrefix
MAX-ACCESS      read-only
STATUS          current
DESCRIPTION
    "The value of the ATM End System Address prefix."
 ::= { pnniMapAddrEntry 4 }

```

pnniMapAddrPrefixLength OBJECT-TYPE

```

SYNTAX          PnniPrefixLength
MAX-ACCESS      read-only
STATUS          current
DESCRIPTION
    "The Prefix length to be applied to the ATM End System
    Address prefix."
 ::= { pnniMapAddrEntry 5 }

```

-- TNS map table

pnniMapTnsTable OBJECT-TYPE

```

SYNTAX          SEQUENCE OF PnniMapTnsEntry
MAX-ACCESS      not-accessible
STATUS          current
DESCRIPTION
    "A list of all reachable transit networks from each node
    visible to the local node. The Local Node Index,
    Advertising Node ID, Advertised Port ID, Transit Network

```



```

Type, Transit Network Plan, and Transit Network ID are
combined to form an instance ID for this object. The entire
object is read-only, reflecting the fact that reachable
transit networks are discovered during dynamic operation of
the PNNI protocol rather than configured."
 ::= { pnniMIBObjects 17 }

pnniMapTnsEntry OBJECT-TYPE
    SYNTAX      PnniMapTnsEntry
    MAX-ACCESS  not-accessible
    STATUS      current
    DESCRIPTION
        "An entry in the table, containing information about a
        transit network reachable from a node in the PNNI routing
        domain, as seen from the perspective of a PNNI logical node
        in this switching system."
    INDEX       { pnniNodeIndex,
                  pnniMapTnsAdvertisingNodeId,
                  pnniMapTnsAdvertisedPortId,
                  pnniMapTnsType,
                  pnniMapTnsPlan,
                  pnniMapTnsId }
    ::= { pnniMapTnsTable 1 }

PnniMapTnsEntry ::=
    SEQUENCE {
        pnniMapTnsAdvertisingNodeId  PnniNodeId,
        pnniMapTnsAdvertisedPortId  PnniPortId,
        pnniMapTnsType               TnsType,
        pnniMapTnsPlan               TnsPlan,
        pnniMapTnsId                 DisplayString
    }

pnniMapTnsAdvertisingNodeId OBJECT-TYPE
    SYNTAX      PnniNodeId
    MAX-ACCESS  not-accessible
    STATUS      current
    DESCRIPTION
        "The node ID of a node advertising reachability to the
        transit network."
    ::= { pnniMapTnsEntry 1 }

pnniMapTnsAdvertisedPortId OBJECT-TYPE
    SYNTAX      PnniPortId
    MAX-ACCESS  not-accessible
    STATUS      current
    DESCRIPTION
        "The port identifier used from the advertising node to reach
        the given transit network."
    ::= { pnniMapTnsEntry 2 }

pnniMapTnsType OBJECT-TYPE
    SYNTAX      TnsType
    MAX-ACCESS  not-accessible
    STATUS      current
    DESCRIPTION
        "The type of network identification used for this transit
        network."
    ::= { pnniMapTnsEntry 3 }

pnniMapTnsPlan OBJECT-TYPE

```

```

SYNTAX          TnsPlan
MAX-ACCESS      not-accessible
STATUS          current
DESCRIPTION     "The network identification plan according to which network
                identification has been assigned."
 ::= { pnniMapTnsEntry 4 }

pnniMapTnsId OBJECT-TYPE
SYNTAX          DisplayString
MAX-ACCESS      read-only
STATUS          current
DESCRIPTION     "The value of the transit network identifier."
 ::= { pnniMapTnsEntry 5 }

-- pnni metrics table

pnniMetricsTable OBJECT-TYPE
SYNTAX          SEQUENCE OF PnniMetricsEntry
MAX-ACCESS      not-accessible
STATUS          current
DESCRIPTION     "This entity's table of PNNI parameters either associated
                with a PNNI entity or for the connectivity between a PNNI
                node and a reachable address or transit network."
REFERENCE      "ATM Forum PNNI 1.1 Section 5.8.1.1.3"
 ::= { pnniMIBObjects 18 }

pnniMetricsEntry OBJECT-TYPE
SYNTAX          PnniMetricsEntry
MAX-ACCESS      not-accessible
STATUS          current
DESCRIPTION     "A set of parameters that applies to the connectivity from a
                certain node and port to another node or port or to one or
                more reachable address prefixes and/or transit networks,
                for one (or more) particular service category(s). Note
                that there can be multiple sets of parameters with the same
                tag, in which case all sets apply to the specified
                connectivity."
REFERENCE      "ATM Forum PNNI 1.1 Section 5.8.1.1.3"
INDEX          { pnniNodeIndex,
                pnniMetricsTag,
                pnniMetricsDirection,
                pnniMetricsIndex }
 ::= { pnniMetricsTable 1 }

PnniMetricsEntry ::=
SEQUENCE {
    pnniMetricsTag          PnniMetricsTag,
    pnniMetricsDirection   INTEGER,
    pnniMetricsIndex       Integer32,
    pnniMetricsClasses     INTEGER,
    pnniMetricsGcacClp     ClpType,
    pnniMetricsAdminWeight Unsigned32,
    pnniMetrics1           Unsigned32,

```

```

pnniMetrics2           Unsigned32,
pnniMetrics3           Unsigned32,
pnniMetrics4           Unsigned32,
pnniMetrics5           Unsigned32,
pnniMetrics6           Unsigned32,
pnniMetrics7           Unsigned32,
pnniMetrics8           Unsigned32,
pnniMetricsRowStatus   RowStatus,
pnniMetricsAvcrIndicatorForUbr TruthValue,
pnniMetrics9           Unsigned32,
pnniMetricsGfrCapability GfrCapability,
pnniMetrics10          Unsigned32
}

```

pnniMetricsTag OBJECT-TYPE

```
SYNTAX      PnniMetricsTag (1..2147483647)
```

```
MAX-ACCESS  not-accessible
```

```
STATUS      current
```

DESCRIPTION

"An arbitrary integer that is used to associate a set of traffic parameters that are always advertised together. Within this set, the parameters are distinguished by the service categories and direction to which a set of parameters apply."

```
::= { pnniMetricsEntry 1 }
```

pnniMetricsDirection OBJECT-TYPE

```
SYNTAX      INTEGER { incoming(1), outgoing(2) }
```

```
MAX-ACCESS  not-accessible
```

```
STATUS      current
```

DESCRIPTION

"The direction, with respect to the advertising node, in which the parameters in this entry apply."

```
::= { pnniMetricsEntry 2 }
```

pnniMetricsIndex OBJECT-TYPE

```
SYNTAX      Integer32 (1..2147483647)
```

```
MAX-ACCESS  not-accessible
```

```
STATUS      current
```

DESCRIPTION

"An index into the set of parameters associated with the given tag and direction."

```
::= { pnniMetricsEntry 3 }
```

pnniMetricsClasses OBJECT-TYPE

```
SYNTAX      INTEGER(0..63)
```

```
MAX-ACCESS  read-create
```

```
STATUS      current
```

DESCRIPTION

"The service categories to which this set of parameters applies. This is an integer used as a bit mask with each bit that is set representing a single service category for which the resources indicated are available. Bit 6 represents GFR, bit 5 represents CBR, bit 4 represents real-time VBR, bit 3 represents non-real-time VBR, bit 2 represents ABR, and bit 1 (LSB) represents UBR."

REFERENCE

"ATM Forum Traffic Management 4.1 Section 2,
 ATM Forum PNNI 1.1 Section 5.8.1.1.3.1,
 ATM Forum Guaranteed Frame Rate (GFR) Signalling Specification
 (PNNI, AINI, and UNI), Version 1.0 Section 4.2"

::= { pnniMetricsEntry 4 }

pnniMetricsGcacClp OBJECT-TYPE

SYNTAX ClpType
 MAX-ACCESS read-create
 STATUS current

DESCRIPTION

"Indicates whether the advertised GCAC parameters apply for
 CLP=0 traffic or for CLP=0+1 traffic."

REFERENCE

"ATM Forum PNNI 1.1 Sections 5.8.1.1.3.1, 5.13.4.1"

::= { pnniMetricsEntry 5 }

pnniMetricsAdminWeight OBJECT-TYPE

SYNTAX Unsigned32 (1..16777215)
 MAX-ACCESS read-create
 STATUS current

DESCRIPTION

"The administrative weight from the advertising node to the
 remote end of the PNNI entity or to the reachable address
 or transit network, for the specified service categories."

REFERENCE

"ATM Forum PNNI 1.1 Section 5.8.1.1.3.4"

DEFVAL { 5040 }

::= { pnniMetricsEntry 6 }

pnniMetrics1 OBJECT-TYPE

SYNTAX Unsigned32
 MAX-ACCESS read-create
 STATUS current

DESCRIPTION

"An alternate routing parameter from the advertising node to
 the remote end of the PNNI entity or to the reachable
 address or transit network, for the specified service
 categories.

For information learned from PNNI nodes, this is the
 maximum cell rate in cells per second for the specified
 service categories.

If this parameter is not used, its value should be set to
 0xFFFFFFFF."

REFERENCE

"ATM Forum PNNI 1.1 Section 5.8.1.1.3.7"

DEFVAL { 'FFFFFFFF'h }

::= { pnniMetricsEntry 7 }

pnniMetrics2 OBJECT-TYPE

SYNTAX Unsigned32
 MAX-ACCESS read-create
 STATUS current

DESCRIPTION

"An alternate routing parameter from the advertising node to

the remote end of the PNNI entity or to the reachable address or transit network, for the specified service categories.

For information learned from PNNI nodes, this is the available cell rate in cells per second for the specified service categories.

If this parameter is not used, its value should be set to 0xFFFFFFFF."

REFERENCE

"ATM Forum PNNI 1.1 Section 5.8.1.1.3.8"

```
DEFVAL { 'FFFFFFFF'h }
 ::= { pnniMetricsEntry 8 }
```

pnniMetrics3 OBJECT-TYPE

```
SYNTAX      Unsigned32
MAX-ACCESS  read-create
STATUS      current
DESCRIPTION
```

"An alternate routing parameter from the advertising node to the remote end of the PNNI entity or to the reachable address or transit network, for the specified service categories.

For information learned from PNNI nodes, this is the maximum cell transfer delay in microseconds for the specified service categories.

If this parameter is not used, its value should be set to 0xFFFFFFFF."

REFERENCE

"ATM Forum PNNI 1.1 Section 5.8.1.1.3.3"

```
DEFVAL { 'FFFFFFFF'h }
 ::= { pnniMetricsEntry 9 }
```

pnniMetrics4 OBJECT-TYPE

```
SYNTAX      Unsigned32
MAX-ACCESS  read-create
STATUS      current
DESCRIPTION
```

"An alternate routing parameter from the advertising node to the remote end of the PNNI entity or to the reachable address or transit network, for the specified service categories.

For information learned from PNNI nodes, this is the cell delay variation in microseconds for the specified service categories.

If this parameter is not used, its value should be set to 0xFFFFFFFF."

REFERENCE

"ATM Forum PNNI 1.1 Section 5.8.1.1.3.2"

```
DEFVAL { 'FFFFFFFF'h }
 ::= { pnniMetricsEntry 10 }
```

pnniMetrics5 OBJECT-TYPE

```

SYNTAX          Unsigned32
MAX-ACCESS      read-create
STATUS          current
DESCRIPTION
    "An alternate routing parameter from the advertising node to
    the remote end of the PNNI entity or to the reachable
    address or transit network, for the specified service
    categories.

    For PNNI, this is the cell loss ratio for CLP=0 traffic for
    the specified service categories. The cell loss ratio
    value is computed as 10**(-n) where 'n' is the value
    returned in this variable.

    If this parameter is not used, its value should be set to
    0xFFFFFFFF."
REFERENCE
    "ATM Forum PNNI 1.1 Section 5.8.1.1.3.5"
DEFVAL { 'FFFFFFFF'h }
 ::= { pnniMetricsEntry 11 }

```

pnniMetrics6 OBJECT-TYPE

```

SYNTAX          Unsigned32
MAX-ACCESS      read-create
STATUS          current
DESCRIPTION
    "An alternate routing parameter from the advertising node to
    the remote end of the PNNI entity or to the reachable
    address or transit network, for the specified service
    categories.

    For PNNI, this is the cell loss ratio for CLP=0+1 traffic
    for the specified service categories. The cell loss ratio
    value is computed as 10**(-n) where 'n' is the value
    returned in this variable.

    If this parameter is not used, its value should be set to
    0xFFFFFFFF."
REFERENCE
    "ATM Forum PNNI 1.1 Section 5.8.1.1.3.6"
DEFVAL { 'FFFFFFFF'h }
 ::= { pnniMetricsEntry 12 }

```

pnniMetrics7 OBJECT-TYPE

```

SYNTAX          Unsigned32
MAX-ACCESS      read-create
STATUS          current
DESCRIPTION
    "An alternate routing parameter from the advertising node to
    the remote end of the PNNI entity or to the reachable
    address or transit network, for the specified service
    categories.

    For information learned from PNNI nodes, this is the cell
    rate margin in cells per second for the specified service
    categories.

    If this parameter is not used, its value should be set to
    0xFFFFFFFF."
REFERENCE

```

"ATM Forum PNNI 1.1 Section 5.8.1.1.3.9"
 DEFVAL { 'FFFFFFFF'h }
 ::= { pnniMetricsEntry 13 }

pnniMetrics8 OBJECT-TYPE

SYNTAX Unsigned32
 MAX-ACCESS read-create
 STATUS current

DESCRIPTION

"An alternate routing parameter from the advertising node to the remote end of the PNNI entity or to the reachable address or transit network, for the specified service categories.

For information learned from PNNI nodes, this is the variance factor in units of $2^{*(-8)}$ for the specified service categories.

If this parameter is not used, its value should be set to 0xFFFFFFFF."

REFERENCE

"ATM Forum PNNI 1.1 Section 5.8.1.1.3.10"

DEFVAL { 'FFFFFFFF'h }
 ::= { pnniMetricsEntry 14 }

pnniMetricsRowStatus OBJECT-TYPE

SYNTAX RowStatus
 MAX-ACCESS read-create
 STATUS current

DESCRIPTION

"To create, delete, activate and de-activate a set of metrics."

::= { pnniMetricsEntry 15 }

pnniMetricsAvcrIndicatorForUbr OBJECT-TYPE

SYNTAX TruthValue
 MAX-ACCESS read-create
 STATUS current

DESCRIPTION

"When bit 1 (UBR) of pnniMetricsClasses is set to one, this object reflects the value of the AvCR indicator for UBR. In this case, when the value of this object is 'true', then pnniMetrics2 provides a measure of the capacity not reserved for service commitments. When the value of this object is 'false', then pnniMetrics2 is not applicable to the UBR service category.

This object does not apply when bit 1 (UBR) of pnniMetricsClasses is set to zero."

REFERENCE

"UBR with MDCR Addendum to UNI Signalling 4.0, PNNI 1.0 and AINI Section 5.3 Clause 5.8.1.1.3.8/PNNI 1.1"

::= { pnniMetricsEntry 16 }

pnniMetrics9 OBJECT-TYPE

SYNTAX Unsigned32
 MAX-ACCESS read-create
 STATUS current

DESCRIPTION

"An alternate routing parameter from the advertising node to the remote end of the PNNI entity or to the reachable address or transit network, for the specified service categories.

For information learned from PNNI nodes, this is the BeCR in cells per second. This value is applicable only when bit 1 of pnniMetricsClasses is set to 1.

If this parameter is not used, its value should be set to 0xFFFFFFFF."

REFERENCE

"UBR with MDCR Addendum to UNI Signalling 4.0, PNNI 1.0 and AINI"
 ::= { pnniMetricsEntry 17 }

pnniMetricsGfrCapability OBJECT-TYPE

SYNTAX GfrCapability
 MAX-ACCESS read-create
 STATUS current

DESCRIPTION

"When bit 6 of the of the pnniMetricsClasses is set to one this object indicates the GFR Conformance definitions supported. This object does not apply when bit 6 of the pnniMetricsClasses is set to zero."

REFERENCE

"ATM Forum Guaranteed Frame Rate (GFR) Signalling Specification (PNNI, AINI, and UNI), Version 1.0 Section 4.2"
 ::= { pnniMetricsEntry 18 }

pnniMetrics10 OBJECT-TYPE

SYNTAX Unsigned32
 MAX-ACCESS read-create
 STATUS current

DESCRIPTION

"An alternate routing parameter from the advertising node to the remote end of the PNNI entity or to the reachable address or transit network, for the specified service categories.

For information learned from PNNI nodes, this is the AccBCT expressed in units of cells. This value is applicable only for the GFR service category.

If this parameter is not used, its value should be set to 0xFFFFFFFF."

REFERENCE

"ATM Forum Guaranteed Frame Rate (GFR) Signalling Specification (PNNI, AINI, and UNI), Version 1.0 Section 4.2"
 ::= { pnniMetricsEntry 19 }

--

-- PNNI Routing Tables

--

pnniRoutingGroup OBJECT IDENTIFIER ::= { pnniMIBObjects 19 }
 pnniRouteBaseGroup OBJECT IDENTIFIER ::= { pnniRoutingGroup 1 }

pnniRouteNodeNumber OBJECT-TYPE

SYNTAX Gauge32
 MAX-ACCESS read-only
 STATUS current

```

DESCRIPTION
    "The number of current precalculated PNNI routes to PNNI
    nodes that are not invalid."
 ::= { pnniRouteBaseGroup 1 }

pnniRouteAddrNumber OBJECT-TYPE
    SYNTAX      Gauge32
    MAX-ACCESS  read-only
    STATUS      current
    DESCRIPTION
        "The number of current PNNI routes from nodes in the PNNI
        routing domain to addresses and transit networks that are
        not invalid."
 ::= { pnniRouteBaseGroup 2 }

-- Table of routes to other nodes

pnniRouteNodeTable OBJECT-TYPE
    SYNTAX      SEQUENCE OF PnniRouteNodeEntry
    MAX-ACCESS  not-accessible
    STATUS      current
    DESCRIPTION
        "This entity's PNNI Routing table (of routes to other
        nodes). "
 ::= { pnniRoutingGroup 2 }

pnniRouteNodeEntry OBJECT-TYPE
    SYNTAX      PnniRouteNodeEntry
    MAX-ACCESS  not-accessible
    STATUS      current
    DESCRIPTION
        "A particular route to a particular destination node, under
        a particular policy."
    INDEX       { pnniNodeIndex,
                  pnniRouteNodeClass,
                  pnniRouteNodeDestNodeId,
                  pnniRouteNodeDTL }
 ::= { pnniRouteNodeTable 1 }

PnniRouteNodeEntry ::=
    SEQUENCE {
        pnniRouteNodeClass      ServiceCategory,
        pnniRouteNodeDestNodeId PnniNodeId,
        pnniRouteNodeDTL        Integer32,
        pnniRouteNodeDestPortId PnniPortId,
        pnniRouteNodeProto      INTEGER,
        pnniRouteNodeTimeStamp  TimeStamp,
        pnniRouteNodeInfo       OBJECT IDENTIFIER,
        pnniRouteNodeGcacClp    ClpType,
        pnniRouteNodeFwdMetricAW Unsigned32,
        pnniRouteNodeFwdMetric1 Unsigned32,
        pnniRouteNodeFwdMetric2 Unsigned32,
        pnniRouteNodeFwdMetric3 Unsigned32,
        pnniRouteNodeFwdMetric4 Unsigned32,
        pnniRouteNodeFwdMetric5 Unsigned32,
        pnniRouteNodeFwdMetric6 Unsigned32,
        pnniRouteNodeFwdMetric7 Unsigned32,
        pnniRouteNodeFwdMetric8 Unsigned32,
        pnniRouteNodeBwdMetricAW Unsigned32,

```

```

pnniRouteNodeBwdMetric1 Unsigned32,
pnniRouteNodeBwdMetric2 Unsigned32,
pnniRouteNodeBwdMetric3 Unsigned32,
pnniRouteNodeBwdMetric4 Unsigned32,
pnniRouteNodeBwdMetric5 Unsigned32,
pnniRouteNodeBwdMetric6 Unsigned32,
pnniRouteNodeBwdMetric7 Unsigned32,
pnniRouteNodeBwdMetric8 Unsigned32,
pnniRouteNodeVPCapability TruthValue,
pnniRouteNodeStatus RowStatus,
pnniRouteNodeGfrCapability GfrCapability
}

```

pnniRouteNodeClass OBJECT-TYPE

```

SYNTAX      ServiceCategory
MAX-ACCESS  not-accessible
STATUS      current

```

DESCRIPTION

"Indicates the service category with which this forwarding table entry is associated."

```
 ::= { pnniRouteNodeEntry 1 }
```

pnniRouteNodeDestNodeId OBJECT-TYPE

```

SYNTAX      PnniNodeId
MAX-ACCESS  not-accessible
STATUS      current

```

DESCRIPTION

"The node ID of the destination node to which this route proceeds, and at which the DTL stack for this route terminates."

```
 ::= { pnniRouteNodeEntry 2 }
```

pnniRouteNodeDTL OBJECT-TYPE

```

SYNTAX      Integer32 (1..2147483647)
MAX-ACCESS  not-accessible
STATUS      current

```

DESCRIPTION

"The index into the owning PNNI node's DTL table of the DTL stack that goes with this route."

```
 ::= { pnniRouteNodeEntry 3 }
```

pnniRouteNodeDestPortId OBJECT-TYPE

```

SYNTAX      PnniPortId
MAX-ACCESS  read-create
STATUS      current

```

DESCRIPTION

"The port ID of the destination node at which the route terminates. A port ID of zero indicates the node nucleus. When the destination node is represented by the simple node representation, this value should be set to zero."

```
 DEFVAL { 0 }
```

```
 ::= { pnniRouteNodeEntry 4 }
```

pnniRouteNodeProto OBJECT-TYPE

```

SYNTAX      INTEGER {
                other(1), -- not specified
                local(2), -- e.g. ilmi
                mgmt(3), -- configured by management,
                        -- for example by SNMP or console
                        -- the following are all dynamic
            }

```

```

-- routing protocols
pnni(4) -- ATM Forum PNNI
}
MAX-ACCESS    read-only
STATUS        current
DESCRIPTION
    "The routing mechanism via which this route was learned."
 ::= { pnniRouteNodeEntry 5 }

pnniRouteNodeTimeStamp OBJECT-TYPE
SYNTAX        TimeStamp
MAX-ACCESS    read-only
STATUS        current
DESCRIPTION
    "The time at which this route was last updated or
    otherwise determined to be correct. Note that no
    semantics of `too old' can be implied except through
    knowledge of the routing protocol by which the route
    was learned."
 ::= { pnniRouteNodeEntry 6 }

pnniRouteNodeInfo OBJECT-TYPE
SYNTAX        OBJECT IDENTIFIER
MAX-ACCESS    read-create
STATUS        current
DESCRIPTION
    "A reference to MIB definitions specific to the particular
    routing protocol which is responsible for this route, as
    determined by the value specified in the route's
    pnniRouteNodeProto value. If this information is not
    present, its value should be set to the OBJECT IDENTIFIER
    zeroDotZero."
DEFVAL { zeroDotZero }
 ::= { pnniRouteNodeEntry 7 }

pnniRouteNodeGcacClp OBJECT-TYPE
SYNTAX        ClpType
MAX-ACCESS    read-create
STATUS        current
DESCRIPTION
    "For PNNI, indicates whether any advertised GCAC parameters
    apply for CLP=0 traffic or for CLP=0+1 traffic."
 ::= { pnniRouteNodeEntry 8 }

pnniRouteNodeFwdMetricAW OBJECT-TYPE
SYNTAX        Unsigned32
MAX-ACCESS    read-create
STATUS        current
DESCRIPTION
    "The cumulative administrative weight calculated for the
    forward direction of this route. If this metric is not
    used, its value should be set to 0xFFFFFFFF."
REFERENCE
    "ATM Forum PNNI 1.1 Section 5.8.1.1.3.4"
DEFVAL { 'FFFFFFFF'h }
 ::= { pnniRouteNodeEntry 9 }

pnniRouteNodeFwdMetricI1 OBJECT-TYPE
SYNTAX        Unsigned32
MAX-ACCESS    read-create
STATUS        current

```

DESCRIPTION

"An alternate routing parameter for the forward direction of this route.

For information learned from PNNI nodes, this is the maximum possible cell rate (in cells per second) for the forward direction of the route.

If this parameter is not used, its value should be set to 0xFFFFFFFF."

REFERENCE

"ATM Forum PNNI 1.1 Section 5.8.1.1.3.7"

DEFVAL { 'FFFFFFFF'h }
::= { pnniRouteNodeEntry 10 }

pnniRouteNodeFwdMetric2 OBJECT-TYPE

SYNTAX Unsigned32
MAX-ACCESS read-create
STATUS current

DESCRIPTION

"An alternate routing parameter for the forward direction of this route.

For information learned from PNNI nodes, this is the Available cell rate (in cells per second) for the forward direction of the route. Further information on available bandwidth may be obtainable by reference to the nodal advertisements of the nodes in the path.

If this parameter is not used, its value should be set to 0xFFFFFFFF."

REFERENCE

"ATM Forum PNNI 1.1 Section 5.8.1.1.3.8"

DEFVAL { 'FFFFFFFF'h }
::= { pnniRouteNodeEntry 11 }

pnniRouteNodeFwdMetric3 OBJECT-TYPE

SYNTAX Unsigned32
MAX-ACCESS read-create
STATUS current

DESCRIPTION

"An alternate routing parameter for the forward direction of this route.

For information learned from PNNI nodes, this is the cumulative Maximum Cell Transfer Delay (in microseconds) for the forward direction of the route.

If this parameter is not used, its value should be set to 0xFFFFFFFF."

REFERENCE

"ATM Forum PNNI 1.1 Section 5.8.1.1.3.3"

DEFVAL { 'FFFFFFFF'h }
::= { pnniRouteNodeEntry 12 }

pnniRouteNodeFwdMetric4 OBJECT-TYPE

SYNTAX Unsigned32
MAX-ACCESS read-create
STATUS current

DESCRIPTION

"An alternate routing parameter for the forward direction of

this route.

For information learned from PNNI nodes, this is the cumulative Cell Delay Variation (in microseconds) for the forward direction of the route.

If this parameter is not used, its value should be set to 0xFFFFFFFF."

REFERENCE

"ATM Forum PNNI 1.1 Section 5.8.1.1.3.2"

DEFVAL { 'FFFFFFFF'h }
 ::= { pnniRouteNodeEntry 13 }

pnniRouteNodeFwdMetric5 OBJECT-TYPE

SYNTAX Unsigned32
 MAX-ACCESS read-create
 STATUS current

DESCRIPTION

"An alternate routing parameter for the forward direction of this route.

For information learned from PNNI nodes, this is the cumulative Cell Loss Ratio for CLP=0 traffic for the forward direction of the route. The cell loss ratio value is computed as $10^{*(-n)}$ where 'n' is the value returned in this variable.

If this parameter is not used, its value should be set to 0xFFFFFFFF."

REFERENCE

"ATM Forum PNNI 1.1 Section 5.8.1.1.3.5"

DEFVAL { 'FFFFFFFF'h }
 ::= { pnniRouteNodeEntry 14 }

pnniRouteNodeFwdMetric6 OBJECT-TYPE

SYNTAX Unsigned32
 MAX-ACCESS read-create
 STATUS current

DESCRIPTION

"An alternate routing parameter for the forward direction of this route.

For information learned from PNNI nodes, this is the cumulative Cell Loss Ratio for CLP=0+1 traffic for the forward direction of the route. The cell loss ratio value is computed as $10^{*(-n)}$ where 'n' is the value returned in this variable.

If this parameter is not used, its value should be set to 0xFFFFFFFF."

REFERENCE

"ATM Forum PNNI 1.1 Section 5.8.1.1.3.6"

DEFVAL { 'FFFFFFFF'h }
 ::= { pnniRouteNodeEntry 15 }

pnniRouteNodeFwdMetric7 OBJECT-TYPE

SYNTAX Unsigned32
 MAX-ACCESS read-create
 STATUS current

DESCRIPTION

"An alternate routing parameter for the forward direction of this route.

For information learned from PNNI nodes, this is the Cell Rate Margin (in cells per second) for the forward direction of the route.

If this parameter is not used, its value should be set to 0xFFFFFFFF."

REFERENCE

"ATM Forum PNNI 1.1 Section 5.8.1.1.3.9"

DEFVAL { 'FFFFFFFF'h }
 ::= { pnniRouteNodeEntry 16 }

pnniRouteNodeFwdMetric8 OBJECT-TYPE

SYNTAX Unsigned32
 MAX-ACCESS read-create
 STATUS current
 DESCRIPTION

"An alternate routing parameter for the forward direction of this route.

For information learned from PNNI nodes, this is the Variance Factor (in units of 2**(-8)) for the forward direction of the route.

If this parameter is not used, its value should be set to 0xFFFFFFFF."

REFERENCE

"ATM Forum PNNI 1.1 Section 5.8.1.1.3.10"

DEFVAL { 'FFFFFFFF'h }
 ::= { pnniRouteNodeEntry 17 }

pnniRouteNodeBwdMetricAW OBJECT-TYPE

SYNTAX Unsigned32
 MAX-ACCESS read-create
 STATUS current
 DESCRIPTION

"The administrative weight calculated for the backward direction of this route. If this metric is not used, its value should be set to 0xFFFFFFFF."

REFERENCE

"ATM Forum PNNI 1.1 Section 5.8.1.1.3.4"

DEFVAL { 'FFFFFFFF'h }
 ::= { pnniRouteNodeEntry 18 }

pnniRouteNodeBwdMetric1 OBJECT-TYPE

SYNTAX Unsigned32
 MAX-ACCESS read-create
 STATUS current
 DESCRIPTION

"An alternate routing parameter for the backward direction of this route.

For information learned from PNNI nodes, this is the maximum possible cell rate (in cells per second) for the backward direction of the route.

If this parameter is not used, its value should be set to 0xFFFFFFFF."

REFERENCE

"ATM Forum PNNI 1.1 Section 5.8.1.1.3.7"
 DEFVAL { 'FFFFFFFF'h }
 ::= { pnniRouteNodeEntry 19 }

pnniRouteNodeBwdMetric2 OBJECT-TYPE

SYNTAX Unsigned32
 MAX-ACCESS read-create
 STATUS current
 DESCRIPTION

"An alternate routing parameter for the backward direction of this route.

For information learned from PNNI nodes, this is the Available cell rate (in cells per second) for the backward direction of the route. Further information on available bandwidth may be obtainable by reference to the nodal advertisements of the nodes in the path.

If this parameter is not used, its value should be set to 0xFFFFFFFF."

REFERENCE

"ATM Forum PNNI 1.1 Section 5.8.1.1.3.8"

DEFVAL { 'FFFFFFFF'h }
 ::= { pnniRouteNodeEntry 20 }

pnniRouteNodeBwdMetric3 OBJECT-TYPE

SYNTAX Unsigned32
 MAX-ACCESS read-create
 STATUS current
 DESCRIPTION

"An alternate routing parameter for the backward direction of this route.

For information learned from PNNI nodes, this is the cumulative Maximum Cell Transfer Delay (in microseconds) for the backward direction of the route.

If this parameter is not used, its value should be set to 0xFFFFFFFF."

REFERENCE

"ATM Forum PNNI 1.1 Section 5.8.1.1.3.3"

DEFVAL { 'FFFFFFFF'h }
 ::= { pnniRouteNodeEntry 21 }

pnniRouteNodeBwdMetric4 OBJECT-TYPE

SYNTAX Unsigned32
 MAX-ACCESS read-create
 STATUS current
 DESCRIPTION

"An alternate routing parameter for the backward direction of this route.

For information learned from PNNI nodes, this is the cumulative Cell Delay Variation (in microseconds) for the backward direction of the route.

If this parameter is not used, its value should be set to 0xFFFFFFFF."

REFERENCE

"ATM Forum PNNI 1.1 Section 5.8.1.1.3.2"

DEFVAL { 'FFFFFFFF'h }

```
 ::= { pnniRouteNodeEntry 22 }
```

pnniRouteNodeBwdMetric5 OBJECT-TYPE

SYNTAX Unsigned32

MAX-ACCESS read-create

STATUS current

DESCRIPTION

"An alternate routing parameter for the backward direction of this route.

For information learned from PNNI nodes, this is the cumulative Cell Loss Ratio for CLP=0 traffic for the backward direction of the route. The cell loss ratio value is computed as $10^{*(-n)}$ where 'n' is the value returned in this variable.

If this parameter is not used, its value should be set to 0xFFFFFFFF."

REFERENCE

"ATM Forum PNNI 1.1 Section 5.8.1.1.3.5"

DEFVAL { 'FFFFFFFF'h }

```
 ::= { pnniRouteNodeEntry 23 }
```

pnniRouteNodeBwdMetric6 OBJECT-TYPE

SYNTAX Unsigned32

MAX-ACCESS read-create

STATUS current

DESCRIPTION

"An alternate routing parameter for the backward direction of this route.

For information learned from PNNI nodes, this is the cumulative Cell Loss Ratio for CLP=0+1 traffic for the backward direction of the route. The cell loss ratio value is computed as $10^{*(-n)}$ where 'n' is the value returned in this variable.

If this parameter is not used, its value should be set to 0xFFFFFFFF."

REFERENCE

"ATM Forum PNNI 1.1 Section 5.8.1.1.3.6"

DEFVAL { 'FFFFFFFF'h }

```
 ::= { pnniRouteNodeEntry 24 }
```

pnniRouteNodeBwdMetric7 OBJECT-TYPE

SYNTAX Unsigned32

MAX-ACCESS read-create

STATUS current

DESCRIPTION

"An alternate routing parameter for the backward direction of this route.

For information learned from PNNI nodes, this is the Cell Rate Margin (in cells per second) for the backward direction of the route.

If this parameter is not used, its value should be set to 0xFFFFFFFF."

REFERENCE

"ATM Forum PNNI 1.1 Section 5.8.1.1.3.9"

```
DEFVAL { 'FFFFFFFF'h }
::= { pnniRouteNodeEntry 25 }
```

pnniRouteNodeBwdMetric8 OBJECT-TYPE

```
SYNTAX      Unsigned32
MAX-ACCESS  read-create
STATUS      current
DESCRIPTION
    "An alternate routing parameter for the backward direction
    of this route.

    For information learned from PNNI nodes, this is the
    Variance Factor (in units of 2**(-8)) for the backward
    direction of the route.

    If this parameter is not used, its value should be set to
    0xFFFFFFFF."
```

REFERENCE

"ATM Forum PNNI 1.1 Section 5.8.1.1.3.10"

```
DEFVAL { 'FFFFFFFF'h }
::= { pnniRouteNodeEntry 26 }
```

pnniRouteNodeVPCapability OBJECT-TYPE

```
SYNTAX      TruthValue
MAX-ACCESS  read-create
STATUS      current
DESCRIPTION
    "This attribute indicates whether a VPC setup on this route
    is possible."
::= { pnniRouteNodeEntry 27 }
```

pnniRouteNodeStatus OBJECT-TYPE

```
SYNTAX      RowStatus
MAX-ACCESS  read-create
STATUS      current
DESCRIPTION
    "The row status variable, used according to row installation
    and removal conventions."
::= { pnniRouteNodeEntry 28 }
```

pnniRouteNodeGfrCapability OBJECT-TYPE

```
SYNTAX      GfrCapability
MAX-ACCESS  read-create
STATUS      current
DESCRIPTION
    "When pnniRouteNodeClass is set to 'gfr', this object
    indicates the GFR conformance definitions supported
    on this route. This object does not apply when the
    pnniRouteNodeClass is set to any other value than 'gfr'."
REFERENCE
    "ATM Forum Guaranteed Frame Rate (GFR) Signalling Specification
    (PNNI, AINI, and UNI), Version 1.0 Section 4.2"
::= { pnniRouteNodeEntry 29 }
```

-- Table of DTL stacks for routes to other nodes

pnniDTLTable OBJECT-TYPE

```
SYNTAX      SEQUENCE OF PnniDTLEntry
MAX-ACCESS  not-accessible
STATUS      current
```

DESCRIPTION

"The set of all DTL stacks used for the pre-computed routes maintained by this managed entity."

::= { pnniRoutingGroup 3 }

pnniDTLEntry OBJECT-TYPE

SYNTAX PnniDTLEntry
MAX-ACCESS not-accessible
STATUS current

DESCRIPTION

"A segment of a DTL stack. The complete DTL stack is formed by traversing the rows of the table for which the pnniDTLIndex is the same. Level transitions are indicated using the pnniDTLLinkType column."

INDEX {
 pnniNodeIndex,
 pnniDTLIndex,
 pnniDTLEntryIndex
}
::= { pnniDTLTable 1 }

PnniDTLEntry ::=

SEQUENCE {
 pnniDTLIndex Integer32,
 pnniDTLEntryIndex Integer32,
 pnniDTLNodeId PnniNodeId,
 pnniDTLPortId PnniPortId,
 pnniDTLLinkType INTEGER,
 pnniDTLStatus RowStatus
}

pnniDTLIndex OBJECT-TYPE

SYNTAX Integer32 (1..2147483647)
MAX-ACCESS not-accessible
STATUS current

DESCRIPTION

"The index in the node's DTL table of this DTL stack."

::= { pnniDTLEntry 1 }

pnniDTLEntryIndex OBJECT-TYPE

SYNTAX Integer32 (1..200)
MAX-ACCESS not-accessible
STATUS current

DESCRIPTION

"The index in the current DTL stack of this entry."

::= { pnniDTLEntry 2 }

pnniDTLNodeId OBJECT-TYPE

SYNTAX PnniNodeId
MAX-ACCESS read-create
STATUS current

DESCRIPTION

"The node which is this hop in the DTL stack."

::= { pnniDTLEntry 3 }

pnniDTLPortId OBJECT-TYPE

SYNTAX PnniPortId
MAX-ACCESS read-create
STATUS current

DESCRIPTION

"The port from the pnniDTLNodeId to use as the exit. If the

DTL stack does not care, this is coded as zero."
 ::= { pnniDTLEntry 4 }

```

pnniDTLLinkType OBJECT-TYPE
    SYNTAX          INTEGER {
        invalid      (1), -- An invalid link
        horizontal   (2), -- A normal link within
                        -- the containing peer group
        uplink       (3), -- A link going up a
                        -- level
        last          (4) -- The last entry in the
                        -- DTL stack
    }
    MAX-ACCESS      read-create
    STATUS          current
    DESCRIPTION
        "The type of link out from this node (pnniDTLNodeId). This
        is well defined even if the specific port is not
        specified."
    ::= { pnniDTLEntry 5 }
  
```

```

pnniDTLStatus OBJECT-TYPE
    SYNTAX          RowStatus
    MAX-ACCESS      read-create
    STATUS          current
    DESCRIPTION
        "The row status variable, used according to row installation
        and removal conventions."
    ::= { pnniDTLEntry 6 }
  
```

-- Table of routes from nodes to reachable addresses

```

pnniRouteAddrTable OBJECT-TYPE
    SYNTAX          SEQUENCE OF PnniRouteAddrEntry
    MAX-ACCESS      not-accessible
    STATUS          current
    DESCRIPTION
        "A table containing all the attributes necessary to
        determine what the PNNI entity believes is reachable in
        terms of ATM End System Addresses and to determine which
        nodes are advertising this reachability. This table is
        also used to configure static routes to reachable address
        prefixes. The local node index that received the
        reachability information, reachable address, address prefix
        length, and an index that distinguishes between multiple
        listings of connectivity to a given address prefix from a
        given local node are combined to form an instance ID for
        this object."
    REFERENCE
        "ATM Forum PNNI 1.1 Section 5.8.1.3"
    ::= { pnniRoutingGroup 4 }
  
```

```

pnniRouteAddrEntry OBJECT-TYPE
    SYNTAX          PnniRouteAddrEntry
    MAX-ACCESS      not-accessible
    STATUS          current
    DESCRIPTION
        "An entry in the table, containing information about a
        reachable address prefix."
    REFERENCE
  
```

```

"ATM Forum PNNI 1.1 Section 5.8.1.3"
INDEX      { pnniNodeIndex,
             pnniRouteAddrAddress,
             pnniRouteAddrPrefixLength,
             pnniRouteAddrIndex }
 ::= { pnniRouteAddrTable 1 }
PnniRouteAddrEntry ::=
SEQUENCE {
    pnniRouteAddrAddress      AtmAddrPrefix,
    pnniRouteAddrPrefixLength PnniPrefixLength,
    pnniRouteAddrIndex        Integer32,
    pnniRouteAddrIfIndex      InterfaceIndex,
    pnniRouteAddrAdvertisingNodeId PnniNodeId,
    pnniRouteAddrAdvertisedPortId PnniPortId,
    pnniRouteAddrType          INTEGER,
    pnniRouteAddrProto          INTEGER,
    pnniRouteAddrPnniScope     PnniLevel,
    pnniRouteAddrVPCapability  TruthValue,
    pnniRouteAddrMetricsTag    PnniMetricsTag,
    pnniRouteAddrPtseId        Unsigned32,
    pnniRouteAddrOriginateAdvertisement TruthValue,
    pnniRouteAddrInfo          OBJECT IDENTIFIER,
    pnniRouteAddrOperStatus    INTEGER,
    pnniRouteAddrTimeStamp     TimeStamp,
    pnniRouteAddrRowStatus     RowStatus
}
pnniRouteAddrAddress OBJECT-TYPE
SYNTAX      AtmAddrPrefix
MAX-ACCESS  not-accessible
STATUS      current
DESCRIPTION
    "The value of the ATM End System Address prefix."
 ::= { pnniRouteAddrEntry 1 }

pnniRouteAddrPrefixLength OBJECT-TYPE
SYNTAX      PnniPrefixLength
MAX-ACCESS  not-accessible
STATUS      current
DESCRIPTION
    "The prefix length to be applied to the ATM End System
    Address prefix."
 ::= { pnniRouteAddrEntry 2 }

pnniRouteAddrIndex OBJECT-TYPE
SYNTAX      Integer32 (1..65535)
MAX-ACCESS  not-accessible
STATUS      current
DESCRIPTION
    "An index into the set of listings of connectivity to a
    given address prefix from a given local node."
 ::= { pnniRouteAddrEntry 3 }

pnniRouteAddrIfIndex OBJECT-TYPE
SYNTAX      InterfaceIndex
MAX-ACCESS  read-create
STATUS      current
DESCRIPTION
    "The local interface over which the reachable address can be
    reached. The value zero indicates an unknown interface or
    reachability through a remote node."

```

This object may only have a non-zero value if the value of the corresponding instance of pnniRouteAddrProto is other than 'pnni', pnniRouteAddrType is other than 'reject', and the node identified by pnniRouteAddrAdvertisingNodeId is instantiated within this switching system."

```
 ::= { pnniRouteAddrEntry 4 }
```

pnniRouteAddrAdvertisingNodeId OBJECT-TYPE
 SYNTAX PnniNodeId
 MAX-ACCESS read-create
 STATUS current
 DESCRIPTION
 "The node ID of a node advertising reachability to the address prefix. If the local node index is zero, then the advertising node ID must be set to all zeros."
 ::= { pnniRouteAddrEntry 5 }

pnniRouteAddrAdvertisedPortId OBJECT-TYPE
 SYNTAX PnniPortId
 MAX-ACCESS read-create
 STATUS current
 DESCRIPTION
 "The port identifier used from the advertising node to reach the given address prefix."
 DEFVAL { 0 }
 ::= { pnniRouteAddrEntry 6 }

pnniRouteAddrType OBJECT-TYPE
 SYNTAX INTEGER {
 other(1), -- not specified by this MIB
 reject(2), -- route which discards
 -- traffic
 internal(3),
 exterior(4)
 }
 MAX-ACCESS read-create
 STATUS current
 DESCRIPTION
 "The type (e.g. internal or exterior) of reachability from the advertising node to the address prefix.

 Reject(2) refers to an address prefix which, if matched, indicates that the message should be discarded as unreachable. This is used in some protocols as a means of correctly aggregating routes."
 REFERENCE
 "ATM Forum PNNI 1.1 Section 5.8.1.3"
 DEFVAL { exterior }
 ::= { pnniRouteAddrEntry 7 }

pnniRouteAddrProto OBJECT-TYPE
 SYNTAX INTEGER {
 other(1), -- not specified
 local(2), -- e.g. ilmi
 mgmt(3), -- configured by management,
 -- for example by SNMP or console
 -- the following are all dynamic
 -- routing protocols
 pnni(4) -- ATM Forum PNNI
 }
 MAX-ACCESS read-only
 STATUS current

DESCRIPTION

"The routing mechanism via which the connectivity from the advertising node to the reachable address prefix was learned."

::= { pnniRouteAddrEntry 8 }

pnniRouteAddrPnniScope OBJECT-TYPE

SYNTAX PnniLevel

MAX-ACCESS read-create

STATUS current

DESCRIPTION

"The PNNI scope of advertisement (i.e. level of PNNI hierarchy) of the reachability from the advertising node to the address prefix."

REFERENCE

"ATM Forum PNNI 1.1 Sections 5.3.6, 5.9.1"

::= { pnniRouteAddrEntry 9 }

pnniRouteAddrVPCapability OBJECT-TYPE

SYNTAX TruthValue

MAX-ACCESS read-create

STATUS current

DESCRIPTION

"Indicates whether VPCs can be established from the advertising node to the reachable address prefix."

REFERENCE

"ATM Forum PNNI 1.1 Section 5.14.9.1 Table 5-34"

::= { pnniRouteAddrEntry 10 }

pnniRouteAddrMetricsTag OBJECT-TYPE

SYNTAX PnniMetricsTag

MAX-ACCESS read-create

STATUS current

DESCRIPTION

"The index into the pnniMetricsTable for the traffic parameter values that apply for the connectivity from the advertising node to the reachable address prefix. There will be one or more entries in the pnniMetricsTable whose first instance identifier matches the value of this variable.

If there are no parameters associated with this reachable address prefix then the distinguished value zero is used."

DEFVAL { 0 }

::= { pnniRouteAddrEntry 11 }

pnniRouteAddrPtseId OBJECT-TYPE

SYNTAX Unsigned32

MAX-ACCESS read-only

STATUS current

DESCRIPTION

"For reachable addresses learned via PNNI, this attribute contains the value of the PTSE Identifier for the PTSE being originated by the originating node which contains the information group(s) describing the reachable address. For reachable addresses learned by means other than PNNI, this attribute is set to zero."

REFERENCE

"ATM Forum PNNI 1.1 Section 5.8.2"

::= { pnniRouteAddrEntry 12 }

pnniRouteAddrOriginateAdvertisement OBJECT-TYPE

SYNTAX TruthValue
 MAX-ACCESS read-create
 STATUS current

DESCRIPTION

"Whether or not the reachable address specified by this entry is to be advertised by the local node into its PNNI routing domain.

This object may only take on the value 'true' when the value of the corresponding instance of pnniRouteAddrProto is other than 'pnni'."

DEFVAL { true }
 ::= { pnniRouteAddrEntry 13 }

pnniRouteAddrInfo OBJECT-TYPE

SYNTAX OBJECT IDENTIFIER
 MAX-ACCESS read-create
 STATUS current

DESCRIPTION

"A reference to MIB definitions specific to the particular routing protocol which is responsible for this reachable address prefix, as determined by the value specified in the route's pnniRouteAddrProto value. If this information is not present, its value should be set to the OBJECT IDENTIFIER zeroDotZero."

DEFVAL { zeroDotZero }
 ::= { pnniRouteAddrEntry 14 }

pnniRouteAddrOperStatus OBJECT-TYPE

SYNTAX INTEGER {
 inactive(1),
 active(2), -- i.e. reachability to this
 -- prefix exists and is not
 -- being advertised in PNNI
 advertised(3)
 }

MAX-ACCESS read-only
 STATUS current

DESCRIPTION

"Indicates whether the reachable address prefix is operationally valid and whether it is being advertised by this node."

::= { pnniRouteAddrEntry 15 }

pnniRouteAddrTimeStamp OBJECT-TYPE

SYNTAX TimeStamp
 MAX-ACCESS read-only
 STATUS current

DESCRIPTION

"Indicates when the connectivity from the advertising node to the reachable address prefix became known to the local node."

::= { pnniRouteAddrEntry 16 }

pnniRouteAddrRowStatus OBJECT-TYPE

SYNTAX RowStatus
 MAX-ACCESS read-create
 STATUS current

DESCRIPTION

```

        "To create, delete, activate and de-activate a reachable
        address prefix."
 ::= { pnniRouteAddrEntry 17 }

-- Table of routes from nodes to reachable transit networks

pnniRouteTnsTable OBJECT-TYPE
    SYNTAX          SEQUENCE OF PnniRouteTnsEntry
    MAX-ACCESS      not-accessible
    STATUS          current
    DESCRIPTION
        "A table containing all the attributes necessary to
        determine what transit networks the PNNI entity believes
        are reachable and to determine which nodes are advertising
        this reachability. This table is also used to add static
        routes to reachable transit networks. The local node index
        which received the reachability information, type of
        network identification, network identification plan,
        transit network identifier, and an index that distinguishes
        between multiple listings of connectivity to a given
        transit network from a given local node are combined to
        form an instance ID for this object."
    REFERENCE
        "ATM Forum PNNI 1.1 Section 5.8.1.3.2"
 ::= { pnniRoutingGroup 5 }

pnniRouteTnsEntry OBJECT-TYPE
    SYNTAX          PnniRouteTnsEntry
    MAX-ACCESS      not-accessible
    STATUS          current
    DESCRIPTION
        "An entry in the table, containing information about a
        reachable transit network."
    REFERENCE
        "ATM Forum PNNI 1.1 Section 5.8.1.3.2"
    INDEX           { pnniNodeIndex,
                    pnniRouteTnsType,
                    pnniRouteTnsPlan,
                    pnniRouteTnsId,
                    pnniRouteTnsIndex }
 ::= { pnniRouteTnsTable 1 }

PnniRouteTnsEntry ::=
    SEQUENCE {
        pnniRouteTnsType          TnsType,
        pnniRouteTnsPlan          TnsPlan,
        pnniRouteTnsId            DisplayString,
        pnniRouteTnsIndex         Integer32,
        pnniRouteTnsIfIndex       InterfaceIndex,
        pnniRouteTnsAdvertisingNodeId PnniNodeId,
        pnniRouteTnsAdvertisedPortId PnniPortId,
        pnniRouteTnsRouteType     INTEGER,
        pnniRouteTnsProto         INTEGER,
        pnniRouteTnsPnniScope     PnniLevel,
        pnniRouteTnsVPCapability  TruthValue,
        pnniRouteTnsMetricsTag     PnniMetricsTag,
        pnniRouteTnsPtseId        Unsigned32,
        pnniRouteTnsOriginateAdvertisement TruthValue,
        pnniRouteTnsInfo          OBJECT IDENTIFIER,
        pnniRouteTnsOperStatus    INTEGER,

```



```

        pnniRouteTnsTimeStamp      TimeStamp,
        pnniRouteTnsRowStatus      RowStatus
    }

```

pnniRouteTnsType OBJECT-TYPE

```

    SYNTAX      TnsType
    MAX-ACCESS  not-accessible
    STATUS      current
    DESCRIPTION
        "The type of network identification used for this transit
        network."
    ::= { pnniRouteTnsEntry 1 }

```

pnniRouteTnsPlan OBJECT-TYPE

```

    SYNTAX      TnsPlan
    MAX-ACCESS  not-accessible
    STATUS      current
    DESCRIPTION
        "The network identification plan according to which network
        identification has been assigned."
    ::= { pnniRouteTnsEntry 2 }

```

pnniRouteTnsId OBJECT-TYPE

```

    SYNTAX      DisplayString
    MAX-ACCESS  not-accessible
    STATUS      current
    DESCRIPTION
        "The value of the transit network identifier."
    ::= { pnniRouteTnsEntry 3 }

```

pnniRouteTnsIndex OBJECT-TYPE

```

    SYNTAX      Integer32 (1..65535)
    MAX-ACCESS  not-accessible
    STATUS      current
    DESCRIPTION
        "An index into the set of listings of connectivity to a
        given transit network from a given local node."
    ::= { pnniRouteTnsEntry 4 }

```

pnniRouteTnsIfIndex OBJECT-TYPE

```

    SYNTAX      InterfaceIndex
    MAX-ACCESS  read-create
    STATUS      current
    DESCRIPTION
        "The local interface over which the transit network can be
        reached. The value zero indicates an unknown interface or
        reachability through a remote node."

```

This object may only have a non-zero value if the value of the corresponding instance of pnniRouteTnsProto is other than 'pnni' and the node identified by pnniRouteTnsAdvertisingNodeId is instantiated within this switching system."

```

    ::= { pnniRouteTnsEntry 5 }

```

pnniRouteTnsAdvertisingNodeId OBJECT-TYPE

```

    SYNTAX      PnniNodeId
    MAX-ACCESS  read-create
    STATUS      current
    DESCRIPTION
        "The node ID of a node advertising reachability to the

```

```

        transit network.  If the local node index is zero, then the
        advertising node ID must also be set to zero."
 ::= { pnniRouteTnsEntry 6 }
pnniRouteTnsAdvertisedPortId OBJECT-TYPE
    SYNTAX      PnniPortId
    MAX-ACCESS  read-create
    STATUS      current
    DESCRIPTION
        "The port identifier used from the advertising node to
        reach the given transit network."
    DEFVAL { 0 }
 ::= { pnniRouteTnsEntry 7 }

pnniRouteTnsRouteType OBJECT-TYPE
    SYNTAX      INTEGER {
                    other(1), -- not specified by this MIB
                    exterior(4)
                }
    MAX-ACCESS  read-create
    STATUS      current
    DESCRIPTION
        "The type (e.g. exterior or other) of reachability from the
        advertising node to the transit network."
    REFERENCE
        "ATM Forum PNNI 1.1 Section 5.8.1.3"
    DEFVAL { exterior }
 ::= { pnniRouteTnsEntry 8 }

pnniRouteTnsProto OBJECT-TYPE
    SYNTAX      INTEGER {
                    other(1), -- not specified
                    local(2), -- e.g. ilmi
                    mgmt(3), -- configured by management,
                    -- for example by SNMP or console
                    -- the following are all dynamic
                    -- routing protocols
                    pnni(4) -- ATM Forum PNNI
                }
    MAX-ACCESS  read-only
    STATUS      current
    DESCRIPTION
        "The routing mechanism via which the connectivity from the
        advertising node to the transit network was learned."
 ::= { pnniRouteTnsEntry 9 }

pnniRouteTnsPnniScope OBJECT-TYPE
    SYNTAX      PnniLevel
    MAX-ACCESS  read-create
    STATUS      current
    DESCRIPTION
        "The PNNI scope of advertisement (i.e. level of PNNI
        hierarchy) of the reachability from the advertising node to
        the transit network."
    REFERENCE
        "ATM Forum PNNI 1.1 Section 5.3.6"
 ::= { pnniRouteTnsEntry 10 }

pnniRouteTnsVPCapability OBJECT-TYPE
    SYNTAX      TruthValue
    MAX-ACCESS  read-create

```

```

STATUS          current
DESCRIPTION
    "Indicates whether VPCs can be established from the
    advertising node to the reachable transit network."
REFERENCE
    "ATM Forum PNNI 1.1 Section 5.14.9.1 Table 5-34"
 ::= { pnniRouteTnsEntry 11 }

pnniRouteTnsMetricsTag OBJECT-TYPE
SYNTAX          PnniMetricsTag
MAX-ACCESS     read-create
STATUS         current
DESCRIPTION
    "The index into the pnniMetricsTable for the traffic
    parameter values that apply for the connectivity from the
    advertising node to the transit network. There will be one
    or more entries in the pnniMetricsTable whose first
    instance identifier matches the value of this variable.

    If there are no parameters associated with this transit
    network then the distinguished value zero is used."
DEFVAL { 0 }
 ::= { pnniRouteTnsEntry 12 }

pnniRouteTnsPtseId OBJECT-TYPE
SYNTAX          Unsigned32
MAX-ACCESS     read-only
STATUS         current
DESCRIPTION
    "For reachable transit networks learned via PNNI, this
    attribute contains the value of the PTSE Identifier for the
    PTSE being originated by the originating node which
    contains the information group(s) describing the transit
    network. For reachable transit networks learned by means
    other than PNNI, this attribute is set to zero."
REFERENCE
    "ATM Forum PNNI 1.1 Section 5.8.2"
 ::= { pnniRouteTnsEntry 13 }

pnniRouteTnsOriginateAdvertisement OBJECT-TYPE
SYNTAX          TruthValue
MAX-ACCESS     read-create
STATUS         current
DESCRIPTION
    "Whether or not the transit network specified by this entry
    is to be advertised by the local node into its PNNI routing
    domain.

    This object may only take on the value 'true' when the
    value of the corresponding instance of pnniRouteNodeProto
    is other than 'pnni'."
DEFVAL { true }
 ::= { pnniRouteTnsEntry 14 }

pnniRouteTnsInfo OBJECT-TYPE
SYNTAX          OBJECT IDENTIFIER
MAX-ACCESS     read-create
STATUS         current
DESCRIPTION
    "A reference to MIB definitions specific to the particular
    routing protocol which is responsible for this transit

```

```

        network, as determined by the value specified in the
        route's pnniRouteTnsProto value.  If this information is
        not present, its value should be set to the OBJECT
        IDENTIFIER zeroDotZero."
DEFVAL { zeroDotZero }
 ::= { pnniRouteTnsEntry 15 }

pnniRouteTnsOperStatus OBJECT-TYPE
    SYNTAX          INTEGER {
                        inactive(1),
                        active(2), -- i.e. reachability to this
                        -- transit network exists and is
                        -- not being advertised in PNNI
                        advertised(3)
                    }
    MAX-ACCESS      read-only
    STATUS          current
    DESCRIPTION
        "Indicates whether the reachable transit network is
        operationally valid and whether it is being advertised by
        this node."
    ::= { pnniRouteTnsEntry 16 }

pnniRouteTnsTimeStamp OBJECT-TYPE
    SYNTAX          TimeStamp
    MAX-ACCESS      read-only
    STATUS          current
    DESCRIPTION
        "Indicates how long the connectivity from the advertising
        node to the reachable transit network has been known to the
        local node."
    ::= { pnniRouteTnsEntry 17 }

pnniRouteTnsRowStatus OBJECT-TYPE
    SYNTAX          RowStatus
    MAX-ACCESS      read-create
    STATUS          current
    DESCRIPTION
        "To create, delete, activate and de-activate a reachable
        transit network."
    ::= { pnniRouteTnsEntry 18 }

-- conformance information

pnniMIBConformance
pnniMIBCompliances
pnniMIBGroups
    OBJECT IDENTIFIER ::= { pnniMIB 2 }
    OBJECT IDENTIFIER ::= { pnniMIBConformance 1 }
    OBJECT IDENTIFIER ::= { pnniMIBConformance 2 }

-- compliance statements

pnniMIBCompliance MODULE-COMPLIANCE
    STATUS          current
    DESCRIPTION
        "The compliance statement for entities which implement
        the PNNI MIB."

```

Groups of PNNI objects required for management of a minimum function node are identified by the suffix MinGroup.

Groups of PNNI objects required for management of a border node are identified by the suffix BorderGroup.

Groups of PNNI objects required for management of a PGL/LGN capable node are identified by the suffix LgnGroup.

Groups of optional PNNI objects are identified by the suffix OptionalGroup."

```

MODULE -- this module
  MANDATORY-GROUPS {
    pnniGeneralMinGroup,
    pnniNodeMinGroup,
    pnniNodePglMinGroup,
    pnniNodeTimerMinGroup,
    pnniScopeMinGroup,
    pnniIfMinGroup,
    pnniLinkMinGroup,
    pnniNbrPeerMinGroup,
    pnniNbrPeerPortMinGroup }

OBJECT pnniNodeId
MIN-ACCESS read-only
DESCRIPTION
  "Support for manual configuration of node IDs is optional."

OBJECT pnniNodeLowest
MIN-ACCESS read-only
DESCRIPTION
  "Only switching systems that are PGL/LGN capable are allowed
  to provide write/create access to the pnniNodeLowest
  object."

OBJECT pnniNodeRestrictedTransit
MIN-ACCESS read-only
DESCRIPTION
  "Support for the restricted transit capability is optional."

OBJECT pnniNodeComplexRep
MIN-ACCESS read-only
DESCRIPTION
  "The ability to generate the complex node representation is
  only required for PGL/LGN capable switching systems, and is
  otherwise optional."

OBJECT pnniNodeRowStatus
SYNTAX INTEGER { active(1) }
MIN-ACCESS read-only
DESCRIPTION
  "The ability to create more than one node in a switching
  system is optional."

OBJECT pnniNodePglLeadershipPriority
MIN-ACCESS read-only
DESCRIPTION
  "Only switching systems that are PGL/LGN capable are allowed
  to provide write/create access to the
  pnniNodePglLeadershipPriority object."

OBJECT pnniIfNodeIndex
MIN-ACCESS read-only

```

```

DESCRIPTION
    "Write access to the pnniIfNodeIndex object is optional. It
    only applies when there can be multiple lowest-level nodes
    in the switching system."

OBJECT pnniIfVPCapability
MIN-ACCESS read-only
DESCRIPTION
    "The ability to support switched virtual paths is optional."

 ::= { pnniMIBCompliances 1 }

-- units of conformance

pnniGeneralMinGroup OBJECT-GROUP
    OBJECTS {
        pnniHighestVersion,
        pnniLowestVersion,
        pnniDtlCountOriginator,
        pnniCrankbackCountOriginator,
        pnniAltRouteCountOriginator,
        pnniRouteFailCountOriginator,
        pnniRouteFailUnreachableOriginator
    }
    STATUS current
    DESCRIPTION
        "A collection of general PNNI objects required for
        management of a minimum function switching system."
    ::= { pnniMIBGroups 1 }

pnniGeneralBorderGroup OBJECT-GROUP
    OBJECTS {
        pnniDtlCountBorder,
        pnniCrankbackCountBorder,
        pnniAltRouteCountBorder,
        pnniRouteFailCountBorder,
        pnniRouteFailUnreachableBorder
    }
    STATUS current
    DESCRIPTION
        "A collection of general PNNI objects required for
        management of a border node."
    ::= { pnniMIBGroups 2 }

pnniNodeMinGroup OBJECT-GROUP
    OBJECTS {
        pnniNodeLevel,
        pnniNodeId,
        pnniNodeLowest,
        pnniNodeAdminStatus,
        pnniNodeOperStatus,
        pnniNodeDomainName,
        pnniNodeAtmAddress,
        pnniNodePeerGroupId,
        pnniNodeRestrictedTransit,
        pnniNodeComplexRep,
        pnniNodeRestrictedBranching,
        pnniNodeDatabaseOverload,
        pnniNodePtses,
        pnniNodeRowStatus
    }

```

```
STATUS current
DESCRIPTION
  "A collection of per node PNNI objects required for
  management of a minimum function switching system."
 ::= { pnniMIBGroups 3 }

pnniNodePglMinGroup OBJECT-GROUP
OBJECTS {
    pnniNodePglLeadershipPriority,
    pnniNodePglInitTime,
    pnniNodePglReelectTime ,
    pnniNodePglState,
    pnniNodePreferredPgl,
    pnniNodePeerGroupLeader,
    pnniNodePglTimeStamp,
    pnniNodeActiveParentNodeId
}

STATUS current
DESCRIPTION
  "A collection of per node PGL election related PNNI objects
  required for management of a minimum function switching
  system."
 ::= { pnniMIBGroups 4 }

pnniNodePglLgnGroup OBJECT-GROUP
OBJECTS {
    pnniNodeCfgParentNodeIndex,
    pnniNodePglOverrideDelay
}

STATUS current
DESCRIPTION
  "A collection of per node PGL election related PNNI objects
  required for management of a PGL/LGN capable switching
  system."
 ::= { pnniMIBGroups 5 }

pnniNodeTimerMinGroup OBJECT-GROUP
OBJECTS {
    pnniNodePtseHolddown,
    pnniNodeHelloHolddown,
    pnniNodeHelloInterval,
    pnniNodeHelloInactivityFactor,
    pnniNodePtseRefreshInterval,
    pnniNodePtseLifetimeFactor,
    pnniNodeRxmtInterval,
    pnniNodePeerDelayedAckInterval,
    pnniNodeAvcrPm,
    pnniNodeAvcrMt,
    pnniNodeCdvPm,
    pnniNodeCtdPm
}

STATUS current
DESCRIPTION
  "A collection of per node PNNI objects required for
  management of timers and significant change thresholds in a
  minimum function switching system."
 ::= { pnniMIBGroups 6 }

pnniNodeTimerLgnGroup OBJECT-GROUP
OBJECTS {
    pnniNodeHlinkInact
```

```
    }
    STATUS current
    DESCRIPTION
        "A collection of per node PNNI objects required for
        management of timers in a PGL/LGN capable switching
        system."
    ::= { pnniMIBGroups 7 }

pnniNodeSvccLgnGroup OBJECT-GROUP
    OBJECTS {
        pnniNodeSvccInitTime,
        pnniNodeSvccRetryTime,
        pnniNodeSvccCallingIntegrityTime,
        pnniNodeSvccCalledIntegrityTime,
        pnniNodeSvccTrafficDescriptorIndex
    }
    STATUS current
    DESCRIPTION
        "A collection of per node SVCC-based RCC related PNNI
        objects required for management of a PGL/LGN capable
        switching system."
    ::= { pnniMIBGroups 8 }

pnniScopeMinGroup OBJECT-GROUP
    OBJECTS {
        pnniScopeLocalNetwork,
        pnniScopeLocalNetworkPlusOne,
        pnniScopeLocalNetworkPlusTwo,
        pnniScopeSiteMinusOne,
        pnniScopeIntraSite,
        pnniScopeSitePlusOne,
        pnniScopeOrganizationMinusOne,
        pnniScopeIntraOrganization,
        pnniScopeOrganizationPlusOne,
        pnniScopeCommunityMinusOne,
        pnniScopeIntraCommunity,
        pnniScopeCommunityPlusOne,
        pnniScopeRegional,
        pnniScopeInterRegional,
        pnniScopeGlobal
    }
    STATUS current
    DESCRIPTION
        "A collection of per node scope mapping related PNNI objects
        required for management of a minimum function switching
        system."
    ::= { pnniMIBGroups 9 }

pnniSummaryLgnGroup OBJECT-GROUP
    OBJECTS {
        pnniSummaryType,
        pnniSummarySuppress,
        pnniSummaryState,
        pnniSummaryRowStatus
    }
    STATUS deprecated
    DESCRIPTION
        "A collection of PNNI objects required for controlling
        address summarization."
    ::= { pnniMIBGroups 10 }
```



```
pnniSummaryAddressLgnGroup OBJECT-GROUP
  OBJECTS {
    pnniSummaryAddressSuppress,
    pnniSummaryAddressState,
    pnniSummaryAddressRowStatus
  }
  STATUS current
  DESCRIPTION
    "A collection of PNNI objects required for controlling address
    summarization."
  ::= { pnniMIBGroups 31 }
```

```
pnniIfMinGroup OBJECT-GROUP
  OBJECTS {
    pnniIfNodeIndex,
    pnniIfPortId,
    pnniIfVPCapability,
    pnniIfAdmWeightCbr,
    pnniIfAdmWeightRtVbr,
    pnniIfAdmWeightNrtVbr,
    pnniIfAdmWeightAbr,
    pnniIfAdmWeightUbr,
    pnniIfRccServiceCategory,
    pnniIfRccTrafficDescrIndex
  }
  STATUS current
  DESCRIPTION
    "A collection of per interface PNNI objects required for
    management of a minimum function switching system."
  ::= { pnniMIBGroups 11 }
```

```
pnniIfBorderGroup OBJECT-GROUP
  OBJECTS {
    pnniIfAggrToken
  }
  STATUS current
  DESCRIPTION
    "A collection of per interface PNNI objects required for
    management of a border node."
  ::= { pnniMIBGroups 12 }
```

```
pnniLinkMinGroup OBJECT-GROUP
  OBJECTS {
    pnniLinkType,
    pnniLinkVersion,
    pnniLinkHelloState,
    pnniLinkRemoteNodeId,
    pnniLinkRemotePortId,
    pnniLinkIfIndex,
    pnniLinkRcvHellos,
    pnniLinkXmtHellos
  }
  STATUS current
  DESCRIPTION
    "A collection of per link PNNI objects required for
    management of a minimum function switching system."
  ::= { pnniMIBGroups 13 }
```

```
pnniLinkBorderOrLgnGroup OBJECT-GROUP
  OBJECTS {
```

```

        pnniLinkDerivedAggrToken,
        pnniLinkUpnodeId,
        pnniLinkUpnodeAtmAddress,
        pnniLinkCommonPeerGroupId
    }
STATUS current
DESCRIPTION
    "A collection of per link PNNI objects required for
    management of a border node or a PGL/LGN capable switching
    system."
 ::= { pnniMIBGroups 14 }

pnniLinkLgnGroup OBJECT-GROUP
OBJECTS {
    pnniLinkSvccRccIndex
}
STATUS current
DESCRIPTION
    "A collection of per link PNNI objects required for
    management of a PGL/LGN capable switching system."
 ::= { pnniMIBGroups 15 }

pnniNbrPeerMinGroup OBJECT-GROUP
OBJECTS {
    pnniNbrPeerState,
    pnniNbrPeerPortCount,
    pnniNbrPeerRcvDbSums,
    pnniNbrPeerXmtDbSums,
    pnniNbrPeerRcvPtsp,
    pnniNbrPeerXmtPtsp,
    pnniNbrPeerRcvPtseReqs,
    pnniNbrPeerXmtPtseReqs,
    pnniNbrPeerRcvPtseAcks,
    pnniNbrPeerXmtPtseAcks
}
STATUS current
DESCRIPTION
    "A collection of per neighboring peer PNNI objects required
    for management of a minimum function switching system."
 ::= { pnniMIBGroups 16 }

pnniNbrPeerLgnGroup OBJECT-GROUP
OBJECTS {
    pnniNbrPeerSvccRccIndex
}
STATUS current
DESCRIPTION
    "A collection of per neighboring peer PNNI objects required
    for management of a PGL/LGN capable switching system."
 ::= { pnniMIBGroups 17 }

pnniNbrPeerPortMinGroup OBJECT-GROUP
OBJECTS {
    pnniNbrPeerPortFloodStatus
}
STATUS current
DESCRIPTION
    "A collection of per port to neighboring peer PNNI objects
    required for management of a minimum function switching
    system."
 ::= { pnniMIBGroups 18 }

```

```

pnniSvccRccLgnGroup OBJECT-GROUP
  OBJECTS {
    pnniSvccRccVersion,
    pnniSvccRccHelloState,
    pnniSvccRccRemoteNodeId ,
    pnniSvccRccRemoteAtmAddress,
    pnniSvccRccRcvHellos,
    pnniSvccRccXmtHellos,
    pnniSvccRccIfIndex,
    pnniSvccRccVpi,
    pnniSvccRccVci
  }
  STATUS current
  DESCRIPTION
    "A collection of per SVCC-based RCC PNNI objects required
    for management of a PGL/LGN capable switching system."
  ::= { pnniMIBGroups 19 }

pnniPtseOptionalGroup OBJECT-GROUP
  OBJECTS {
    pnniPtseType,
    pnniPtseSequenceNum,
    pnniPtseChecksum,
    pnniPtseLifeTime,
    pnniPtseInfo
  }
  STATUS current
  DESCRIPTION
    "A collection of optional per PTSE PNNI objects."
  ::= { pnniMIBGroups 20 }

pnniMapOptionalGroup OBJECT-GROUP
  OBJECTS {
    pnniMapType,
    pnniMapPeerGroupId,
    pnniMapAggrToken,
    pnniMapRemoteNodeId,
    pnniMapRemotePortId,
    pnniMapVPCapability,
    pnniMapPtseId,
    pnniMapMetricsTag
  }
  STATUS current
  DESCRIPTION
    "A collection of optional PNNI objects used to create a map
    of nodes and links in the PNNI routing domain."
  ::= { pnniMIBGroups 21 }

pnniMapNodeOptionalGroup OBJECT-GROUP
  OBJECTS {
    pnniMapNodePeerGroupId,
    pnniMapNodeAtmAddress,
    pnniMapNodeRestrictedTransit,
    pnniMapNodeComplexRep,
    pnniMapNodeRestrictedBranching,
    pnniMapNodeDatabaseOverload,
    pnniMapNodeIAmLeader,
    pnniMapNodeLeadershipPriority,
    pnniMapNodePreferredPgl,

```

```
        pnniMapNodeParentNodeId,
        pnniMapNodeParentAtmAddress,
        pnniMapNodeParentPeerGroupId,
        pnniMapNodeParentPglNodeId
    }
STATUS current
DESCRIPTION
    "A collection of optional PNNI objects used to create a map
    of nodes in the PNNI routing domain."
 ::= { pnniMIBGroups 22 }

pnniMapAddrOptionalGroup OBJECT-GROUP
OBJECTS {
    pnniMapAddrAddress,
    pnniMapAddrPrefixLength
}
STATUS current
DESCRIPTION
    "A collection of optional PNNI objects used to create a map
    of reachable addresses in the PNNI routing domain."
 ::= { pnniMIBGroups 23 }

pnniMapTnsOptionalGroup OBJECT-GROUP
OBJECTS {
    pnniMapTnsId
}
STATUS current
DESCRIPTION
    "A collection of optional PNNI objects used to create a map
    of reachable transit networks in the PNNI routing domain."
 ::= { pnniMIBGroups 24 }

pnniMetricsOptionalGroup OBJECT-GROUP
OBJECTS {
    pnniMetricsClasses,
    pnniMetricsGcacClp,
    pnniMetricsAdminWeight,
    pnniMetrics1,
    pnniMetrics2,
    pnniMetrics3,
    pnniMetrics4,
    pnniMetrics5,
    pnniMetrics6,
    pnniMetrics7,
    pnniMetrics8,
    pnniMetricsRowStatus
}
STATUS current
DESCRIPTION
    "A collection of optional PNNI objects used to manage
    metrics and attributes associated with PNNI entities."
 ::= { pnniMIBGroups 25 }

pnniRouteGeneralOptionalGroup OBJECT-GROUP
OBJECTS {
    pnniRouteNodeNumber,
    pnniRouteAddrNumber
}
STATUS current
DESCRIPTION
    "A collection of optional PNNI objects."
```

```
::= { pnniMIBGroups 26 }
```

```
pnniRouteNodeOptionalGroup OBJECT-GROUP
  OBJECTS {
```

```
    pnniRouteNodeDestPortId,
    pnniRouteNodeProto,
    pnniRouteNodeTimeStamp,
    pnniRouteNodeInfo,
    pnniRouteNodeGcacClp,
    pnniRouteNodeFwdMetricAW,
    pnniRouteNodeFwdMetric1,
    pnniRouteNodeFwdMetric2,
    pnniRouteNodeFwdMetric3,
    pnniRouteNodeFwdMetric4,
    pnniRouteNodeFwdMetric5,
    pnniRouteNodeFwdMetric6,
    pnniRouteNodeFwdMetric7,
    pnniRouteNodeFwdMetric8,
    pnniRouteNodeBwdMetricAW,
    pnniRouteNodeBwdMetric1,
    pnniRouteNodeBwdMetric2,
    pnniRouteNodeBwdMetric3,
    pnniRouteNodeBwdMetric4,
    pnniRouteNodeBwdMetric5,
    pnniRouteNodeBwdMetric6,
    pnniRouteNodeBwdMetric7,
    pnniRouteNodeBwdMetric8,
    pnniRouteNodeVPCapability,
    pnniRouteNodeStatus
  }
```

```
STATUS current
```

```
DESCRIPTION
```

```
"A collection of optional PNNI objects used to manage
  precalculated routes to nodes in the PNNI routing domain."
```

```
::= { pnniMIBGroups 27 }
```

```
pnniDTLOptionalGroup OBJECT-GROUP
  OBJECTS {
```

```
    pnniDTLNodeId,
    pnniDTLPortId,
    pnniDTLLinkType,
    pnniDTLStatus
  }
```

```
STATUS current
```

```
DESCRIPTION
```

```
"A collection of optional PNNI objects used to manage
  precalculated routes to nodes in the PNNI routing domain."
```

```
::= { pnniMIBGroups 28 }
```

```
pnniRouteAddrOptionalGroup OBJECT-GROUP
  OBJECTS {
```

```
    pnniRouteAddrIfIndex,
    pnniRouteAddrAdvertisingNodeId,
    pnniRouteAddrAdvertisedPortId,
    pnniRouteAddrType,
    pnniRouteAddrProto,
    pnniRouteAddrPnniScope,
    pnniRouteAddrVPCapability,
    pnniRouteAddrMetricsTag,
    pnniRouteAddrPtseId,
    pnniRouteAddrOriginateAdvertisement,
```

```

        pnniRouteAddrInfo,
        pnniRouteAddrOperStatus,
        pnniRouteAddrTimeStamp,
        pnniRouteAddrRowStatus
    }
STATUS current
DESCRIPTION
    "A collection of optional PNNI objects used to manage routes
    to reachable addresses in the PNNI routing domain."
 ::= { pnniMIBGroups 29 }

pnniRouteTnsOptionalGroup OBJECT-GROUP
    OBJECTS {
        pnniRouteTnsIfIndex,
        pnniRouteTnsAdvertisingNodeId,
        pnniRouteTnsAdvertisedPortId,
        pnniRouteTnsRouteType,
        pnniRouteTnsProto,
        pnniRouteTnsPnniScope,
        pnniRouteTnsVPCapability,
        pnniRouteTnsMetricsTag,
        pnniRouteTnsPtseId,
        pnniRouteTnsOriginateAdvertisement,
        pnniRouteTnsInfo,
        pnniRouteTnsOperStatus,
        pnniRouteTnsTimeStamp,
        pnniRouteTnsRowStatus
    }
STATUS current
DESCRIPTION
    "A collection of optional PNNI objects used to manage routes
    to reachable transit networks in the PNNI routing domain."
 ::= { pnniMIBGroups 30 }

pnniNodeGssOptionalGroup OBJECT-GROUP
    OBJECTS {
        pnniNodeCoBiTransportSupported,
        pnniNodeClBiTransportSupported
    }
STATUS current
DESCRIPTION
    "A collection of optional per-node PNNI objects used for
    management of generic support for supplementary services."
 ::= { pnniMIBGroups 32 }

pnniUbrWithMdcOptionalGroup OBJECT-GROUP
    OBJECTS {
        pnniNodeBeCRT,
        pnniNodeGenerateUbrAvCR,
        pnniNodeGenerateBeCR,
        pnniNodeBeCRTuningFactor,
        pnniMetricsAvcrIndicatorForUbr,
        pnniMetrics9
    }
STATUS current
DESCRIPTION
    "A collection of optional PNNI objects used for
    management of the UBR with MDCR capability."
 ::= { pnniMIBGroups 33 }

pnniGfrOptionalGroup OBJECT-GROUP

```

```
OBJECTS {
    pnniIfAdmWeightGfr,
    pnniMetricsGfrCapability,
    pnniMetrics10,
    pnniRouteNodeGfrCapability,
    pnniNodeAccBctPm}
STATUS current
DESCRIPTION
    "A collection of optional PNNI objects used for the management
    of the GFR ATM Service Category."
 ::= { pnniMIBGroups 34 }

pnniVersionOneDotOneOptionalGroup OBJECT-GROUP
OBJECTS {
    pnniNodeEmbedAddrAESAPrefixAdvType,
    pnniNodeMinTimeToFlush,
    pnniNodeMaxTimeToFlush
}
STATUS current
DESCRIPTION
    "A collection of optional PNNI objects used for the
    management of new and revised capabilities in PNNI
    version 1.1."
 ::= { pnniMIBGroups 35 }

END
```

14.2 The Updated Soft PVC Management Information Base (as in af-pnni-0055.002.mibsoft)

```

ATM-SOFT-PVC-MIB DEFINITIONS ::= BEGIN

IMPORTS
    enterprises                               FROM RFC1155-SMI
    MODULE-IDENTITY, OBJECT-TYPE,
    NOTIFICATION-TYPE,
    Counter32, Gauge32, Integer32           FROM SNMPv2-SMI
    TEXTUAL-CONVENTION, RowStatus,
    TruthValue, TimeStamp                   FROM SNMPv2-TC
    MODULE-COMPLIANCE, OBJECT-GROUP,
    NOTIFICATION-GROUP                     FROM SNMPv2-CONF
    ifIndex                                  FROM IF-MIB
    atmVplVpi, atmVclVpi,
    atmVclVci                                FROM ATM-MIB;

atmSoftPvcMIB MODULE-IDENTITY
    LAST-UPDATED      "200202110000Z"
    ORGANIZATION      "The ATM Forum."
    CONTACT-INFO
        "The ATM Forum
        Presidio of San Francisco
        P.O. Box 29920
        527B Ruger Street
        San Francisco, CA 94129-0920 USA
        Phone: +1 415-561-6275
        Fax: +1 415-561-6120
        info@atmforum.com"
    DESCRIPTION
        "ATM Soft PVC MIB"
    REVISION          "200202110000Z"
    DESCRIPTION
        "Updated version of the Soft PVC MIB released with the
        PNNI 1.1 specification (af-pnni-0055.002)."
```

```

    REVISION          "9905210000Z"
    DESCRIPTION
        "Updated version of the Soft PVC MIB released with the
        PNNI SPVC Addendum version 1.0 (af-cs-0127.000)."
```

```

    REVISION          "9705010000Z"
    DESCRIPTION
        "Updated version of the Soft PVC MIB released with the
        PNNI V1.0 Errata and PICS (af-pnni-0081.000)."
```

```

    REVISION          "9606210000Z"
    DESCRIPTION
        "Initial version of this MIB module."
    ::= { atmSoftPvc 1 }

atmForum          OBJECT IDENTIFIER ::= { enterprises 353 }
atmForumNetworkManagement OBJECT IDENTIFIER ::= { atmForum 5 }
atmSoftPvc        OBJECT IDENTIFIER ::= { atmForumNetworkManagement 5 }

atmSoftPvcMIBObjects OBJECT IDENTIFIER ::= { atmSoftPvcMIB 1 }
atmSoftPvcMIBTraps   OBJECT IDENTIFIER ::= { atmSoftPvcMIB 2 }

AtmAddr ::= TEXTUAL-CONVENTION
    STATUS current
    DESCRIPTION
        "The ATM address used by the network entity.
        The address types are: no address (0 octets),
```



```

                E.164 (8 octets)and NSAP (20 octets).
                Note: The E.164 address is encoded in BCD format."
SYNTAX      OCTET STRING (SIZE(0|8|20))
--
-- This MIB contains five tables and a number of scalars. The scalars
-- contain overall status information and counters. The tables are:
--   Soft PVC VCCs - manage Soft PVCC at originating switch
--   Soft PVC VPCs - manage Soft PVPC at originating switch
--   Interface Soft PVC Address
--   Currently failing Soft PVCC table
--   Currently failing Soft PVPC table
--
-- Traffic statistics for Soft PVCCs and Soft PVPCs are accessible
-- via the atmVclStatTable and atmVplStatTable, as defined in the
-- Supplemental AtomMIB
--

atmSoftPvcBaseGroup      OBJECT IDENTIFIER ::= { atmSoftPvcMIBObjects 1}

atmSoftPvcCallFailuresTrapEnable      OBJECT-TYPE
    SYNTAX      TruthValue
    MAX-ACCESS      read-write
    STATUS      current
    DESCRIPTION
        "Allows the generation of traps in response to call
        failures. By default, this object is set to 'false'."
    ::= { atmSoftPvcBaseGroup 1 }

atmSoftPvcCallFailures      OBJECT-TYPE
    SYNTAX      Counter32
    MAX-ACCESS      read-only
    STATUS      current
    DESCRIPTION
        "The number of times a series of call attempts has failed to
        establish a Soft PVCC or Soft PVPC. The number of call
        attempts in a series is determined by
        atmSoftPVccRetryThreshold or atmSoftPVpcRetryThreshold,
        respectively."
    ::= { atmSoftPvcBaseGroup 2 }

atmSoftPvcCurrentlyFailingSoftPVccs      OBJECT-TYPE
    SYNTAX      Gauge32
    MAX-ACCESS      read-only
    STATUS      current
    DESCRIPTION
        "The current number of Soft PVCCs for which there is
        an active row in the atmSoftPVccTable having an
        atmSoftPVccOperStatus with a value other than 'connected'."
    ::= { atmSoftPvcBaseGroup 3 }

atmSoftPvcCurrentlyFailingSoftPVpcs      OBJECT-TYPE
    SYNTAX      Gauge32
    MAX-ACCESS      read-only
    STATUS      current
    DESCRIPTION
        "The current number of Soft PVPCs for which there is an
        active row in the atmSoftPVpcTable having an

```

```

        atmSoftPVpcOperStatus with a value other than 'connected'."
 ::= { atmSoftPvcBaseGroup 4 }

```

```

atmSoftPvcNotificationInterval OBJECT-TYPE
    SYNTAX  INTEGER (0..3600)
    UNITS   "seconds"
    MAX-ACCESS  read-write
    STATUS   current
    DESCRIPTION
        "The minimum interval between the sending
         of atmSoftPvcCallFailuresTrap notifications."
    DEFVAL { 30 }
    ::= { atmSoftPvcBaseGroup 5 }

```

```

--
-- Table to manage Soft PVCCs.
--

```

```

atmSoftPVccTable          OBJECT-TYPE
    SYNTAX  SEQUENCE OF AtmSoftPVccEntry
    MAX-ACCESS  not-accessible
    STATUS   current
    DESCRIPTION
        "The (conceptual) table used to manage Soft
         Permanent Virtual Channel Connections (Soft PVCCs).
         The Soft PVCC table is applicable only to switches."
    ::= { atmSoftPvcMIBObjects 2 }

```

```

atmSoftPVccEntry          OBJECT-TYPE
    SYNTAX  AtmSoftPVccEntry
    MAX-ACCESS  not-accessible
    STATUS   current
    DESCRIPTION
        "Each entry in this table represents a Soft
         Permanent Virtual Channel Connection (Soft PVCC)
         originating at a switch interface.

        A Soft PVCC is a VCC that is:
        - provisioned at the originating (source)
          interface of the connection
        - established by signalling procedures
          across a network to a destination interface.

```

A row in the atmVclTable must be created, defining a VCL on the source interface, prior to creating an atmSoftPVccEntry row. The row in the atmVclTable must be active prior to activating the atmSoftPVccEntry row.

The contents of this table reflect only the characteristics unique to a Soft PVCC. The traffic parameters are defined in the VCL row for the source interface, as specified in the ATOMMIB (RFC2515) and the forthcoming addition, the Supplemental ATOMMIB.

When a row is made active, an attempt is made to set up a switched connection to an interface at the destination switch. No objects (other than

atmSoftPVccRowStatus) can be set while the row is active.

At the destination, the VCL may be defined (but not cross-connected) prior to arrival of the Setup request.

The combination of ifIndex, atmVclVpi, and atmVclVci specified in the index clause of this entry serves to identify the VCL on the source interface. The atmSoftPVccLeafReference object aids in distinguishing between leaves of a point-to-multipoint Soft PVCC."

```
INDEX { ifIndex,
        atmVclVpi,
        atmVclVci,
        atmSoftPVccLeafReference }
 ::= { atmSoftPVccTable 1 }
```

```
AtmSoftPVccEntry ::=
SEQUENCE {
    atmSoftPVccLeafReference          INTEGER,
    atmSoftPVccTargetAddress          AtmAddr,
    atmSoftPVccTargetSelectType      INTEGER,
    atmSoftPVccTargetVpi             INTEGER,
    atmSoftPVccTargetVci             INTEGER,
    atmSoftPVccLastReleaseCause      INTEGER,
    atmSoftPVccLastReleaseDiagnostic OCTET STRING,
    atmSoftPVccOperStatus            INTEGER,
    atmSoftPVccRestart               INTEGER,
    atmSoftPVccRetryInterval         INTEGER,
    atmSoftPVccRetryTimer            INTEGER,
    atmSoftPVccRetryThreshold        INTEGER,
    atmSoftPVccRetryFailures         Gauge32,
    atmSoftPVccRetryLimit            INTEGER,
    atmSoftPVccRowStatus             RowStatus,
    atmSoftPVccTargetDlci            Integer32,
    atmSoftPVccTargetType            INTEGER,
    atmSoftPVccTargetVpci           INTEGER
}
```

```
atmSoftPVccLeafReference OBJECT-TYPE
SYNTAX  INTEGER (1..65535)
MAX-ACCESS not-accessible
STATUS  current
DESCRIPTION
    "An arbitrary integer which, in the case of the
    source VCL having an atmVclCastType of
    'p2mpRoot', serves to distinguish between the
    multiple leaves attached to a root of a
    point-to-multipoint Soft PVCC. If the atmVclCastType
    is not 'p2mpRoot' the value 1 shall be used."
 ::= { atmSoftPVccEntry 1 }
```

```
atmSoftPVccTargetAddress OBJECT-TYPE
SYNTAX  AtmAddr
MAX-ACCESS read-create
STATUS  current
DESCRIPTION
```

```

                "The target ATM Address of this Soft PVCC.  If no
                address is supplied, no attempts to establish the
                Soft PVCC are initiated."
 ::= { atmSoftPVccEntry 2 }

```

```

atmSoftPVccTargetSelectType    OBJECT-TYPE
    SYNTAX  INTEGER {
                                required(1),
                                any(2)
                            }
    MAX-ACCESS      read-create
    STATUS          current
    DESCRIPTION
        "Indicates whether the target VPCI/VCI values
        are to be used at the destination.

        If the value 'any' is specified, the destination
        switch will choose the VPCI/VCI values.  In such a
        case, once the Soft PVCC atmSoftPVccOperStatus
        value is 'connected', the value of this object
        changes to 'required', such that the same VPCI/VCI
        values will continue to be used even if the connection
        is subsequently torn down and re-established.  The
        VPCI/VCI values chosen will be available for reading in
        atmSoftPVccTargetVpci and atmSoftPVccTargetVci.

        If the value 'required' is specified, then values
        must be supplied for objects atmSoftPVccTargetVpci
        and atmSoftPVccTargetVci prior to activation of the
        row.  These values are then to be used at the destination."
    DEFVAL { required }
 ::= { atmSoftPVccEntry 3 }

```

```

atmSoftPVccTargetVpi          OBJECT-TYPE
    SYNTAX  INTEGER (0..4095)
    MAX-ACCESS      read-create
    STATUS          deprecated
    DESCRIPTION
        "The VPI value of the VCL used at the target interface.
        This value is not relevant when the value of
        atmSoftPVccTargetSelectType is 'any'.

        This object is replaced by the new object
        atmSoftPVccTargetVpci."
    DEFVAL { 0 }
 ::= { atmSoftPVccEntry 4 }

```

```

atmSoftPVccTargetVci          OBJECT-TYPE
    SYNTAX  INTEGER (0..65535)
    MAX-ACCESS      read-create
    STATUS          current
    DESCRIPTION
        "The VCI value of the VCL used at the target interface.
        This value must be filled in when the
        atmSoftPVccTargetSelectType is set to 'required'.This
        value is not relevant when the value of
        atmSoftPVccTargetSelectType is 'any'."
 ::= { atmSoftPVccEntry 5 }

```

```

atmSoftPVccLastReleaseCause      OBJECT-TYPE
    SYNTAX  INTEGER(1..127)
    MAX-ACCESS      read-only
    STATUS      current
    DESCRIPTION
        "Value of the Cause field of the Cause
        Information Element in the last RELEASE
        signalling message received for this Soft PVCC.
        Indicates the reason for the Release."
    ::= { atmSoftPVccEntry 6 }

atmSoftPVccLastReleaseDiagnostic  OBJECT-TYPE
    SYNTAX  OCTET STRING (SIZE(0..8))
    MAX-ACCESS      read-only
    STATUS      current
    DESCRIPTION
        "Value of the first 8 bytes of diagnostic information
        from the Cause field of the Cause Information Element
        in the last RELEASE signalling message received for
        this Soft PVCC."
    ::= { atmSoftPVccEntry 7 }

atmSoftPVccOperStatus            OBJECT-TYPE
    SYNTAX  INTEGER {
        other(1),
        establishmentInProgress(2),
        connected(3),
        retriesExhausted(4),
        noAddressSupplied(5),
        lowerLayerDown(6)
    }
    MAX-ACCESS      read-only
    STATUS      current
    DESCRIPTION
        "Describes the status of the Soft PVCC.  Valid values
        are:
        other          - none of the types specified below
        establishmentInProgress - connection or party is not
            operational, but setup or add
            party attempts are ongoing
        connected      - connection or party is currently
            operational
        retriesExhausted - retry limit has been reached and
            setup or add party attempts have
            ceased
        noAddressSupplied - no remote address has been
            configured, so no setup or add
            party attempts are initiated
        lowerLayerDown - underlying ATM interface is not
            operational
        When the row is not 'active', the value of this
        object is 'other'."
    ::= { atmSoftPVccEntry 8 }

atmSoftPVccRestart              OBJECT-TYPE
    SYNTAX  INTEGER {

```

```

                restart(1),
                noop(2)
            }
MAX-ACCESS      read-create
STATUS          current
DESCRIPTION
    "When the value is set to 'restart' the Soft PVCC
    is released if necessary and a new setup procedure
    is begun. As a result of this action, the
    atmSoftPVccOperStatus object transitions to
    'establishmentInProgress' (if not already in this state)
    and the atmSoftPVccRetryFailures object is cleared

    When the value is set to 'noop' no operation is
    performed. When read, the value 'noop' is returned."
 ::= { atmSoftPVccEntry 9 }

```

```

atmSoftPVccRetryInterval      OBJECT-TYPE
SYNTAX      INTEGER (0..3600)
UNITS       "seconds"
MAX-ACCESS  read-create
STATUS      current
DESCRIPTION
    "Defines the period to wait before attempting
    to establish the Soft PVCC after the first failed call
    attempt. The time to wait between subsequent call
    attempts may differ to implement a backoff scheme.
    Zero represents an infinite interval indicating no
    retries."
DEFVAL { 10 }
 ::= { atmSoftPVccEntry 10 }

```

```

atmSoftPVccRetryTimer      OBJECT-TYPE
SYNTAX      INTEGER (0..86400)
UNITS       "seconds"
MAX-ACCESS  read-only
STATUS      current
DESCRIPTION
    "Indicates the current value of the retry timer for
    this connection. When the value reaches zero an attempt
    will be made to establish the Soft PVCC. When the timer
    is not running, the value zero shall be returned."
 ::= { atmSoftPVccEntry 11 }

```

```

atmSoftPVccRetryThreshold  OBJECT-TYPE
SYNTAX      INTEGER (0..65535)
MAX-ACCESS  read-create
STATUS      current
DESCRIPTION
    "Indicates the number of consecutive call setup attempts for
    the same Soft PVCC which need to fail before the
    atmSoftPvcCallFailures object is incremented. A value of
    zero indicates that an infinite number of call attempts
    are required to increment the atmSoftPvcCallFailures object
    and thus disables alarms for the Soft PVCC."
DEFVAL { 1 }
 ::= { atmSoftPVccEntry 12 }

```

```

atmSoftPVccRetryFailures      OBJECT-TYPE
    SYNTAX Gauge32
    MAX-ACCESS read-only
    STATUS current
    DESCRIPTION
        "Indicates how many attempts to establish the connection
        have failed. This count is reset whenever a connection
        is successfully established or the Soft PVCC is restarted."
    ::= { atmSoftPVccEntry 13 }

```

```

atmSoftPVccRetryLimit        OBJECT-TYPE
    SYNTAX INTEGER (0..65535)
    MAX-ACCESS read-create
    STATUS current
    DESCRIPTION
        "Sets a maximum limit on how many consecutive unsuccessful
        call setup attempts can be made before stopping the attempt
        to set up the connection. If this limit is reached then
        management action will be required (e.g. setting
        atmSoftPVccRestart to 'restart') to initiate a new attempt
        to establish the connection. A value of zero indicates
        no limit - the attempts will continue until successful."
    DEFVAL { 0 }
    ::= { atmSoftPVccEntry 14 }

```

```

atmSoftPVccRowStatus        OBJECT-TYPE
    SYNTAX RowStatus
    MAX-ACCESS read-create
    STATUS current
    DESCRIPTION
        "Used to create and delete a Soft PVCC. When this
        object is set to 'active' an attempt is made to
        set up the Soft PVCC. When this object has the value
        'active' and is set to another value, any
        set-up or connection in-progress is released."
    ::= { atmSoftPVccEntry 15 }

```

```

atmSoftPVccTargetDlci       OBJECT-TYPE
    SYNTAX Integer32
    MAX-ACCESS read-create
    STATUS current
    DESCRIPTION
        "The DLCI value at the target Frame Relay interface.

        This value is not relevant when the value of
        atmSoftPVccTargetType is other than 'frameRelay' or
        when the atmSoftPVccTargetSelectType is 'any'."
    ::= { atmSoftPVccEntry 16 }

```

```

atmSoftPVccTargetType       OBJECT-TYPE
    SYNTAX INTEGER {
        other(1),
        atm(2),
        frameRelay(3)
    }
    MAX-ACCESS read-create

```

```

STATUS current
DESCRIPTION
    "The protocol (e.g. ATM, Frame Relay) used at the target
    interface.

    The atmSoftPVccTargetVpci and atmSoftPVccTargetVci
    objects are only relevant if the target protocol is
    'atm'. Otherwise, no VPCI/VCI should be included in the
    SETUP message.

    The atmSoftPVccTargetDlci object is only relevant if the
    target protocol is 'frameRelay'. Otherwise, no DLCI
    should be included in the SETUP message."
DEFVAL { atm }
::= { atmSoftPVccEntry 17 }

atmSoftPVccTargetVpci OBJECT-TYPE
    SYNTAX INTEGER (0..65535)
    MAX-ACCESS read-create
    STATUS current
    DESCRIPTION
        "The VPCI value of the VCL used at the target interface.

        This value is not relevant when the value of
        atmSoftPVccTargetSelectType is 'any'."
    DEFVAL { 0 }
    ::= { atmSoftPVccEntry 18 }

-- Table to manage Soft PVPCs
--
--
-- The following MIB definition includes support for point to
-- multipoint Soft PVPCs. Version 1.0 of the PNNI specification does
-- not allow the use of point to multipoint Soft PVPCs. The value
-- of atmSoftPVpcLeafReference should always be set to 1 indicating
-- a point to point Soft PVPC.
--
--

atmSoftPVpcTable OBJECT-TYPE
    SYNTAX SEQUENCE OF AtmSoftPVpcEntry
    MAX-ACCESS not-accessible
    STATUS current
    DESCRIPTION
        "The (conceptual) table used to manage Soft
        Permanent Virtual Path Connections (Soft PVPCs)
        The Soft PVPC table is applicable only to switches."
    ::= { atmSoftPvcMIBObjects 3 }

atmSoftPVpcEntry OBJECT-TYPE
    SYNTAX AtmSoftPVpcEntry
    MAX-ACCESS not-accessible
    STATUS current
    DESCRIPTION
        "Each entry in this table represents a Soft
        Permanent Virtual Path Connection (Soft PVPC)
        originating at a switch interface.

```

A Soft PVPC is a VPC that is:

- provisioned at the originating (source) interface of the connection
- established by signalling procedures across a network to a destination interface.

A row in the atmVplTable must be created, defining a VPL on the source interface, prior to creating an atmSoftPVpcEntry row. The row in the atmVplTable must be active prior to activating the atmSoftPVpcEntry row.

The contents of this table reflect only the characteristics unique to a Soft PVPC. The traffic parameters are defined in the VPL row for the source interface, as specified in the ATOMMIB (RFC2515) and the forthcoming addition, the Supplemental ATOMMIB.

When a row is made active, an attempt is made to set up a switched connection to an interface at the destination switch. No objects (other than atmSoftPVpcRowStatus) can be set while the row is active.

At the destination, the VPL may be defined (but not cross-connected) prior to arrival of the Setup request.

The combination of ifIndex, atmVplVpi specified in the index clause of this entry serves to identify the VPL on the source interface. The atmSoftPVpcLeafReference object aids in distinguishing between leaves of a point-to-multipoint Soft PVPC."

```
INDEX { ifIndex,
        atmVplVpi,
        atmSoftPVpcLeafReference }
 ::= { atmSoftPVpcTable 1 }
```

```
AtmSoftPVpcEntry ::=
  SEQUENCE {
    atmSoftPVpcLeafReference          INTEGER,
    atmSoftPVpcTargetAddress          AtmAddr,
    atmSoftPVpcTargetSelectType      INTEGER,
    atmSoftPVpcTargetVpi             INTEGER,
    atmSoftPVpcLastReleaseCause      INTEGER,
    atmSoftPVpcLastReleaseDiagnostic OCTET STRING,
    atmSoftPVpcOperStatus            INTEGER,
    atmSoftPVpcRestart               INTEGER,
    atmSoftPVpcRetryInterval         INTEGER,
    atmSoftPVpcRetryTimer            INTEGER,
    atmSoftPVpcRetryThreshold        INTEGER,
    atmSoftPVpcRetryFailures         Gauge32,
    atmSoftPVpcRetryLimit            INTEGER,
    atmSoftPVpcRowStatus             RowStatus,
    atmSoftPVpcTargetVpci            INTEGER
  }
```

```
atmSoftPVpcLeafReference          OBJECT-TYPE
  SYNTAX  INTEGER (1..63535)
```

```

MAX-ACCESS      not-accessible
STATUS          current
DESCRIPTION
    "An arbitrary integer which, in the case of the
    source VPL having a atmVplCastType of
    'p2mpRoot', serves to distinguish between the
    multiple leaves attached to a root of a
    point-to-multipoint Soft PVPC.

    If the atmVplCastType is not 'p2mpRoot', the
    value 1 shall be used."
 ::= { atmSoftPVpcEntry 1 }

```

```

atmSoftPVpcTargetAddress      OBJECT-TYPE
SYNTAX      AtmAddr
MAX-ACCESS  read-create
STATUS      current
DESCRIPTION
    "The target ATM Address of this Soft PVPC.  If no
    address is supplied, no attempts to establish the
    Soft PVPC are initiated."
 ::= { atmSoftPVpcEntry 2 }

```

```

atmSoftPVpcTargetSelectType    OBJECT-TYPE
SYNTAX      INTEGER {
                required(1),
                any(2)
            }
MAX-ACCESS  read-create
STATUS      current
DESCRIPTION
    "Indicates whether the target VPCI value
    is to be used at the destination.
    If the value 'any' is specified, the
    destination switch will choose the VPCI
    value.  In such a case, once the Soft PVPC
    atmSoftPVpcOperStatus value is 'connected',
    the value of this object changes to 'required',
    such that the same VPCI value will continue to
    be used even if the connection is subsequently
    torn down and re-established.  The VPCI value
    chosen will be available for reading in
    atmSoftPVpcTargetVpci.

    If the value 'required' is specified, then
    a value must be supplied for object
    atmSoftPVpcTargetVpci prior to activation
    of the row.  This value is then to be used
    at the destination."
DEFVAL { required }
 ::= { atmSoftPVpcEntry 3 }

```

```

atmSoftPVpcTargetVpi          OBJECT-TYPE
SYNTAX      INTEGER (0..4095)
MAX-ACCESS  read-create
STATUS      deprecated
DESCRIPTION
    "The VPI value of the VPL used at the

```

target interface.

This value must be filled in when the atmSoftPVpcTargetSelectType is set to 'required'. This value is not relevant when the value of atmSoftPVpcTargetSelectType is 'any'.

This object is replaced by the new object atmSoftPVpcTargetVpci."

```
::= { atmSoftPVpcEntry 4 }
```

atmSoftPVpcLastReleaseCause OBJECT-TYPE

SYNTAX INTEGER(1..127)

MAX-ACCESS read-only

STATUS current

DESCRIPTION

"Value of the Cause field of the Cause Information Element in the last RELEASE signalling message received for this Soft PVPC. Indicates the reason for the Release."

```
::= { atmSoftPVpcEntry 5 }
```

atmSoftPVpcLastReleaseDiagnostic OBJECT-TYPE

SYNTAX OCTET STRING (SIZE(0..8))

MAX-ACCESS read-only

STATUS current

DESCRIPTION

"Value of the first 8 bytes of diagnostic information from the Cause field of the Cause Information Element in the last RELEASE signalling message received for this Soft PVPC."

```
::= { atmSoftPVpcEntry 6 }
```

atmSoftPVpcOperStatus OBJECT-TYPE

SYNTAX INTEGER {

other(1),
establishmentInProgress(2),
connected(3),
retriesExhausted(4),
noAddressSupplied(5),
lowerLayerDown(6)
}

MAX-ACCESS read-only

STATUS current

DESCRIPTION

"Describes the status of the Soft PVPC.

other	- none of the types specified below
establishmentInProgress	- connection or party is not operational, but setup or add party attempts are ongoing
connected	- connection or party is currently operational
retriesExhausted	- retry limit has been reached and setup or add party attempts have ceased
noAddressSupplied	- no remote address has been configured, so no setup or add party attempts are initiated

```

        lowerLayerDown      - underlying ATM interface is not
                             operational
        When the row is not 'active', the value of this
        object is 'other.'"
 ::= { atmSoftPVpcEntry 7 }

atmSoftPVpcRestart        OBJECT-TYPE
    SYNTAX  INTEGER {
                                restart(1),
                                noop(2)
                            }
    MAX-ACCESS      read-create
    STATUS      current
    DESCRIPTION
        "When the value is set to 'restart', the Soft PVPC is
        released if necessary and a new setup procedure is begun.
        As a result of this action, the atmSoftPVpcOperStatus
        object transitions to 'establishmentInProgress' (if not
        already in this state) and the atmSoftPVpcRetryFailures
        object is cleared.

        When the value is set to 'noop', no operation is performed.
        When read, the value 'noop' is returned."
 ::= { atmSoftPVpcEntry 8 }

atmSoftPVpcRetryInterval  OBJECT-TYPE
    SYNTAX  INTEGER (0..3600)
    UNITS      "seconds"
    MAX-ACCESS      read-create
    STATUS      current
    DESCRIPTION
        "Defines the period to wait before attempting
        to establish the Soft PVPC after the first failed
        call attempt. The time to wait between subsequent
        call attempts may differ to implement a backoff scheme.
        Zero represents an infinite interval indicating no
        retries."
    DEFVAL { 10 }
 ::= { atmSoftPVpcEntry 9 }

atmSoftPVpcRetryTimer     OBJECT-TYPE
    SYNTAX  INTEGER (0..86400)
    UNITS      "seconds"
    MAX-ACCESS      read-only
    STATUS      current
    DESCRIPTION
        "Indicates the current value of the retry timer for
        this connection. When the value reaches zero an attempt
        will be made to establish the Soft PVPC. When the
        timer is not running, the value zero shall be returned."
 ::= { atmSoftPVpcEntry 10 }

atmSoftPVpcRetryThreshold OBJECT-TYPE
    SYNTAX  INTEGER (0..65535)
    MAX-ACCESS      read-create
    STATUS      current
    DESCRIPTION

```

"Indicates the number of consecutive call setup attempts for the same Soft PVPC which need to fail before the atmSoftPvcCallFailures object is incremented. A value of zero indicates that an infinite number of call attempts are required to increment the atmSoftPvcCallFailures object and thus disables alarms for the Soft PVPC."

```
DEFVAL { 1 }
::= { atmSoftPVpcEntry 11 }
```

atmSoftPVpcRetryFailures OBJECT-TYPE

SYNTAX Gauge32

MAX-ACCESS read-only

STATUS current

DESCRIPTION

"Indicates how many attempts to establish the connection have failed. This count is reset whenever a connection is successfully established or the Soft PVPC is restarted."

```
::= { atmSoftPVpcEntry 12 }
```

atmSoftPVpcRetryLimit OBJECT-TYPE

SYNTAX INTEGER (0..65535)

MAX-ACCESS read-create

STATUS current

DESCRIPTION

"Sets a maximum limit on how many consecutive unsuccessful call setup attempts can be made before stopping the attempt to set up the connection. If this limit is reached then management action will be required (e.g. setting atmSoftPVpcRestart to 'restart') to initiate a new attempt to establish the connection. A value of zero indicates no limit - the attempts will continue until successful."

```
DEFVAL { 0 }
::= { atmSoftPVpcEntry 13 }
```

atmSoftPVpcRowStatus OBJECT-TYPE

SYNTAX RowStatus

MAX-ACCESS read-create

STATUS current

DESCRIPTION

"Used to create and delete a Soft PVPC. When this object is set to 'active' an attempt is made to set up the Soft PVPC. When this object has the value 'active' and is set to another value, any set-up or connection in-progress is released."

```
::= { atmSoftPVpcEntry 14 }
```

atmSoftPVpcTargetVpci OBJECT-TYPE

SYNTAX INTEGER (0..65535)

MAX-ACCESS read-create

STATUS current

DESCRIPTION

"The VPCI value of the VPL used at the target interface.

This value must be filled in when the atmSoftPVpcTargetSelectType is set to 'required'. This value is not relevant when the value of atmSoftPVpcTargetSelectType is 'any'."

```

 ::= { atmSoftPvPcEntry 15 }

--
-- This table is used to configure one or more ATM addresses
-- prior to setting up Soft PVCCs or Soft PVPCs at an
-- interface in a node. The interface will normally be an ATM
-- interface, but other interface types may also use this table
-- for interworking with ATM.
-- In addition, prior to setting up a Soft PVC at the source
-- interface, this table can be consulted at the destination
-- interface.
--

atmInterfaceSoftPvcAddressTable OBJECT-TYPE
    SYNTAX SEQUENCE OF AtmInterfaceSoftPvcAddressEntry
    MAX-ACCESS not-accessible
    STATUS current
    DESCRIPTION
        "This table is used to configure ATM addresses at
        an interface on this node prior to setting up
        Soft PVPCs or Soft PVCCs at that interface."
    ::= { atmSoftPvcMIBObjects 4 }

atmInterfaceSoftPvcAddressEntry OBJECT-TYPE
    SYNTAX AtmInterfaceSoftPvcAddressEntry
    MAX-ACCESS not-accessible
    STATUS current
    DESCRIPTION
        "ATM address entry for configuring Soft PVCCs or
        Soft PVPCs at an interface."
    INDEX { ifIndex, atmInterfaceSoftPvcAddress }
    ::= { atmInterfaceSoftPvcAddressTable 1 }

AtmInterfaceSoftPvcAddressEntry ::=
    SEQUENCE {
        atmInterfaceSoftPvcAddress          AtmAddr,
        atmInterfaceSoftPvcAddressRowStatus RowStatus
    }

atmInterfaceSoftPvcAddress OBJECT-TYPE
    SYNTAX AtmAddr
    MAX-ACCESS not-accessible
    STATUS current
    DESCRIPTION
        "Specifies the address that can be used to establish a Soft
        PVCC or Soft PVPC to this interface."
    ::= { atmInterfaceSoftPvcAddressEntry 1 }

atmInterfaceSoftPvcAddressRowStatus OBJECT-TYPE
    SYNTAX RowStatus
    MAX-ACCESS read-create
    STATUS current
    DESCRIPTION
        "Used to create and delete an ATM address at this interface
        for setting up Soft PVCCs or Soft PVPCs."
    ::= { atmInterfaceSoftPvcAddressEntry 2 }

```

-- Currently Failing Soft PVCC table

```

atmCurrentlyFailingSoftPVccTable          OBJECT-TYPE
    SYNTAX SEQUENCE OF AtmCurrentlyFailingSoftPVccEntry
    MAX-ACCESS not-accessible
    STATUS current
    DESCRIPTION
        "A table indicating all Soft Permanent Virtual Channel
        Connections (Soft PVCCs) for which the atmSoftPVccRowStatus
        is 'active' and the atmSoftPVccOperStatus is other than
        'connected'."
    ::= { atmSoftPvcMIBObjects 5 }

```

```

atmCurrentlyFailingSoftPVccEntry          OBJECT-TYPE
    SYNTAX AtmCurrentlyFailingSoftPVccEntry
    MAX-ACCESS not-accessible
    STATUS current
    DESCRIPTION
        "Each entry in this table represents a Soft Permanent
        Virtual Channel Connection (Soft PVCC) for which the
        atmSoftPVccRowStatus is 'active' and the
        atmSoftPVccOperStatus is other than 'connected'."
    INDEX { ifIndex,
            atmVclVpi,
            atmVclVci,
            atmSoftPVccLeafReference }
    ::= { atmCurrentlyFailingSoftPVccTable 1 }

```

```

AtmCurrentlyFailingSoftPVccEntry ::=
    SEQUENCE {
        atmCurrentlyFailingSoftPVccTimeStamp    TimeStamp
    }

```

```

atmCurrentlyFailingSoftPVccTimeStamp      OBJECT-TYPE
    SYNTAX TimeStamp
    MAX-ACCESS read-only
    STATUS current
    DESCRIPTION
        "The time at which this Soft PVCC began to fail."
    ::= { atmCurrentlyFailingSoftPVccEntry 1 }

```

-- Currently Failing Soft PVPC table

```

atmCurrentlyFailingSoftPVpcTable          OBJECT-TYPE
    SYNTAX SEQUENCE OF AtmCurrentlyFailingSoftPVpcEntry
    MAX-ACCESS not-accessible
    STATUS current
    DESCRIPTION
        "A table indicating all Soft Permanent Virtual Path
        Connections (Soft PVPCs) for which the atmSoftPVpcRowStatus
        is 'active' and the atmSoftPVpcOperStatus is other than
        'connected'."

```

```

 ::= { atmSoftPvcMIBObjects 6 }

atmCurrentlyFailingSoftPVpcEntry      OBJECT-TYPE
    SYNTAX      AtmCurrentlyFailingSoftPVpcEntry
    MAX-ACCESS   not-accessible
    STATUS      current
    DESCRIPTION
        "Each entry in this table represents a Soft Permanent
        Virtual Path Connection (Soft PVPC) for which the
        atmSoftPVpcRowStatus is 'active' and the
        atmSoftPVpcOperStatus is other than 'connected'."
    INDEX { ifIndex,
            atmVclVpi,
            atmSoftPVpcLeafReference }
 ::= { atmCurrentlyFailingSoftPVpcTable 1 }

AtmCurrentlyFailingSoftPVpcEntry ::=
    SEQUENCE {
        atmCurrentlyFailingSoftPVpcTimeStamp      TimeStamp
    }

atmCurrentlyFailingSoftPVpcTimeStamp  OBJECT-TYPE
    SYNTAX      TimeStamp
    MAX-ACCESS   read-only
    STATUS      current
    DESCRIPTION
        "The time at which this Soft PVPC began to fail."
 ::= { atmCurrentlyFailingSoftPVpcEntry 1 }

-- Soft PVC Traps

atmSoftPvcTraps      OBJECT IDENTIFIER ::= { atmSoftPvcMIBTraps 1 }
atmSoftPvcTrapsPrefix OBJECT IDENTIFIER ::= { atmSoftPvcTraps 0 }

atmSoftPvcCallFailuresTrap      NOTIFICATION-TYPE
    OBJECTS { atmSoftPvcCallFailures,
              atmSoftPvcCurrentlyFailingSoftPVccs,
              atmSoftPvcCurrentlyFailingSoftPVpcs }
    STATUS      current
    DESCRIPTION
        "A notification indicating that one or more series of
        call attempts in trying to establish a Soft PVPC or
        Soft PVCC have failed since the last
        atmSoftPvcCallFailureTrap was sent. If this trap has
        not been sent for the last atmSoftPvcNotificationInterval,
        then it will be sent on the next increment of
        atmSoftPvcCallFailures."
 ::= { atmSoftPvcTrapsPrefix 1 }

-- conformance information

atmSoftPvcMIBConformance
    OBJECT IDENTIFIER ::= { atmSoftPvcMIB 3 }
atmSoftPvcMIBCompliances
    OBJECT IDENTIFIER ::= { atmSoftPvcMIBConformance 1 }

```



```

atmSoftPvcMIBGroups
    OBJECT IDENTIFIER ::= { atmSoftPvcMIBConformance 2 }

-- compliance statements

atmSoftPvcMIBCompliance2  MODULE-COMPLIANCE
    STATUS current
    DESCRIPTION
        "The compliance statement for the ATM Soft PVC group."
    MODULE -- this module
    MANDATORY-GROUPS
        { atmSoftPvcBaseMIBGroup, atmSoftPvcVccMIBGroup2,
          atmSoftPvcAddressMIBGroup
        }
    OBJECT atmSoftPVccRetryLimit
    MIN-ACCESS read-only
    DESCRIPTION
        "Write access not required."

    GROUP atmSoftPvcVpcMIBGroup2
    DESCRIPTION
        "Required if Soft PVPCs are supported."

    OBJECT atmSoftPVpcRetryLimit
    MIN-ACCESS read-only
    DESCRIPTION
        "Write access not required."

    GROUP atmSoftPvcVccFrameRelayMIBGroup
    DESCRIPTION
        "Required if interworking of ATM and Frame Relay
        Soft PVCCs is supported."

    GROUP atmSoftPvcCallFailuresEventGroup
    DESCRIPTION
        "Call failures events are optional."

    ::= { atmSoftPvcMIBCompliances 2 }

-- units of conformance

atmSoftPvcBaseMIBGroup  OBJECT-GROUP
    OBJECTS {
        atmSoftPvcCallFailuresTrapEnable,
        atmSoftPvcCallFailures,
        atmSoftPvcCurrentlyFailingSoftPVccs,
        atmSoftPvcCurrentlyFailingSoftPVpcs,
        atmSoftPvcNotificationInterval
    }
    STATUS current
    DESCRIPTION
        "A collection of objects to related to failing
        Soft PVCCs and Soft PVPCs."
    ::= { atmSoftPvcMIBGroups 1 }

atmSoftPvcAddressMIBGroup  OBJECT-GROUP
    OBJECTS {
        atmInterfaceSoftPvcAddressRowStatus

```

```

    }
    STATUS current
    DESCRIPTION
        "A collection of objects managing interfaces addresses for
        Soft PVCCs and Soft PVPCs."
    ::= { atmSoftPvcMIBGroups 4 }

atmCurrentlyFailingSoftPVccMIBGroup OBJECT-GROUP
    OBJECTS {
        atmCurrentlyFailingSoftPVccTimeStamp
    }
    STATUS current
    DESCRIPTION
        "A collection of objects for management of currently
        failing Soft PVCCs."
    ::= { atmSoftPvcMIBGroups 5 }

atmCurrentlyFailingSoftPVpcMIBGroup OBJECT-GROUP
    OBJECTS {
        atmCurrentlyFailingSoftPVpcTimeStamp
    }
    STATUS current
    DESCRIPTION
        "A collection of objects for management of currently
        failing Soft PVPCs."
    ::= { atmSoftPvcMIBGroups 6 }

atmSoftPvcVccMIBGroup2 OBJECT-GROUP
    OBJECTS {
        atmSoftPVccTargetAddress,
        atmSoftPVccTargetSelectType, atmSoftPVccTargetVpci,
        atmSoftPVccTargetVci, atmSoftPVccLastReleaseCause,
        atmSoftPVccLastReleaseDiagnostic,
        atmSoftPVccOperStatus, atmSoftPVccRestart,
        atmSoftPVccRetryInterval,
        atmSoftPVccRetryTimer, atmSoftPVccRetryThreshold,
        atmSoftPVccRetryFailures, atmSoftPVccRetryLimit,
        atmSoftPVccRowStatus, atmSoftPVccTargetType
    }
    STATUS current
    DESCRIPTION
        "A collection of objects managing Soft PVCCs."
    ::= { atmSoftPvcMIBGroups 7 }

atmSoftPvcVpcMIBGroup2 OBJECT-GROUP
    OBJECTS {
        atmSoftPVpcTargetAddress,
        atmSoftPVpcTargetSelectType, atmSoftPVpcTargetVpci,
        atmSoftPVpcLastReleaseCause,
        atmSoftPVpcLastReleaseDiagnostic,
        atmSoftPVpcOperStatus, atmSoftPVpcRestart,
        atmSoftPVpcRetryInterval,
        atmSoftPVpcRetryTimer, atmSoftPVpcRetryThreshold,
        atmSoftPVpcRetryFailures,
        atmSoftPVpcRetryLimit, atmSoftPVpcRowStatus
    }
    STATUS current

```

```

DESCRIPTION
    "A collection of objects managing Soft PVPCs."
 ::= { atmSoftPvcMIBGroups 8 }

atmSoftPvcVccFrameRelayMIBGroup OBJECT-GROUP
    OBJECTS {
        atmSoftPVccTargetDlci
    }
    STATUS current
    DESCRIPTION
        "A collection of objects managing ATM/Frame Relay
        Soft PVCCs."
 ::= { atmSoftPvcMIBGroups 9 }

atmSoftPvcCallFailuresEventGroup NOTIFICATION-GROUP
    NOTIFICATIONS {
        atmSoftPvcCallFailuresTrap
    }
    STATUS current
    DESCRIPTION
        "Call failure events"
 ::= { atmSoftPvcMIBGroups 10 }

-- deprecated definitions - objects

-- atmSoftPVccTargetVpi
-- atmSoftPVpcTargetVpi

-- deprecated definitions - compliance statements

atmSoftPvcMIBCompliance MODULE-COMPLIANCE
    STATUS deprecated
    DESCRIPTION
        "The compliance statement for the ATM Soft PVC group."
    MODULE -- this module
    MANDATORY-GROUPS
        { atmSoftPvcBaseMIBGroup, atmSoftPvcVccMIBGroup,
          atmSoftPvcAddressMIBGroup
        }
    OBJECT atmSoftPVccRetryLimit
    MIN-ACCESS read-only
    DESCRIPTION
        "Write access not required."

    GROUP atmSoftPvcVpcMIBGroup
    DESCRIPTION
        "Required if Soft PVPCs are supported."

    OBJECT atmSoftPVpcRetryLimit
    MIN-ACCESS read-only
    DESCRIPTION
        "Write access not required."

 ::= { atmSoftPvcMIBCompliances 1 }

-- deprecated definitions - units of conformance

```

```
atmSoftPvcVccMIBGroup    OBJECT-GROUP
  OBJECTS {
    atmSoftPVccTargetAddress,
    atmSoftPVccTargetSelectType, atmSoftPVccTargetVpi,
    atmSoftPVccTargetVci, atmSoftPVccLastReleaseCause,
    atmSoftPVccLastReleaseDiagnostic,
    atmSoftPVccOperStatus, atmSoftPVccRestart,
    atmSoftPVccRetryInterval,
    atmSoftPVccRetryTimer, atmSoftPVccRetryThreshold,
    atmSoftPVccRetryFailures, atmSoftPVccRetryLimit,
    atmSoftPVccRowStatus
  }
  STATUS deprecated
  DESCRIPTION
    "A collection of objects managing Soft PVCCs."
  ::= { atmSoftPvcMIBGroups 2 }
```

```
atmSoftPvcVpcMIBGroup    OBJECT-GROUP
  OBJECTS {
    atmSoftPVpcTargetAddress,
    atmSoftPVpcTargetSelectType, atmSoftPVpcTargetVpi,
    atmSoftPVpcLastReleaseCause,
    atmSoftPVpcLastReleaseDiagnostic,
    atmSoftPVpcOperStatus, atmSoftPVpcRestart,
    atmSoftPVpcRetryInterval,
    atmSoftPVpcRetryTimer, atmSoftPVpcRetryThreshold,
    atmSoftPVpcRetryFailures,
    atmSoftPVpcRetryLimit, atmSoftPVpcRowStatus
  }
  STATUS deprecated
  DESCRIPTION
    "A collection of objects managing Soft PVPCs."
  ::= { atmSoftPvcMIBGroups 3 }
```

END

15. Annex I: Protocol Implementation Conformance Statement (PICS) Proforma**15.1 PNNI 1.1 PICS Proforma****15.1.1 Introduction**

To evaluate conformance of a particular implementation, it is necessary to have a statement of which capabilities and options have been implemented for a telecommunication specification. Such a statement is called a Protocol Implementation Conformance Statement (PICS).

This particular PICS deals with the implementation of the Private Network to Network Interface.

15.1.1.1 Scope

The present document provides the Protocol Implementation Conformance Statement (PICS) proforma for the Private Network–Network Interface Specification Version 1.1 [1], in compliance with the relevant requirements, and in accordance with the relevant guidelines, given in ISO/IEC 9646-7 [3].

15.1.1.2 Normative References

- [1] af-pnni-0055.002, Private Network - Network Interface Specification Version 1.1 (PNNI 1.1), (April 2002).
- [2] ISO/IEC 9646-1: 1994, Information technology - Open Systems interconnection - Conformance testing methodology and framework - Part 1: General concepts (see also ITU-T Recommendation X.290 (1995)).
- [3] ISO/IEC 9646-7: 1995, Information technology - Open Systems interconnection - Conformance testing methodology and framework - Part 7: Implementation Conformance Statements (see also ITU-T Recommendation X.296 (1995)).
- [4] ISO/IEC 9646-3: 1998, Information technology - Open Systems interconnection - Conformance testing methodology and framework - Part 3: The Tree and Tabular Combined Notation (TTCN) (see also ITU-T Recommendation X.292 (1998)).

15.1.1.3 Definitions

AND	Boolean 'and'
ATM	Asynchronous Transfer Mode
HEC	Header Error Control
IUT	Implementation Under Test
M	Mandatory
N/A	Not applicable
NOT	item not supported; absence of item
O	Optional
O.<n>	Optional, but, if chosen, support is required for either at least one or only one of the options in the group labelled by the same numeral <n>
PDU	Protocol Data Unit
PNNI	Private Network to Network Interface
S.<i>	Supplementary information number i
SAR	Segmentation and Reassembly (Sublayer)
SDU	Service Data Unit
SS	Switching System
SUT	System Under Test
TC	Transmission Convergence
X.<i>	Exceptional information number i
‡	Indicates PICS question is clarified or modified by the PNNI V1.0 Errata

15.1.1.4 Conformance Statement

This ICS does not modify any of the requirements detailed in af-pnni-0055.002. In case of apparent conflict between the statements in the base specification and the annotations of "M" (mandatory) and "O" (optional) in this ICS, the text of the base specification takes precedence.

For each protocol implementation for which conformance is claimed to the ATM Forum af-pnni-0055.002, the supplier is required to complete a copy of the PICS proforma provided in this document and is required to provide the information necessary to identify both the supplier and the implementation.

15.1.2 Identification of the Implementation

Identification of the Implementation Under Test (IUT) and the system in which it resides (the System Under Test (SUT)) should be filled in so as to provide as much detail as possible regarding version numbers and configuration options.

The product supplier information and client information should both be filled in if they are different.

A person who can answer queries regarding information supplied in the ICS should be named as the contact person.

Implementation Under Test (IUT) Identification

IUT Name: _____

IUT Version: _____

System Under Test

SUT Name: _____

Hardware Configuration: _____

Operating System: _____

Product Supplier

Name: _____

Address: _____

Telephone Number: _____

Facsimile Number: _____

Email Address (optional): _____

Additional Information: _____

Client

Name: _____

Address: _____

Telephone Number: _____

Facsimile Number: _____

Email Address (optional): _____

Additional Information: _____

PICS Contact Person

(A person to contact if there are any queries concerning the content of the ICS)

Name _____

Address: _____

Telephone Number: _____

Facsimile Number: _____

Email Address (optional): _____

Additional Information: _____

PICS PICS-System Conformance Statement

Provide the relationship of the PICS with the System Conformance Statement for the system:

Identification of the protocol

This PICS proforma applies to the following standard:

af-pnni-0055.002, "Private Network-Network Interface Specification Version 1.1 (PNNI 1.1)", April 2002

15.1.3 PICS Proforma

15.1.3.1 Global Statement of Conformance

The implementation described in this PICS meets all of the mandatory requirements of the reference protocol.

Yes

No

Note: Answering "No" indicates non-conformance to the specified protocol. Non-supported mandatory capabilities are to be identified in the following tables, with an explanation in the comments section of each table of why the implementation is non-conforming.

15.1.3.2 Instructions for Completing the PICS Proforma

The PICS Proforma is a fixed-format questionnaire. Answers to the questionnaire should be provided in the rightmost columns, either by simply indicating a restricted choice (such as Yes or No), or by entering a value or a set of range of values.

Some tables use two columns for status. The first column is the "Conditions for status" column. The second column is the "Status Predicate" column. The "Conditions for status" column indicates which status in the "Status Predicate" is to be used. For example, the table in section 3.3 uses two columns for status. PICS item SS_B is read as: "This item is mandatory for implementations supporting the border node capable switching system with peer support subset (SS_N) (i.e., answered yes to PICS SS_N) and optional for those implementations not implementing border node capable switching system with LGN peer support (NOT SS_N)."

For those tables that only have one status column, "Status Predicate," the condition for status is assumed to be the minimum implementation (i.e., the IUT supports the minimum function switching system subset, SS_M). For example, the table in section 3.4 uses only one column for status. All PICS questions in this table are applicable for implementations supporting the minimum function switching system subset (i.e., answered yes to PICS SS_M).

A supplier may also provide additional information, categorized as exceptional or supplementary information. This additional information should be provided as items labelled X.<i> for exceptional information, or S.<i> for supplemental information, respectively, for cross reference purposes, where <i> is any unambiguous identification for the item. An exception item should contain the appropriate rationale. For example, if an IUT does not implement a feature listed in the "Conditions for status" column, such as in PICS SS_B, where the IUT does not support the border node capable switching system with LGN peer support subset (SS_N), the Support column of the PICS proforma table should be completed as Yes__ No__ X: X.1.

"X.1 This implementation does not support the border node capable switching system with LGN peer support subset."

Note: X.1 is used if this is the first Exceptional Information item.

The supplementary information is not mandatory and the PICS is complete without such information. The presence of optional supplementary or exception information should not affect test execution, and will in no way affect interoperability verification.

Note: Where an implementation is capable of being configured in more than one way, a single PICS may be able to describe all such configurations. However, the supplier has the choice of providing more than one PICS, each covering some subset of the implementation's configuration capabilities, in case this makes for easier or clearer presentation of the information.

15.1.3.3 Switching System Subsets (SS)

Item	Protocol Feature	Conditions for status	Status Pred.	Spec. Ref.	Support
SS_M	Does the IUT support the minimum function switching system subset?		M	Annex G	Yes_ No_ X_ S_
SS_P	Does the IUT support the PGL/LGN switching system subset?		O	Annex G	Yes_ No_ X_ S_
SS_N	Does the IUT support the border node capable switching system with LGN peer support subset?		O	Annex G	Yes_ No_ X_ S_
SS_B	Does the IUT support the border node capable switching system subset?	SS_N NOT SS_N	M O	Annex G	Yes_ No_ X_ S_

15.1.3.4 Optional Features (OPT)

Item	Protocol Feature	Conditions for status	Status Pred.	Spec. Ref.	Support
OPT_1	Does the IUT support origination exterior of reachable address advertisements?		O	Annex G #33	Yes_ No_ X_ S_
OPT_2	Does the IUT support alternate routing as a result of crankback?		O	Annex G #34	Yes_ No_ X_ S_
OPT_3	Does the IUT support the Hello protocol over VPCs?		O	Annex G #35	Yes_ No_ X_ S_
OPT_4	Does the IUT support associated signalling?		O	Annex G #36	Yes_ No_ X_ S_
OPT_5	Does the IUT support negotiation of ATM traffic descriptors?		O	Annex G #37	Yes_ No_ X_ S_
OPT_6	Does the IUT support the switched virtual path (VP) service?		O	Annex G #38	Yes_ No_ X_ S_
OPT_7	Does the IUT support Soft PVPC and PVCC?		O	Annex G #39	Yes_ No_ X_ S_
OPT_8	Does the IUT support ABR signalling for point-to-point calls?		O	Annex G #40	Yes_ No_ X_ S_
OPT_9	Does the IUT support the Generic Identifier Transport Information Element?		O	Annex G #41	Yes_ No_ X_ S_
OPT_10	Does the IUT support frame discard?		O	Annex G #42	Yes_ No_ X_ S_
OPT_11	Does the IUT support ILMI over PNNI links?		O	Annex G #43	Yes_ No_ X_ S_
<u>OPT_12³</u>	<u>Does the IUT support enhanced summarization of AESAs with embedded addresses ?</u>		<u>O</u>	<u>Annex G #44</u>	<u>Yes_ No_ X_ S_</u>
<u>OPT_13³</u>	<u>Does the IUT support end-to-end connection completion indication?</u>		<u>O</u>	<u>Annex G #45</u>	<u>Yes_ No_ X_ S_</u>
<u>OPT_14³</u>	<u>Does the IUT support triggering a significant change event for resource availability information on call blocking?</u>		<u>O</u>	<u>Annex G #46</u>	<u>Yes_ No_ X_ S_</u>
<u>OPT_15³</u>	<u>Does the IUT support multiple administrative domains within a single PNNI routing domain?</u>		<u>O</u>	<u>Annex G #47</u>	<u>Yes_ No_ X_ S_</u>
<u>OPT_16³</u>	<u>Does the IUT support enhanced status enquiry?</u>		<u>O</u>	<u>Annex G #48</u>	<u>Yes_ No_ X_ S_</u>
<u>OPT_17³</u>	<u>Does the IUT support explicitly routed calls?</u>		<u>O</u>	<u>Annex G #49</u>	<u>Yes_ No_ X_ S_</u>
<u>OPT_18³</u>	<u>Does the IUT support the OAM traffic descriptor?</u>		<u>O</u>	<u>Annex G #50</u>	<u>Yes_ No_ X_ S_</u>

15.1.3.5 General Operational Procedures

Item	Protocol Feature	Conditions for status	Status Pred.	Spec. Ref.	Support
3.5.1	Are the IUT's timers that trigger transmission jittered?		M	5.1.1	Yes_ No_ X_ S_
3.5.2	Is a maximum range of fractional variance at most +/- 25% for timers that trigger transmission?		M	5.1.1	Yes_ No_ X_ S_
3.5.3	Is a new random fractional variance applied to the time out value each time a timer is reset?		M	5.1.1	Yes_ No_ X_ S_
3.5.4	Does the IUT encode all packets, except Hellos, according to the protocol version given by the Version field of the Hello data structure?		M	5.1.2	Yes_ No_ X_ S_
3.5.5 +	Does the IUT discard without further processing the received packet, if the length in the PNNI packet header exceeds the received data length?		M	5.1.3	Yes_ No_ X_ S_
3.5.6 +	Does the IUT discard the entire packet if the packet type in the PNNI packet header is not recognized?		M	5.1.3	Yes_ No_ X_ S_
3.5.7 +	If another parsing error, other than packet type (PICS 3.5.6) or length (PICS 3.5.5), does the IUT ignore the offending element?		O.1	5.1.3	Yes_ No_ X_ S_
3.5.8 +	If another parsing error, other than packet type (PICS 3.5.6) or length (PICS 3.5.5), does the IUT ignore the enclosing element?		O.1	5.1.3	Yes_ No_ X_ S_
3.5.9	If another parsing error, other than packet type (PICS 3.5.6) or length (PICS 3.5.5), does the IUT ignore the entire packet?		O.1	5.1.3	Yes_ No_ X_ S_
3.5.10	Does the IUT discard a packet if the packet is received with an unsupported version?		M	5.1.3, 5.6.2.3	Yes_ No_ X_ S_
3.5.11	Does the IUT discard the packet if the packet is received with a different version from the expected value, except the Hello packet?		M	5.1.3	Yes_ No_ X_ S_
COMMENTS					
O.1 The IUT must support at least one of these capabilities.					

15.1.3.6 Addressing

Item	Protocol Feature	Conditions for status	Status Pred.	Spec. Ref.	Support
3.6.1	Does the IUT support addressing and identification based on ATM End System addresses (20 bytes)?		M	5.2.1	Yes_ No_ X_ S_
3.6.2	Does the IUT's PNNI routing only operate on the first 19 octets of the ATM address?		M	5.2.1, 5.2.3 ³	Yes_ No_ X_ S_
3.6.3	Does the IUT treat the entire ATM address, other than the Authority Format Identifier (AFI), as uninterpreted binary data, <u>except for AESA formats with embedded addresses</u> ?		M	5.2.1, <u>5.2.2.1</u>	Yes_ No_ X_ S_
3.6.4	Does the IUT use the first (left) p bits as the prefix of an ATM End System address?		M	5.2.15.2.2 ³	Yes_ No_ X_ S_
3.6.5	Does the IUT use an address prefix in the range 0 152 bits?		M	5.2.15.2.2 ³	Yes_ No_ X_ S_
3.6.6	Does the IUT accept reachable address prefixes in the range 0152 to summarize portions of the addressing domain?		M	5.2.15.2.2 ³ , 5.3.2	Yes_ No_ X_ S_
3.6.7	Does the IUT make an explicit advertisement (full 152bit prefix length) for an end system that is attached and has an address that does not fit into one of the node's summary addresses?		M	5.2. 23	Yes_ No_ X_ S_
3.6.8	Does the IUT (i.e., switching system) always direct calls to a logical node that is advertising the best match (i.e., matching advertisement with the longest prefix) of wide enough scope for the given destination?		M	5.2.35.2.3 ³ , 5.13	Yes_ No_ X_ S_
3.6.9	Does the IUT (i.e., switch) direct calls to addresses for which there is no other match, to systems which advertise a zero length prefix?		M	5.2.15.2.2 ³	Yes_ No_ X_ S_
3.6.10	Does the IUT (i.e., switching system) assign a unique ATM End System Address to each node it instantiates?		M	5.2.25.2.4 ³	Yes_ No_ X_ S_
<u>3.6.11</u>	<u>For every AESA prefix with an AFI indicating the presence of an embedded address (e.g. E.164 AESA or X.121 AESA), when the end of the address prefix falls within the IDP, does the IUT modify the address prefix from the preferred binary encoding by encoding each decimal digit in the prefix as the corresponding semi-octet in the range 0000-1001 and inserting no padding characters (i.e. leading semi-octets 0000 in the IDI or trailing semi-octet 1111 in the IDI)?</u>	<u>OPT_12</u> <u>NOT OPT_12</u>	<u>M</u> <u>N/A</u>	<u>5.2.2.1</u>	<u>Yes_ No_</u> <u>X_ S_</u>
<u>3.6.12</u>	<u>For every AESA prefix with an AFI indicating the presence of an embedded address (e.g. E.164 AESA or X.121 AESA), when the address prefix includes bits of the DSP, does the IUT modify the address prefix from the preferred binary encoding by deleting all leading semi-octets 0000 within the IDI, and instead inserting an equivalent number of semi-octets 1111 at the end of the IDI to pad the IDI out to its original length?</u> ³	<u>OPT_12</u> <u>NOT OPT_12</u>	<u>M</u> <u>N/A</u>	<u>5.2.2.1</u>	<u>Yes_ No_</u> <u>X_ S_</u>

3.6.13	<p><u>When checking for a match between an AESA with an AFI indicating an embedded address and an address prefix, does the IUT either</u></p> <ul style="list-style-type: none"> <u>first transform the AESA by deleting all leading semi-octets 0000 within the IDI, and instead inserting an equivalent number of semi-octets 1111 at the end of the IDI to pad the IDI out to its original length, before checking whether all bits of the address prefix are identical to the corresponding leading bits of the transformed AESA, or</u> <u>implement a matching process that achieves the same results?</u> 	<u>OPT_12</u> <u>NOT OPT_12</u>	<u>M</u> <u>N/A</u>	<u>5.2.3.1</u>	<u>Yes No</u> <u>X S</u>
--------	--	--	----------------------------	----------------	-----------------------------

15.1.3.7 Identifiers and indicators

Item	Protocol Feature	Conditions for status	Status Pred.	Spec. Ref.	Support
3.7.1	Is the level of a node instantiated in this switching system the same as the level of its containing peer group?		M	5.3.1, 5.3.3	Yes_ No_ X_ S_
3.7.2	Is the value of the level indicator greater than or equal to 0 and less than or equal to 104 bits?		M	5.3.1, 5.3.2	Yes_ No_ X_ S_
3.7.3	Is the encoding of the PG ID of the format, level indicator (1 octet) and ID information (13 octets)?		M	5.3.2	Yes_ No_ X_ S_
3.7.4	Is the value sent in the identifier information field encoded with the 104-n rightmost bits set to 0 where n is the level?		M	5.3.2	Yes_ No_ X_ S_
3.7.5	Are node IDs of the format: level indicator (1 octet) and opaque value (21 octets)?		M	5.3.3	Yes_ No_ X_ S_
3.7.6	Does the IUT treat the entire node ID in received packets, except for the first octet, as uninterpreted binary data?		M	5.3.3	Yes_ No_ X_ S_
3.7.7	Does the Node ID remain unchanged while the node is operational?		M	5.3.3	Yes_ No_ X_ S_
3.7.8	When ordering for PGL election, is the first byte of the node ID the most significant?		M	5.3.3	Yes_ No_ X_ S_
3.7.9	When ordering for SVCC RCC establishment, is the first byte of the node ID the most significant?	SS_P or SS_N NOT(SS_P or SS_N)	M N/A	5.3.3	Yes_ No_ X_ S_
3.7.10	Does the port ID equal 32 bits?		M	5.3.4	Yes_ No_ X_ S_
3.7.11	Does the IUT assign specific ports values not equal to 0 or 0xFFFFFFFF?		M	5.3.4, 5.14.8, Table 5-27	Yes_ No_ X_ S_
3.7.12	Is the aggregation token 4 octets?		M	5.3.5	Yes_ No_ X_ S_
3.7.13	Is the derived Aggregation Token included in the PTSE which describes uplinks?	SS_B or SS_N or SS_P NOT (SS_B or SS_N or SS_P)	M N/A	5.3.5	Yes_ No_ X_ S_
3.7.14	Is the derived Aggregation Token included in the PTSEs which describe Horizontal links as binding information?	SS_P or SS_N NOT (SS_P or SS_N)	M N/A	5.3.5	Yes_ No_ X_ S_
3.7.15	Are two PNNI routing packets considered to be from the same source if and only if they contain identical 22octet source node IDs?		M	5.3.3	Yes_ No_ X_ S_
3.7.16	Does each advertised link from a node have a unique port ID within the context of that node?		M	5.3.4	Yes_ No_ X_ S_
3.7.17	Is a logical link identified by the node ID of either node at the end of the link and the port ID assigned by that node?		M	5.3.4	Yes_ No_ X_ S_
3.7.18	Are all links between a pair of logical group nodes with the same value of the Aggregation Token advertised as one logical link?	SS_P or SS_N NOT (SS_P or SS_N)	M N/A	5.3.5, 5.10.3.1	Yes_ No_ X_ S_

3.7.19	Does a node advertising an uplink induced by an outside link derive the advertised Aggregation token using the algorithm in section 5.10.3.1?	SS_B NOT SS_B	M N/A	5.3.5, 5.10.3.1	Yes_ No_ X_ S_
3.7.20	Is the scope of reachable addresses specified by a level indicator?		M	5.3.6	Yes_ No_ X_ S_
3.7.21	Does the mapping used to translate between the organizational scope indicated across the UNI and PNNI routing level indicators use the values in Table 5-1 by default?		M	5.3.6	Yes_ No_ X_ S_
3.7.22	Is the mapping used to translate between the organizational scope indicated across the UNI and PNNI routing level indicators configurable?		M	5.3.6	Yes_ No_ X_ S_
<u>3.7.23</u>	<u>When the value sent in the identifier information field of a peer group identifier begins with an AFI indicating the presence of an embedded address (e.g. E.164 AESA or X.121 AESA), does the IUT encode the identifier information based on the left-justified AESA prefix encoding specified in Section 5.2.2.1.</u>		<u>M</u>	<u>5.3.2</u>	<u>Yes_ No_</u> <u>X_ S_</u>

15.1.3.8 Logical Links

Item	Protocol Feature	Conditions for status	Status Pred.	Spec. Ref.	Support
3.8.1	Is no link aggregation carried out by a lowest level node for horizontal links in the same peer group?		M	3.2.2	Yes_ No_ X_ S_

15.1.3.9 PNNI Routing Control Channels

Item	Protocol Feature	Conditions for status	Status Pred.	Spec. Ref.	Support
3.9.1	Are PNNI RCC used to exchange PNNI routing packets between nodes that are logically or physically adjacent?		M	5.5	Yes_ No_ X_ S_
3.9.2	For physical links, does the IUT use the reserved VCC with VPI=0 and VCI=18?		M	5.5	Yes_ No_ X_ S_
3.9.3	For the exchange of the PNNI routing protocol over a virtual path connection with VPI=V, does the IUT's PNNI routing exchange take place over the PNNI VCC within the VPC that is VPI=V and VCI=18?	OPT_3 NOT OPT_3	M N/A	5.5	Yes_ No_ X_ S_
3.9.4	For the exchange of PNNI routing protocol messages between logical group nodes, is an SVCC established?	SS_P or SS_N NOT (SS_P or SS_N)	M N/A	5.5	Yes_ No_ X_ S_
3.9.5	Are PNNI protocol packets encapsulated in AAL5SDUs?		M	5.5.1	Yes_ No_ X_ S_
3.9.6	Does the RCC use the null SSCS?		M	5.5.1	Yes_ No_ X_ S_
3.9.7	Does the RCC use message mode?		M	5.5.1	Yes_ No_ X_ S_
3.9.8	Is one and only one complete PNNI packet encapsulated in one AAL5SDU?		M	5.5.1	Yes_ No_ X_ S_
3.9.9	Does the RCC between two lowest level nodes connected via a physical link use the following default traffic descriptor? service category is nrtVBR PCR(CLP=0+1)=RCCPeakCellRate SCR(CLP=0)=RCCSustainableCellRate MBS(CLP=0)=RCCMaximumBurstSize Tagging applied Frame discard allowed		M	5.5.2	Yes_ No_ X_ S_
3.9.10	If the service category of the of the VPC containing the RCC between two lowest level nodes is CBR, then by default does the RCC use the following default traffic descriptor? service category is CBR PCR=RCCPeakCellRate	OPT_3 NOT OPT_3	M N/A	5.5.3	Yes_ No_ X_ S_
3.9.11	If the service category of the of the VPC containing the RCC between two lowest level nodes is nrtVBR, and the SCR parameter of the VPC applies to the CLP=0 substream, then by default does the RCC use the following default traffic descriptor? service category is nrtVBR PCR(CLP=0+1)=RCCPeakCellRate SCR(CLP=0)=RCCSustainableCellRate MBS(CLP=0)=RCCMaximumBurstSize Tagging applied Frame discard allowed	OPT_3 NOT OPT_3	M N/A	5.5.3	Yes_ No_ X_ S_

3.9.12	If the service category of the of the VPC containing the RCC between two lowest level nodes is nrtVBR, and the SCR parameter of the VPC applies to the CLP=0+1 substream, then by default does the RCC use the following default traffic descriptor? service category is nrtVBR PCR(CLP=0+1)=RCCPeakCellRate SCR(CLP=0+1)=RCCSustainableCellRate MBS(CLP=0+1)=RCCMaximumBurstSize Tagging not applied Frame discard allowed	OPT_3 NOT OPT_3	M N/A	5.5.3	Yes_ No_ X_ S_
3.9.13	If the service category of the of the VPC containing the RCC between two lowest level nodes is rtVBR and the SCR parameter of the VPC applies to the CLP=0 substream, then by default does the RCC use the following default traffic descriptor? service category is rtVBR PCR(CLP=0+1)=RCCPeakCellRate SCR(CLP=0)=RCCSustainableCellRate MBS(CLP=0)=RCCMaximumBurstSize Tagging applied Frame discard allowed	OPT_3 NOT OPT_3	M N/A	5.5.3	Yes_ No_ X_ S_
3.9.14	If the service category of the of the VPC containing the RCC between two lowest level nodes is rtVBR and the SCR parameter of the VPC applies to the CLP=0+1 substream, then by default does the RCC use the following default traffic descriptor? service category is rtVBR PCR(CLP=0+1)=RCCPeakCellRate SCR(CLP=0+1)=RCCSustainableCellRate MBS(CLP=0+1)=RCCMaximumBurstSize Tagging not applied Frame discard allowed	OPT_3 NOT OPT_3	M N/A	5.5.3	Yes_ No_ X_ S_
3.9.15	If the service category of the of the VPC containing the RCC between two lowest level nodes is ABR, then by default does the RCC use the following default traffic descriptor? service category is ABR PCR=PCR for VPC MCR=0.005*MCR for VPC	OPT_3 NOT OPT_3	M N/A	5.5.3	Yes_ No_ X_ S_
3.9.16	If the service category of the of the VPC containing the RCC between two lowest level nodes is UBR, then by default does the RCC use the following default traffic descriptor? service category is UBR PCR=PCR for VPC	OPT_3 NOT OPT_3	M N/A	5.5.3	Yes_ No_ X_ S_
3.9.17	Does the IUT support the default SETUP parameter values for SVCC-based RCCs?	SS_P or SS_N NOT (SS_P or SS_N)	M N/A	5.5.4	Yes_ No_ X_ S_
3.9.18	Does the LGN first request nonrealtime VBR service for an SVCC RCC connection?	SS_P or SS_N NOT (SS_P or SS_N)	M N/A	5.5.4, 5.5.4.1.3	Yes_ No_ X_ S_

3.9.19	Does the LGN only request realtime VBR after nonreal time VBR is found not to be available for an SVCC RCC connection?	SS_P or SS_N NOT (SS_P or SS_N)	M N/A	5.5.4, 5.5.4.1.3	Yes_ No_ X_ S_
3.9.20	Does the LGN only request CBR after realtime VBR is found not to be available for an SVCC RCC connection?	SS_P or SS_N NOT (SS_P or SS_N)	M N/A	5.5.4, 5.5.4.1.3	Yes_ No_ X_ S_
3.9.21	Does the LGN only request ABR after CBR is found not to be available for an SVCC RCC connection?	(SS_P or SS_N) <u>and OPT 8</u> (NOT (SS_P or SS_N)) <u>or</u> (NOT OPT 8)	M N/A	5.5.4, 5.5.4.1.3	Yes_ No_ X_ S_
3.9.22	Does the LGN only request UBR if no other service category is available for an SVCC RCC connection?	SS_P or SS_N NOT (SS_P or SS_N)	M N/A	5.5.4, 5.5.4.1.3	Yes_ No_ X_ S_
3.9.23	For an SVCCbased RCC connection if a required information element is not present, is the call rejected by the LGN?	SS_P or SS_N NOT (SS_P or SS_N)	M N/A	5.5.4	Yes_ No_ X_ S_
3.9.24	For an SVCCbased RCC connection is the AAL parameters IE used in the SETUP message?	SS_P or SS_N NOT (SS_P or SS_N)	M N/A	5.5.4.1.1	Yes_ No_ X_ S_
3.9.25	For an SVCCbased RCC connection is the AAL parameters IE coded with the following values? AAL Type = 5 (for AAL5) Forward Maximum CPCSSDU Size = 8192 octets Backward Maximum CPCSSDU Size = 8192 octets SSCS Type = 0 (Null SSCS)	SS_P or SS_N NOT (SS_P or SS_N)	M N/A	5.5.4.1.1, Table 5-2	Yes_ No_ X_ S_
3.9.26	For an SVCCbased RCC connection is the ATM traffic descriptor information element present in the SETUP message?	SS_P or SS_N NOT (SS_P or SS_N)	M N/A	5.5.4.1.2	Yes_ No_ X_ S_
3.9.27	When an LGN requests real-time or non-real-time VBR for an SVCC-based RCC, then by default does the SETUP use the following ATM traffic descriptor?: - PCR(CLP=0+1)=RCCPeakCellRate - SCR(CLP=0)=RCCSustainableCellRate - MBS(CLP=0)=RCCMaximumBurstSize - Tagging requested - Frame discard allowed	SS_P or SS_N NOT (SS_P or SS_N)	M N/A	5.5.4.1.2, Table 5-3	Yes_ No_ X_ S_
3.9.28	When an LGN requests CBR for an SVCC-based RCC, then by default does the SETUP use the following ATM traffic descriptor?: - PCR(CLP=0+1)=RCCPeakCellRate - Frame discard allowed	SS_P or SS_N NOT (SS_P or SS_N)	M N/A	5.5.4.1.2, Table 5-3	Yes_ No_ X_ S_

3.9.29	When an LGN requests ABR for an SVCC-based RCC, then by default does the SETUP use the following ATM traffic descriptor?: - PCR(CLP=0+1)= line rate <u>- MCR=0</u> - Frame discard allowed	(SS_P or SS_N) and OPT 8 (NOT (SS_P or SS_N)) or (NOT OPT 8)	M N/A	5.5.4.1.2, Table 5-3	Yes_ No_ X_ S_
3.9.30	When an LGN requests UBR for an SVCC-based RCC, then by default does the SETUP use the following ATM traffic descriptor?: - PCR(CLP=0+1)= line rate - Best effort indicator - Frame discard allowed	SS_P or SS_N NOT (SS_P or SS_N)	M N/A	5.5.4.1.2, Table 5-3	Yes_ No_ X_ S_
3.9.31	For an SVCCbased RCC connection is the Broadband bearer capability information element used in the SETUP message sent by the calling party?	SS_P or SS_N NOT (SS_P or SS_N)	M N/A	5.5.4.1.3	Yes_ No_ X_ S_
3.9.32	For an SVCC-based RCC is the Bearer class in the Broadband bearer capability IE coded as BCOB-X?	SS_P or SS_N NOT (SS_P or SS_N)	M N/A	5.5.4.1.3, Table 5-4	Yes_ No_ X_ S_
3.9.33	For an SVCC-based RCC is the Susceptibility to clipping in the Broadband bearer capability IE coded as 0 (not susceptible to clipping)?	SS_P or SS_N NOT (SS_P or SS_N)	M N/A	5.5.4.1.3, Table 5-4	Yes_ No_ X_ S_
3.9.34	For an SVCC-based RCC is the User plane connection configuration in the Broadband bearer capability IE coded as 0 for point-to-point?	SS_P or SS_N NOT (SS_P or SS_N)	M N/A	5.5.4.1.3, Table 5-4	Yes_ No_ X_ S_
3.9.35	For an SVCCbased RCC connection is the Broadband low layer IE used in the SETUP message?	SS_P or SS_N NOT (SS_P or SS_N)	M N/A	5.5.4.1.4	Yes_ No_ X_ S_
3.9.36	For an SVCCbased connection is the Broadband low layer IE encoded using the ATM Forum's allocated 24bit OUI with PID indicating PNNI RCC as coded in Table 55?	SS_P or SS_N NOT (SS_P or SS_N)	M N/A	5.5.4.1.4, Table 5-5	Yes_ No_ X_ S_
3.9.37	Is the QoS parameter IE used in the SETUP message sent to request the establishment of the RCC SVCC?	SS_P or SS_N NOT (SS_P or SS_N)	M N/A	5.5.4.1.5	Yes_ No_ X_ S_
3.9.38	For an SVCCbased RCC connection is the Extended QoS parameters IE used in the SETUP message sent by the calling party when the service category is nrtVBR, rtVBR, or CBR?	SS_P or SS_N NOT (SS_P or SS_N)	M N/A	5.5.4.1.6	Yes_ No_ X_ S_
3.9.39	For an SVCCbased RCC connection is the Called party number IE used in the SETUP message sent by the calling party?	SS_P or SS_N NOT (SS_P or SS_N)	M N/A	5.5.4.1.8	Yes_ No_ X_ S_
3.9.40	For an SVCCbased RCC connection are all ATM addresses used to setup the RCC, using the ATM Forum UNI ATM End System Address Format of 20 octets?	SS_P or SS_N NOT (SS_P or SS_N)	M N/A	5.5.4.1.8	Yes_ No_ X_ S_

3.9.41	For an SVCCbased RCC connection is the Calling party number IE used in the SETUP message sent by the calling party?	SS_P or SS_N NOT (SS_P or SS_N)	M N/A	5.5.4.1.9	Yes_ No_ X_ S_
3.9.42	For an SVCCbased RCC connection is the DTL IE included in the SETUP message sent by the calling party?	SS_P or SS_N NOT (SS_P or SS_N)	M N/A	5.5.4.1.11	Yes_ No_ X_ S_
3.9.43	For an SVCCbased RCC connection does the called party include the AAL parameters IE in the CONNECT message?	SS_P or SS_N NOT (SS_P or SS_N)	O N/A	5.5.4.2.1	Yes_ No_ X_ S_
3.9.44	For an SVCCbased RCC connection is the Broadband low layer IE included in the CONNECT message?	SS_P or SS_N NOT (SS_P or SS_N)	O N/A	5.5.4.2.2	Yes_ No_ X_ S_
3.9.45	For an SVCCbased RCC connection if the received Broadband low layer IE from the called party is different from the coding requested, is the call released by the calling LGN?	SS_P or SS_N NOT (SS_P or SS_N)	M N/A	5.5.4.2.2	Yes_ No_ X_ S_
3.9.46	For an SVCCbased RCC connection when the PNNI endpoint releases a RCC, is the cause IE encoded as follows? Coding standard = 0 IE instruction field = 0 Location = 0 cause value = 16	SS_P or SS_N NOT (SS_P or SS_N)	O.1 N/A	5.5.4.3, Table 5-9	Yes_ No_ X_ S_
3.9.47	For an SVCCbased RCC connection when the PNNI endpoint releases a RCC, is the cause IE encoded as follows? Coding standard = 0 IE instruction field = 0 Location = 0 cause value = 31	SS_P or SS_N NOT (SS_P or SS_N)	O.1 N/A	5.5.4.3, Table 5-9	Yes_ No_ X_ S_
3.9.48	For an SVCCbased RCC connection when the PNNI endpoint releases a RCC, is the cause IE encoded as follows? Coding standard = 3 IE instruction field = 0 Location = 0 cause value = 53	SS_P or SS_N NOT (SS_P or SS_N)	O.1 N/A	5.5.4.3, Table 5-9	Yes_ No_ X_ S_
3.9.49	If a lowestlevel node discovers that it is in the peer group of one of its neighbor's ancestors, is it prepared to communicate over an SVCC?	SS_N NOT SS_N	M N/A	5.5.5	Yes_ No_ X_ S_
3.9.50	If a lowestlevel node discovers that it is in the peer group of one of its neighbor's ancestors and its node ID is smaller than its peer, is it prepared to accept an SVCC?	SS_N NOT SS_N	M N/A	5.5.5	Yes_ No_ X_ S_
3.9.51	If a lowestlevel node discovers that it is in the peer group of one of its neighbor's ancestors and its node ID is greater than its peer, is it prepared to initiate an SVCC?	SS_N NOT SS_N	M N/A	5.5.5	Yes_ No_ X_ S_
3.9.52	If a lowestlevel node discovers that it is in the peer group of one of its neighbor's ancestors and an SVCC is established, does it use the procedures specified for operation over an SVCC?	SS_N NOT SS_N	M N/A	5.5.5	Yes_ No_ X_ S_

3.9.53	For an SVCC RCC is the called party address used, the ATM End System address advertised in the uplink that will be crossed by the SVCC?	SS_P or SS_N NOT (SS_P or SS_N)	M N/A	5.5.6.1	
3.9.54	For an SVCC RCC does the DTL in the SETUP message for an SVCC between LGN contain at the bottom of the stack two LGN IDs (LGN initiating the SVCC and LGN that is the target of the SVCC)?	SS_P or SS_N NOT (SS_P or SS_N)	M N/A	5.5.6.1	Yes_ No_ X_ S_
3.9.55	For an SVCC RCC SETUP message does the Logical Port ID of the last node in all lower DTLs, if any, specify a Logical Port ID that the border node has advertised in an uplink IG to the proper upnode?	SS_P NOT SS_P	M N/A	5.5.6.1	Yes_ No_ X_ S_
3.9.56	For an SVCC RCC SETUP message is this Logical Port ID not zero?	SS_P NOT SS_P	M N/A	5.5.6.1	Yes_ No_ X_ S_
3.9.57	When an uplink advertisement containing upnode X has reached ThisLGN and the node X is at a higher level than the level of the peer group of ThisLGN, does this LGN announce an uplink to X by originating an appropriate PTSE in This LGN's peer group?	SS_P NOT SS_P	M N/A	5.5.6.3 (A.1)	Yes_ No_ X_ S_
3.9.58	When an uplink advertisement containing upnode X has reached ThisLGN and the node X is at the same level as the level of the peer group of ThisLGN and it has an SVCC open to node X, does it do nothing?	SS_P NOT SS_P	M N/A	5.5.6.3 (A.2)	Yes_ No_ X_ S_
3.9.59	When an uplink advertisement containing upnode X has reached ThisLGN and the node X is at the same level as the level of the peer group of ThisLGN, ThisLGN does not have an SVCC open to node X, and ThisLGN has a smaller node ID, then does ThisLGN do nothing?	SS_P NOT SS_P	M N/A	5.5.6.3 (A.3)	Yes_ No_ X_ S_
3.9.60	When an uplink advertisement containing upnode X has reached ThisLGN and the node X is at the same or lower level than the level of the peer group of ThisLGN and not in the same common peer group, does it do nothing?	SS_P NOT SS_P	M N/A	5.5.6.3 (A.4)	Yes_ No_ X_ S_
3.9.61	When an uplink advertisement containing upnode X has reached ThisLGN and the node X is at the same level and in the same peer group as ThisLGN, ThisLGN does not have an SVCC open to node X, and ThisLGN has a larger node ID, then does ThisLGN establish an SVCC to node X?	SS_P NOT SS_P	M N/A	5.5.6.3 (A.5)	Yes_ No_ X_ S_
3.9.62	When ThisLGN determines that it must establish an SVCC to node X, does it wait for an interval of InitialLGNSVCTimeout (jittered) before opening an inter-LGN SVCC to node X?	SS_P or SS_N NOT (SS_P or SS_N)	M N/A	5.5.6.3 (A.5)	Yes_ No_ X_ S_
3.9.63	When ThisLGN's attempt to setup an SVCC-based RCC to node X fails, does it wait for an interval of RetryLGNSVC Timeout (jittered) before retrying the setup, if node X is still the upnode of an existing uplink to the same peer group as ThisLGN and there is still no SVCC open to node X?	SS_P or SS_N NOT (SS_P or SS_N)	M N/A	5.5.6.3 (A.5, E.1)	Yes_ No_ X_ S_
3.9.64	If ThisLGN detects the presences of two or more SVCs to the same neighboring LGN and if ThisLGN's node's ID is numerically larger than the neighboring LGN's node ID, does This LGN choose one SVCC to leave open and close all other SVCC(s) with cause number 16?	SS_P or SS_N NOT (SS_P or SS_N)	M N/A	5.5.6.3 (B.2)	Yes_ No_ X_ S_

3.9.65	If ThisPGL ceases to be PGL, does ThisPGL attempt to flush all PTSEs originated by ThisLGN by transmitting new instances with remaining lifetime ExpiredAge to all neighboring peers in states Exchanging, Loading, or Full?	SS_P NOT SS_	M N/A	5.5.6.3 (C.1)	Yes_ No_ X_ S_
3.9.66	If ThisPGL ceases to be PGL, does ThisLGN clear the SVCCs to all of its neighboring LGNs by sending RELEASE messages with cause IE indicating cause number 53?	SS_P NOT SS_P	M N/A	5.5.6.3	Yes_ No_ X_ S_
3.9.67	If an existing SVCC to a neighboring LGN is closed and if ThisLGN receives a RELEASE message with cause number 53, is the LinkDown event triggered in the SVCCbased RCC Hello FSM, the BadNeighbor event triggered in all associated LGN horizontal link Hello FSMs, and is RetryLGNSVCTimer started?	SS_P or SS_N NOT (SS_P or SS_N)	M N/A	5.5.6.3 (D.1), 5.6.3.2	Yes_ No_ X_ S_
3.9.68	If an SVCC fails with cause code indicating that the call was cleared due to a signalling error, the upnode X is still being advertised in one or more uplinks, no other SVCC exists to node X, and ThisLGN's node ID is numerically larger than that of upnode X, does ThisLGN immediately attempt to reestablish the SVCC-based RCC?	SS_P or SS_N NOT (SS_P or SS_N)	M N/A	5.5.6.3 (D.2)	Yes_ No_ X_ S_
3.9.69	If an SVCC fails with cause code that is not #53 and does not indicate a signalling error, the upnode X is still being advertised in one or more uplinks, no other SVCC exists to node X, and ThisLGN's node ID is numerically larger than that of upnode X, does ThisLGN start the RetryLGNSVCTimer with initial value RetryLGNSVCTimeout?	SS_P or SS_N NOT (SS_P or SS_N)	M N/A	5.5.6.3 (D.3)	Yes_ No_ X_ S_
COMMENTS					
O.1 At least one of these must be supported					

15.1.3.10 The Hello Protocol

Item	Protocol Feature	Conditions for status	Status Pred.	Spec. Ref.	Support
3.10.1	Is the Hello protocol running as long as the link is operational?		M	3.2.2	Yes_ No_ X_ S_
3.10.2	Does the node include the newest and oldest version supported fields in all packets?		M	5.6.1	Yes_ No_ X_ S_
3.10.3	Are all versions in the range advertised supported by the advertiser?		M	5.6.1	Yes_ No_ X_ S_
3.10.4	Does each physical link or VPC between two lowestlevel neighbor nodes have its own instance of the hello protocol?		M	5.6.2.1, 5.7	Yes_ No_ X_ S_
3.10.5	Is there only one instance per neighbor of local information (neighboring peer data structure) and associated neighbor peer state machine for the purposes of database synchronization and flooding of PTSEs?		M	5.6.2.1, 5.7	Yes_ No_ X_ S_
3.10.6	Is individual local information (hello data structure) maintained for each of this node's physical ports and for each logical port?		M	5.6.2.1.1	Yes_ No_ X_ S_
3.10.7	When the Remote Port ID is not known, is the value set to zero in transmitted Hello packets?		M	5.6.2.1.1	Yes_ No_ X_ S_
3.10.8	Is the Inactivity timer set to the value, InactivityFactor times the HelloInterval from the most recent Hello received from the neighbor?		M	5.6.2.1.1	Yes_ No_ X_ S_
3.10.9	Are the advertisements for physical links and VPCs suppressed, if the inside link is not in the 2WayInside state?		M	5.6.2.1.2	Yes_ No_ X_ S_
3.10.10	While in the Down state and a Link Up event is generated, is a Hello sent and the Attempt state entered?		M	Table 5-10 Hp1	Yes_ No_ X_ S_
3.10.11	While in any state other than the Down state and a Link Up event is generated, does the IUT do nothing?		M	Table 5-10 Hp0	Yes_ No_ X_ S_
3.10.12	While in the Down state and a 1Way Inside Received event is generated, does the IUT do nothing?		M	Table 5-10 Hp0	Yes_ No_ X_ S_
3.10.13	While in the Attempt state and a 1Way Inside Received event is generated, does the IUT start the Inactivity Timer, send a Hello, and enter the 1Way Inside state?		M	Table 5-10 Hp2	Yes_ No_ X_ S_
3.10.14	While in the 1Way Inside state and a 1Way Inside Received event is generated, is the Inactivity timer restarted?		M	Table 5-10 Hp12	Yes_ No_ X_ S_
3.10.15	While in the 2Way Inside state and a 1Way Inside Received event is generated, is the Inactivity timer restarted, a Hello sent, the Hello Timer restarted, and the 1Way Inside state entered?		M	Table 5-10 Hp10	Yes_ No_ X_ S_
3.10.16	While in the Attempt state and a 2Way Inside Received event is generated, is the Inactivity timer restarted, a Hello sent, the Hello Timer restarted, and 2Way Inside state entered?		M	Table 5-10 Hp3	Yes_ No_ X_ S_
3.10.17	While in the 1Way Inside state and a 2Way Inside Received event is generated, is the Inactivity Timer restarted and 2Way Inside state entered?		M	Table 5-10 Hp4	Yes_ No_ X_ S_
3.10.18	While in the 2Way Inside state and a 2Way Inside Received event is generated, is the Inactivity Timer restarted?		M	Table 5-10 Hp12	Yes_ No_ X_ S_
3.10.19	While in the Down state and a 1Way Outside Received event is generated, does the IUT do nothing?		M	Table 5-10 Hp0	Yes_ No_ X_ S_

3.10.20	While in the Attempt state and a 1Way Outside Received event is generated, does the IUT start the Inactivity Timer, send a Hello with nodal hierarchy information, restart the Hello Timer and enter the 1Way Outside state?	SS_B or SS_N NOT (SS_B or SS_N)	M N/A	Table 5-10 Hp5	Yes_ No_ X_ S_
3.10.21	While in the Attempt state and a 1Way Outside Received event is generated, does the IUT do nothing?	NOT SS_B SS_B	M N/A	Table 5-10 (Note 1)	Yes_ No_ X_ S_
3.10.22	While in the 1Way Outside state and a 1Way Outside Received event is generated, is the Inactivity Timer Restarted?	SS_B or SS_N NOT (SS_B or SS_N)	M N/A	Table 5-10 Hp12	Yes_ No_ X_ S_
3.10.23	While in the 2Way Outside state and a 1Way Outside Received event is generated, is the Inactivity Timer Restarted, the Received ULIA Sequence number and the Received Nodal Hierarchy Sequence number cleared, a Hello sent, the Hello Timer restarted and the 1Way Outside state entered?	SS_B or SS_N NOT (SS_B or SS_N)	M N/A	Table 5-10 Hp13	Yes_ No_ X_ S_
3.10.24	While in the Common Outside state and a 1Way Outside Received event is generated, is the Inactivity Timer Restarted, the Received ULIA Sequence number and the Received Nodal Hierarchy Sequence number cleared, a Hello sent, the Hello Timer restarted and the 1Way Outside state entered?	SS_B or SS_N NOT (SS_B or SS_N)	M N/A	Table 5-10 Hp14	Yes_ No_ X_ S_
3.10.25	While in the Attempt state and a 2Way Outside Received event is generated, does the IUT start the Inactivity Timer, send a Hello with nodal hierarchy information, restart the Hello Timer and enter the 2Way Outside state?	SS_B or SS_N NOT (SS_B or SS_N)	M N/A	Table 5-10 Hp5	Yes_ No_ X_ S_
3.10.26	While in the Attempt state and a 2Way Outside Received event is generated, does the IUT do nothing?	NOT SS_B SS_B	M N/A	Table 5-10 (Note 1)	Yes_ No_ X_ S_
3.10.27	While in the 1Way Outside state and a 2Way Outside Received event is generated, is the Inactivity Timer Restarted and the 2Way Outside state entered?	SS_B or SS_N NOT (SS_B or SS_N)	M N/A	Table 5-10 Hp12	Yes_ No_ X_ S_
3.10.28	While in the 2Way Outside state and a 2Way Outside Received event is generated, is the Inactivity Timer restarted?	SS_B or SS_N NOT (SS_B or SS_N)	M N/A	Table 5-10 Hp12	Yes_ No_ X_ S_
3.10.29	While in the Attempt state and a Common Hierarchy Received event is generated, is the Inactivity Timer restarted, a Hello sent with a nodal hierarchy list and ULIA, Hello Timer restarted, and the Common Outside state entered?	SS_B or SS_N NOT (SS_B or SS_N)	M N/A	Table 5-10 Hp6	Yes_ No_ X_ S_
3.10.30	While in the Attempt state and a Common Hierarchy Received event is generated, does the IUT do nothing?	NOT SS_B SS_B	M N/A	Table 5-10 (Note 1)	Yes_ No_ X_ S_
3.10.31	While in the 1Way Outside state and a Common Hierarchy Received event is generated, is the Inactivity Timer restarted?	SS_B or SS_N NOT (SS_B or SS_N)	M N/A	Table 5-10 Hp7	Yes_ No_ X_ S_
3.10.32	While in the 2Way Outside state and a Common Hierarchy Received event is generated, is the Inactivity Timer restarted?	SS_B or SS_N NOT (SS_B or SS_N)	M N/A	Table 5-10 Hp7	Yes_ No_ X_ S_

3.10.33	While in the Common Outside state and a Common Hierarchy Received event is generated, is the Inactivity Timer restarted?	SS_B or SS_N NOT (SS_B or SS_N)	M N/A	Table 5-10 Hp20	Yes_ No_ X_ S_
3.10.34	While in the Common Outside state and a Common Hierarchy Received event is generated and the ULIA sequence number does not match the received ULIA Sequence number in local information (hello data structure), is the new ULIA information reoriginated immediately (subject to PTSE holddown)?	SS_B or SS_N NOT (SS_B or SS_N)	M N/A	Table 5-10 Hp20	Yes_ No_ X_ S_
3.10.35	While in the Attempt state and a Hello Mismatch Received event is generated, does the IUT do nothing?		M	Table 5-10 Hp0	Yes_ No_ X_ S_
3.10.36	While in the 1Way Inside state and a Hello Mismatch Received event is generated, is the Inactivity Timer disabled, local information cleared, a Hello sent, Hello Timer restarted and the Attempt state entered?		M	Table 5-10 Hp8	Yes_ No_ X_ S_
3.10.37	While in the 2Way Inside state and a Hello Mismatch Received event is generated, is the Inactivity Timer disabled, local information cleared, a Hello sent, Hello Timer restarted and the Attempt state entered?		M	Table 5-10 Hp16	Yes_ No_ X_ S_
3.10.38	While in the 1Way Outside state and a Hello Mismatch Received event is generated, is the Inactivity Timer disabled, local information cleared, a Hello sent, Hello Timer restarted and the Attempt state entered?	SS_B or SS_N NOT (SS_B or SS_N)	M N/A	Table 5-10 Hp8	Yes_ No_ X_ S_
3.10.39	While in the 2Way Outside state and a Hello Mismatch Received event is generated, is the Inactivity Timer disabled, local information cleared, a Hello sent, Hello Timer restarted and the Attempt state entered?	SS_B or SS_N NOT (SS_B or SS_N)	M N/A	Table 5-10 Hp8	Yes_ No_ X_ S_
3.10.40	While in the Common Outside state and a Hello Mismatch Received event is generated, is the Inactivity Timer disabled, local information cleared, a Hello sent, Hello Timer restarted, the link removed from any PTSE originated by this node and the Attempt state entered?	SS_B or SS_N NOT (SS_B or SS_N)	M N/A	Table 5-10 Hp17	Yes_ No_ X_ S_
3.10.41	While in the Common Outside state and a Hierarchy Mismatch Received is generated, is the Inactivity Timer restarted, local information cleared, link removed from any PTSE originated by this node, and the 2Way Outside state entered?	SS_B or SS_N NOT (SS_B or SS_N)	M N/A	Table 5-10 Hp11	Yes_ No_ X_ S_
3.10.42	While in the Attempt state and the Hello Timer expires, does the IUT send a Hello and restart the Hello Timer?		M	Table 5-10 Hp15	Yes_ No_ X_ S_
3.10.43	While in the 1Way Inside state and the Hello Timer expires, does the IUT send a Hello and restart the Hello Timer?		M	Table 5-10 Hp15	Yes_ No_ X_ S_
3.10.44	While in the 2Way Inside state and the Hello Timer expires, does the IUT send a Hello and restart the Hello Timer?		M	Table 5-10 Hp15	Yes_ No_ X_ S_
3.10.45	While in the 1Way Outside state and the Hello Timer expires, does the IUT send a Hello and restart the Hello Timer?		M	Table 5-10 Hp15	Yes_ No_ X_ S_
3.10.46	While in the 2Way Outside state and the Hello Timer expires, does the IUT send a Hello and restart the Hello Timer?		M	Table 5-10 Hp15	Yes_ No_ X_ S_
3.10.47	While in the Common Outside state and the Hello Timer expires, does the IUT send a Hello and restart the Hello Timer?		M	Table 5-10 Hp15	Yes_ No_ X_ S_
3.10.48	While in the 1Way Inside state and Inactivity Timer expires, is the Inactivity Timer disabled, local information cleared, a Hello sent, Hello Timer restarted and the Attempt state entered?		M	Table 5-10 Hp8	Yes_ No_ X_ S_

3.10.49	While in the 2Way Inside state and the Inactivity Timer expires, is the Inactivity Timer disabled, local information cleared, a Hello sent, Hello Timer restarted and the Attempt state entered?		M	Table 5-10 Hp16	Yes_ No_ X_ S_
3.10.50	While in the 1Way Outside state and Inactivity Timer expires, is the Inactivity Timer disabled, local information cleared, a Hello sent, Hello Timer restarted and the Attempt state entered?	SS_B or SS_N NOT (SS_B or SS_N)	M N/A	Table 5-10 Hp8	Yes_ No_ X_ S_
3.10.51	While in the 2Way Outside state and Inactivity Timer expires, is the Inactivity Timer disabled, local information cleared, a Hello sent, Hello Timer restarted and the Attempt state entered?	SS_B or SS_N NOT (SS_B or SS_N)	M N/A	Table 5-10 Hp8	Yes_ No_ X_ S_
3.10.52	While in the Common Outside state and the Inactivity Timer expires, is the Inactivity Timer disabled, local information cleared, a Hello sent, Hello Timer restarted, the link removed from any PTSE originated by this node and the Attempt state entered?	SS_B or SS_N NOT (SS_B or SS_N)	M N/A	Table 5-10 Hp17	Yes_ No_ X_ S_
3.10.53	While in the Down state and a Link Down event is generated, does the IUT do nothing?		M	Table 5-10 Hp0	Yes_ No_ X_ S_
3.10.54	While in the Attempt state and a Link Down event is generated, is the Inactivity Timer disabled, the Hello Timer disabled, local information cleared, and the Down state entered?		M	Table 5-10 Hp9	Yes_ No_ X_ S_
3.10.55	While in the 1Way Inside state and a Link Down event is generated, is the Inactivity Timer disabled, the Hello Timer disabled, local information cleared, and the Down state entered?		M	Table 5-10 Hp9	Yes_ No_ X_ S_
3.10.56	While in the 2Way Inside state and a Link Down event is generated, is the Inactivity Timer disabled, the Hello Timer disabled, local information cleared, and the Down state entered?		M	Table 5-10 Hp18	Yes_ No_ X_ S_
3.10.57	While in the 1Way Outside state and a Link Down event is generated, is the Inactivity Timer disabled, the Hello Timer disabled, local information cleared, and the Down state entered?	SS_B or SS_N NOT (SS_B or SS_N)	M N/A	Table 5-10 Hp9	Yes_ No_ X_ S_
3.10.58	While in the 2Way Outside state and a Link Down event is generated, is the Inactivity Timer disabled, the Hello Timer disabled, local information cleared, and the Down state entered?	SS_B or SS_N NOT (SS_B or SS_N)	M N/A	Table 5-10 Hp9	Yes_ No_ X_ S_
3.10.59	While in the Common Outside state and a Link Down event is generated, is the Inactivity Timer disabled, the Hello Timer disabled, local information cleared, this link is removed from any PTSE originated by this node, and the Down state entered?	SS_B or SS_N NOT (SS_B or SS_N)	M N/A	Table 5-10 Hp19	Yes_ No_ X_ S_
3.10.60	When the Version field of the hello data structure is zero, are Hellos encoded using the newest version supported by this implementation?		M	5.6.2.2	Yes_ No_ X_ S_
3.10.61	When the Version field of the hello data structure is not zero, are Hellos encoded using the recorded version?		M	5.6.2.2	Yes_ No_ X_ S_
3.10.62	When in any state other than Down, does the IUT transmit Hellos periodically (i.e., every HelloInterval seconds)?		M	5.6.2.2	Yes_ No_ X_ S_

3.10.63	Is a Hello sent upon every state change subject to the Hold Down timer, except: 1Way Inside to 2Way Inside, 1Way Outside to 2Way Outside, 1Way Outside to Common Outside, 2Way Outside to Common Outside, and Common Outside to 2Way Outside?		M	5.6.2.2	Yes_ No_ X_ S_
3.10.64	Is a Hello sent on an outside link when a significant change occurs in the ULIA for this outside link, subject to the Hold Down timer?	SS_B or SS_N NOT (SS_B or SS_N)	M N/A	5.6.2.2	Yes_ No_ X_ S_
3.10.65	Is a Hello sent on an outside link when a change occurs in the node's nodal hierarchy list, subject to the HoldDown timer?	SS_B or SS_N NOT (SS_B or SS_N)	M N/A	5.6.2.2	Yes_ No_ X_ S_
3.10.66	Is a Hello sent on an outside link when a change occurs in the link aggregation token for this outside link, subject to the HoldDown timer?	SS_B or SS_N NOT (SS_B or SS_N)	M N/A	5.6.2.2	Yes_ No_ X_ S_
3.10.67	When multiple event triggered Hellos are deferred because of the HoldDown timer, does the IUT send only one hello which contains the most current information for all IGs when the HoldDown timer expires?		M	5.6.2.2	Yes_ No_ X_ S_
3.10.68	Is the Hello Timer restarted after an eventtriggered Hello is transmitted?		M	5.6.2.2	Yes_ No_ X_ S_
3.10.69	When in the Attempt state, do the Hellos have their remote node ID and remote port ID fields set to zero?		M	5.6.2.2	Yes_ No_ X_ S_
3.10.70	When in any state other than Down or Attempt state, do the Hellos have their remote node ID and remote port ID fields set to the neighbor node's node ID and port ID as stored locally (i.e. in the hello data structure)?		M	5.6.2.2	Yes_ No_ X_ S_
3.10.71	Is the nodal hierarchy list included in all Hellos sent while in any of the states: 1Way Outside, 2Way Outside, or Common Outside and not in any other state?	SS_B or SS_N NOT (SS_B or SS_N)	M N/A	5.6.2.2	Yes_ No_ X_ S_
3.10.72	Whenever a change occurs in the number or content of known higher levels, as expressed in the nodal hierarchy list, is the sequence number of the nodal hierarchy list incremented and an event triggered Hello sent, subject to Holddown?	SS_B or SS_N NOT (SS_B or SS_N)	M N/A	5.6.2.2	Yes_ No_ X_ S_
3.10.73	Whenever a change occurs in the node ID, peer group ID or ATM address at the lowest level, is the sequence number of the nodal hierarchy list incremented and an event triggered Hello sent, subject to Holddown?	SS_B or SS_N NOT (SS_B or SS_N)	M N/A	5.6.2.2	Yes_ No_ X_ S_
3.10.74	Is the sequence number of the first instance of the nodal hierarchy list sent to any neighbor greater than zero?	SS_B or SS_N NOT (SS_B or SS_N)	M N/A	5.6.2.2	Yes_ No_ X_ S_
3.10.75	Are all the known higher levels included in the nodal hierarchy list of each Hello transmitted?	SS_B or SS_N NOT (SS_B or SS_N)	M N/A	5.6.2.2	Yes_ No_ X_ S_

3.10.76	If no higher level is known, is an empty nodal hierarchy list included in the Hello?	SS_B or SS_N NOT (SS_B or SS_N)	M N/A	5.6.2.2	Yes_ No_ X_ S_
3.10.77	Is the ULIA information group included in all Hellos while in the states: 1Way Outside, 2Way Outside, or Common Outside?	SS_B or SS_N NOT (SS_B or SS_N)	M N/A	5.6.2.2, 5.6.2.2.1	Yes_ No_ X_ S_
3.10.78	Is the transmitted ULIA sequence number only incremented in a Hello packet, when a change to the transmitted ULIA contents is significant?	SS_B or SS_N NOT (SS_B or SS_N)	M N/A	5.6.2.2.1	Yes_ No_ X_ S_
3.10.79	Does any change in the received ULIA sequence number in a Hello packet, trigger an update to the corresponding uplink PTSE for the border node?	SS_B or SS_N NOT (SS_B or SS_N)	M N/A	5.6.2.2.1, 5.6.2.3.1	Yes_ No_ X_ S_
3.10.80	If no significant change occurred since the last transmitted ULIA, does the Hellos continue to contain the previous sequence number?	SS_B or SS_N NOT (SS_B or SS_N)	M N/A	5.6.2.2.1	Yes_ No_ X_ S_
3.10.81	When a significant change to some transmitted ULIA IG has occurred, are the most recent link state information for all transmitted ULIA IGs inserted in the transmitted Hello?	SS_B or SS_N NOT (SS_B or SS_N)	M N/A	5.6.2.2.1	Yes_ No_ X_ S_
3.10.82	If a Hello has a top level unknown TLV with the mandatory tag bit set, is the Hello packet discarded?		M	5.6.2.3	Yes_ No_ X_ S_
3.10.83	If the hello interval in the Hello packet is set to zero, is the Hello packet discarded?		M	5.6.2.3	Yes_ No_ X_ S_
3.10.84	If the port ID in the Hello packet is set to zero, is the Hello packet discarded?		M	5.6.2.3	Yes_ No_ X_ S_
3.10.85	If the remote node ID, remote PG ID and remote port ID in the local information (hello data structure) are not yet set, are they set to the received Hello's originating node ID, peer group ID, and port ID?		M	5.6.2.3	Yes_ No_ X_ S_
3.10.86	If the version field in the local information (hello link structure) is zero, is the lower of the received newest version supported and the local newest version supported calculated and recorded as the Version number?		M	5.6.2.3	Yes_ No_ X_ S_
3.10.87	If a new instance of the nodal hierarchy list, is received, is the nodal hierarchy list searched for the lowest level peer group that both nodes have in common?	SS_B or SS_N NOT (SS_B or SS_N)	M N/A	5.6.2.3	Yes_ No_ X_ S_
3.10.88	Are the neighbor's node ID, PG ID, and ATM End System address, considered to be the lowest component of the nodal hierarchy list?	SS_B or SS_N NOT (SS_B or SS_N)	M N/A	5.6.2.3	Yes_ No_ X_ S_
3.10.89	When a border node receives a Hello packet with a different ULIA sequence number than last received from a neighboring border node on an outside link, does it (re)originate the corresponding uplink PTSE that causes the derived aggregation token to change?	SS_B or SS_N NOT (SS_B or SS_N)	M N/A	5.6.2.3.1, 5.8.5.2.4, 5.10.3.1	Yes_ No_ X_ S_

3.10.90	Is the most recently received ULIA used to compose the uplink advertisement?	SS_B or SS_N NOT (SS_B or SS_N)	M N/A	5.6.2.3.1	Yes_ No_ X_ S_
---------	--	--	--------------	-----------	-------------------

15.1.3.11 SVCC-Based RCC Hello Protocol

Item	Protocol Feature	Conditions for status	Status Pred.	Spec. Ref.	Support
3.11.1	When using the SVCCBased RCC Hello Protocol, is the port ID field in the transmitted Hello message set to 0xFFFFFFFF?	SS_P or SS_N NOT (SS_P or SS_N)	M N/A	5.6.3.1	Yes_ No_ X_ S_
3.11.2	If the received port ID is different from 0xFFFFFFFF, is the event HelloMismatchReceived triggered?	SS_P or SS_N NOT (SS_P or SS_N)	M N/A	5.6.3.1	Yes_ No_ X_ S_
3.11.3	If the received PG ID is different from this node's PG ID, is the event HelloMismatchReceived triggered?	SS_P or SS_N NOT (SS_P or SS_N)	M N/A	5.6.3.1	Yes_ No_ X_ S_
3.11.4	If the node ID in the received Hello is not equal to the value in the corresponding uplink PTSE, is the event HelloMismatchReceived triggered?	SS_P or SS_N NOT (SS_P or SS_N)	M N/A	5.6.3.1	Yes_ No_ X_ S_
3.11.5	If the called party LGN receives a SETUP message from a node it does not recognize as a neighbor, does it accept the call?	SS_P or SS_N NOT (SS_P or SS_N)	M N/A	5.6.3.1	Yes_ No_ X_ S_
3.11.6	If the called party LGN receives a SETUP message from a node it does not recognize as a neighbor and is not at the lowest level, does it ignore any Hellos, until it receives an uplink PTSE indicating that node as a neighbor?	SS_P NOT SS_P	M N/A	5.6.3.1	Yes_ No_ X_ S_
3.11.7	When a HelloMismatchReceived, does the called party return to the Attempt state?	SS_P or SS_N NOT (SS_P or SS_N)	M N/A	5.6.3.1	Yes_ No_ X_ S_
3.11.8	When a HelloMismatchReceived, does the calling party release the SVCC with cause #16 and start the RetryLGNSVCTimer?	SS_P or SS_N NOT (SS_P or SS_N)	M N/A	5.6.3.1	Yes_ No_ X_ S_
3.11.9	When a HelloMismatchReceived, does the calling party release the SVCC with cause #16 and start the RetryLGNSVCTimer and is this situation logged and trapped to network management?	SS_P or SS_N NOT (SS_P or SS_N)	O N/A	5.6.3.1	Yes_ No_ X_ S_
3.11.10	Is failure of the SVCC when indicated from lower levels, treated as a LinkDown event and attempt to reestablish?	SS_P or SS_N NOT (SS_P or SS_N)	M N/A	5.6.3.1	Yes_ No_ X_ S_
3.11.11	If the IUT has a higher node ID than that of the neighboring peer, does it attempt to establish the SVCC?	SS_P or SS_N NOT (SS_P or SS_N)	M N/A	5.6.3.1.2	Yes_ No_ X_ S_
3.11.12	At the calling node, is the SVCIntegrityTimer set when the SVCC becomes active?	SS_P or SS_N NOT (SS_P or SS_N)	M N/A	5.6.3.1.2	Yes_ No_ X_ S_

3.11.13	At the calling node, is the SVCIntegrityTimer set when the state machine enters the Attempt state or the OneWay state and the timer is not running?	SS_P or SS_N NOT (SS_P or SS_N)	M N/A	5.6.3.1.2, 5.6.3.1	Yes_ No_ X_ S_
3.11.14	At the calling node, is the SVCIntegrityTimer disabled in the TwoWay and Down states?	SS_P or SS_N NOT (SS_P or SS_N)	M N/A	5.6.3.1.2	Yes_ No_ X_ S_
3.11.15	Does the expiration of the SVCIntegrityTimer cause a return to the Down state?	SS_P or SS_N NOT (SS_P or SS_N)	M N/A	5.6.3.1.2	Yes_ No_ X_ S_
3.11.16	At the calling node, upon entering the Down state, is the SVCC released and reestablished procedures followed?	SS_P or SS_N NOT (SS_P or SS_N)	M N/A	5.6.3.1.2, 5.6.3.1	Yes_ No_ X_ S_
3.11.17	Is the SVCIntegrityTimer started with the value SVCCallingIntegrityTime including jitter?	SS_P or SS_N NOT (SS_P or SS_N)	M N/A	5.6.3.1.2	Yes_ No_ X_ S_
3.11.18	At the called node, is the SVCIntegrityTimer set when a SETUP message is received?	SS_P or SS_N NOT (SS_P or SS_N)	M N/A	5.6.3.1.2	Yes_ No_ X_ S_
3.11.19	At the called node, is the SVCIntegrityTimer set when the state machine enters the Attempt or OneWay states and the timer is not running?	SS_P or SS_N NOT (SS_P or SS_N)	M N/A	5.6.3.1.2, 5.6.3.1	Yes_ No_ X_ S_
3.11.20	At the called node, is the SVCIntegrityTimer disabled in the TwoWay state?	SS_P or SS_N NOT (SS_P or SS_N)	M N/A	5.6.3.1.2	Yes_ No_ X_ S_
3.11.21	At the called node, upon entering the Down state, is the SVCC released?	SS_P or SS_N NOT (SS_P or SS_N)	M N/A	5.6.3.1.2, 5.6.3.1	Yes_ No_ X_ S_
3.11.22	If all PTSEs describing uplinks to the LGN neighbor have been deleted, does this node return to the Down State and start SVCIntegrityTimer?	SS_P NOT SS_P	M N/A	5.6.3.1.3	Yes_ No_ X_ S_

15.1.3.12 LGN Horizontal Link Hello Protocol

Item	Protocol Feature	Conditions for status	Status Pred.	Spec. Ref.	Support
3.12.1	Is the LGN horizontal link extension IG present in all Hellos transmitted to the neighboring peer LGN?	SS_P or SS_N NOT (SS_P or SS_N)	M N/A	5.6.3.2	Yes_ No_ X_ S_
3.12.2	Does the horizontal link extension IG contain an entry for each horizontal link to the neighboring peer node that is not in the Down state?	SS_P or SS_N NOT (SS_P or SS_N)	M N/A	5.6.3.2	Yes_ No_ X_ S_
3.12.3	For each horizontal link, are the aggregation token, local port ID and remote port ID included?	SS_P or SS_N NOT (SS_P or SS_N)	M N/A	5.6.3.2	Yes_ No_ X_ S_
3.12.4	Are the LGN horizontal links IG processed only in 2Way Inside and the corresponding neighboring peer state machine is in Full state?	SS_P or SS_N NOT (SS_P or SS_N)	M N/A	5.6.3.2	Yes_ No_ X_ S_
3.12.5	Is an LGN horizontal link advertised if and only if the LGN horizontal link hello state is 2Way?	SS_P or SS_N NOT (SS_P or SS_N)	M N/A	5.6.3.2, 5.6.3.2.2	Yes_ No_ X_ S_
3.12.6	When an uplink PTSE arrives with a new aggregation token value, is a logical port assigned and a state machine created in the Down state?	SS_P or SS_N NOT (SS_P or SS_N)	M N/A	5.6.3.2	Yes_ No_ X_ S_
3.12.7	When an uplink PTSE arrives with a new aggregation token value, is the AddInducingUplink event triggered?	SS_P or SS_N NOT (SS_P or SS_N)	M N/A	5.6.3.2	Yes_ No_ X_ S_
3.12.8	When an uplink PTSE arrives with a new aggregation token value and after the AddInducingUplink event is triggered, does the state machine transition to the Attempt State?	SS_P or SS_N NOT (SS_P or SS_N)	M N/A	5.6.3.2	Yes_ No_ X_ S_
3.12.9	Does the IUT after the event DropLastInducingUplink remove the aggregation token value and associated port ID from the Horizontal Link Extension information group?	SS_P or SS_N NOT (SS_P or SS_N)	M N/A	5.6.3.2	Yes_ No_ X_ S_
3.12.10	Does the IUT ignore a received aggregation token value in an LGN horizontal link extension IG when there is no corresponding local information (i.e., no state machine)?	SS_P or SS_N NOT (SS_P or SS_N)	M N/A	5.6.3.2	Yes_ No_ X_ S_
3.12.11	Does the absence of an aggregation token in the LGN Horizontal Link extension IG force the state machine associated with that aggregation token to the Attempt state?	SS_P or SS_N NOT (SS_P or SS_N)	M N/A	5.6.3.2	Yes_ No_ X_ S_
3.12.12	Upon the loss of an SVCCbased RCC for reasons other than RELEASE with cause 53, does each link remain up until the expiration of the Horizontal Link Inactivity timer or the last uplink is removed?	SS_P or SS_N NOT (SS_P or SS_N)	M N/A	5.6.3.2	Yes_ No_ X_ S_

3.12.13	If the SVCC is released with cause 53, is the event BadNeighbor triggered?	SS_P or SS_N NOT (SS_P or SS_N)	M N/A	5.6.3.2	Yes_ No_ X_ S_
3.12.14	Is local information (LGN horizontal link hello data structure) maintained for each horizontal link to a neighboring node?	SS_P or SS_N NOT (SS_P or SS_N)	M N/A	5.6.3.2.1	Yes_ No_ X_ S_
3.12.15	When the remote port ID is not known, is it set to zero in the Horizontal Link Extension IG?	SS_P or SS_N NOT (SS_P or SS_N)	M N/A	5.6.3.2.1	Yes_ No_ X_ S_
3.12.16	When in the Down state and the event AddInducingUplink is received, this inducing uplink added to the Inducing Uplink list and the Attempt state entered?	SS_P or SS_N NOT (SS_P or SS_N)	M N/A	Table 5-11 Hlhp10	Yes_ No_ X_ S_
3.12.17	When in the Attempt state and the event AddInducingUplink is received, this inducing uplink added to the Inducing Uplink list in the local information (LGN horizontal link hello data structure)?	SS_P or SS_N NOT (SS_P or SS_N)	M N/A	Table 5-11 Hlhp11	Yes_ No_ X_ S_
3.12.18	When in the 1Way state and the event AddInducingUplink is received, this inducing uplink added to the Inducing Uplink list in the local information (LGN horizontal link hello data structure)?	SS_P or SS_N NOT (SS_P or SS_N)	M N/A	Table 5-11 Hlhp11	Yes_ No_ X_ S_
3.12.19	When in the 2Way state and the event AddInducingUplink is received, this inducing uplink added to the Inducing Uplink list in the local information (LGN horizontal link hello data structure)?	SS_P or SS_N NOT (SS_P or SS_N)	M N/A	Table 5-11 Hlhp12	Yes_ No_ X_ S_
3.12.20	When in the 2Way state and the event AddInducingUplink is received, which causes a significant change in the topology state parameters, is a new instance of the horizontal link PTSE originated?	SS_P or SS_N NOT (SS_P or SS_N)	M N/A	Table 5-11 Hlhp12	Yes_ No_ X_ S_
3.12.21	When in the Down state and the event 1Way Received is received, does the IUT do nothing?	SS_P or SS_N NOT (SS_P or SS_N)	M N/A	Table 5-11 Hlhp0	Yes_ No_ X_ S_
3.12.22	When in the Down state and the event 2Way Received is received, does the IUT do nothing?	SS_P or SS_N NOT (SS_P or SS_N)	M N/A	Table 5-11 Hlhp0	Yes_ No_ X_ S_
3.12.23	When in the Down state and the event HelloMismatch Received is received, does the IUT do nothing?	SS_P or SS_N NOT (SS_P or SS_N)	M N/A	Table 5-11 Hlhp0	Yes_ No_ X_ S_
3.12.24	When in the Down state and the HorizontalLink Inactivity Timer expires, does the IUT do nothing?	SS_P or SS_N NOT (SS_P or SS_N)	M N/A	Table 5-11 Hlhp0	Yes_ No_ X_ S_
3.12.25	When in the Down state and the event BadNeighbor is received, does the IUT do nothing?	SS_P or SS_N NOT (SS_P or SS_N)	M N/A	Table 5-11 Hlhp0	Yes_ No_ X_ S_

3.12.26	When in the Attempt state and the event 1WayReceived is received, is the Port ID listed in the entry for the Aggregation Token saved in local information (LGN horizontal link hello data structure) and the 1Way state entered?	SS_P or SS_N NOT (SS_P or SS_N)	M N/A	Table 5-11 Hlhp1	Yes_ No_ X_ S_
3.12.27	When in the Attempt state and the event 2WayReceived is received, is the Port ID listed in the entry for the Aggregation Token saved in local information (LGN horizontal link hello data structure), an advertisement for this horizontal link included in a new instance of a horizontal link PTSE and the 2Way state entered?	SS_P or SS_N NOT (SS_P or SS_N)	M N/A	Table 5-11 Hlhp2	Yes_ No_ X_ S_
3.12.28	When in the Attempt state and the event HelloMismatch Received is received, does the IUT do nothing?	SS_P or SS_N NOT (SS_P or SS_N)	M N/A	Table 5-11 Hlhp0	Yes_ No_ X_ S_
3.12.29	When in the Attempt state and the HorizontalLink Inactivity Timer expires, does the IUT do nothing?	SS_P or SS_N NOT (SS_P or SS_N)	M N/A	Table 5-11 Hlhp0	Yes_ No_ X_ S_
3.12.30	When in the Attempt state and the event BadNeighbor is received, does the IUT do nothing?	SS_P or SS_N NOT (SS_P or SS_N)	M N/A	Table 5-11 Hlhp0	Yes_ No_ X_ S_
3.12.31	When in the Attempt state and the event DropInducingUplink is received, is the inducing uplink deleted from the local information (LGN horizontal link hello data structure)?	SS_P or SS_N NOT (SS_P or SS_N)	M N/A	Table 5-11 Hlhp13	Yes_ No_ X_ S_
3.12.32	When in the Attempt state and the event DropLastInducingUplink is received, is the inducing uplink deleted from the local information (LGN horizontal link hello data structure) and the Down state entered?	SS_P or SS_N NOT (SS_P or SS_N)	M N/A	Table 5-11 Hlhp13	Yes_ No_ X_ S_
3.12.33	When in the 1Way state and the event 1WayReceived is received, does the IUT do nothing?	SS_P or SS_N NOT (SS_P or SS_N)	M N/A	Table 5-11 Hlhp0	Yes_ No_ X_ S_
3.12.34	When in the 1Way state and the event 2WayReceived is received, is a new instance of a horizontal link PTSE originated by this node including an advertisement of this horizontal link and is the 2Way state entered?	SS_P or SS_N NOT (SS_P or SS_N)	M N/A	Table 5-11 Hlhp3	Yes_ No_ X_ S_
3.12.35	When in the 1Way state and the event HelloMismatch Received is received, is the local information for the remote Port ID cleared and the Attempt state entered?	SS_P or SS_N NOT (SS_P or SS_N)	M N/A	Table 5-11 Hlhp4	Yes_ No_ X_ S_
3.12.36	When in the 1Way state and the HorizontalLink Inactivity Timer expires, is the local information for the remote Port ID cleared and the Attempt state entered?	SS_P or SS_N NOT (SS_P or SS_N)	M N/A	Table 5-11 Hlhp4	Yes_ No_ X_ S_
3.12.37	When in the 1Way state and the event BadNeighbor is received, is the local information for the remote Port ID cleared and the Attempt state entered?	SS_P or SS_N NOT (SS_P or SS_N)	M N/A	Table 5-11 Hlhp4	Yes_ No_ X_ S_
3.12.38	When in the 1Way state and the event DropInducingUplink is received, is the inducing uplink deleted from the local information (LGN horizontal link hello data structure)?	SS_P or SS_N NOT (SS_P or SS_N)	M N/A	Table 5-11 Hlhp13	Yes_ No_ X_ S_

3.12.39	When in the 1Way state and the event DropLastInducingUplink is received, is the local information for the remote port ID cleared, the inducing uplink deleted from the local information (LGN horizontal link hello data structure), and the Down state entered?	SS_P or SS_N NOT (SS_P or SS_N)	M N/A	Table 5-11 Hlhp16	Yes_ No_ X_ S_
3.12.40	When in the 2Way state and the event 1WayReceived is received, is the horizontal link removed from the PTSE originated by this node and the 1Way state entered?	SS_P or SS_N NOT (SS_P or SS_N)	M N/A	Table 5-11 Hlhp6	Yes_ No_ X_ S_
3.12.41	When in the 2Way state and the event 2WayReceived is received, does the IUT do nothing?	SS_P or SS_N NOT (SS_P or SS_N)	M N/A	Table 5-11 Hlhp0	Yes_ No_ X_ S_
3.12.42	When in the 2Way state and the event HelloMismatch Received is received, is the local information for the remote Port ID cleared, the horizontal link removed from the PTSE originated by this node and the Attempt state entered?	SS_P or SS_N NOT (SS_P or SS_N)	M N/A	Table 5-11 Hlhp5	Yes_ No_ X_ S_
3.12.43	When in the 2Way state and the event HorizontalLink InactivityTimerExpired is received, is the local information for the remote Port ID cleared, the horizontal link removed from the PTSE originated by this node and the Attempt state entered?	SS_P or SS_N NOT (SS_P or SS_N)	M N/A	Table 5-11 Hlhp5	Yes_ No_ X_ S_
3.12.44	When in the 2Way state and the event BadNeighbor is received, is the local information for the remote Port ID cleared, the horizontal link removed from the PTSE originated by this node and the Attempt state entered?	SS_P or SS_N NOT (SS_P or SS_N)	M N/A	Table 5-11 Hlhp5	Yes_ No_ X_ S_
3.12.45	When in the 2Way state and the event DropInducingUplink is received, is the inducing uplink deleted from the local information (LGN horizontal link hello data structure) and the 2Way state entered?	SS_P or SS_N NOT (SS_P or SS_N)	M N/A	Table 5-11 Hlhp14	Yes_ No_ X_ S_
3.12.46	When in the 2Way state and the event DropInducingUplink is received and the deletion of this inducing uplink causes a significant change in the topology state parameters is a new instance of the horizontal link PTSE originated?	SS_P or SS_N NOT (SS_P or SS_N)	M N/A	Table 5-11 Hlhp14	Yes_ No_ X_ S_
3.12.47	When in the 2Way state and the event DropLastInducingUplink is received, is the remote Port ID cleared and the inducing uplink deleted from the local information (horizontal link hello data structure), originate a PTSE which does not include this horizontal link and the Down state entered?	SS_P or SS_N NOT (SS_P or SS_N)	M N/A	Table 5-11 Hlhp15	Yes_ No_ X_ S_

15.1.3.13 Overall Procedures

Item	Protocol Feature	Conditions for status	Status Pred.	Spec. Ref.	Support
3.13.1	Does a single Hello timer exist per SVCCbased RCC?	SS_P or SS_N NOT (SS_P or SS_N)	M N/A	5.6.3.3	Yes_ No_ X_ S_
3.13.2	Is the Hello timer reset any time a Hello is sent?	SS_P or SS_N NOT (SS_P or SS_N)	M N/A	5.6.3.3	Yes_ No_ X_ S_
3.13.3	Is the Horizontal Link Inactivity Timer <u>either started if it is not already active or otherwise restarted</u> reset each time a <u>non-empty</u> ³ LGN Horizontal Link Extension IG is processed?	SS_P or SS_N NOT (SS_P or SS_N)	M N/A	5.6.3.3	
3.13.4	Is an event-triggered Hello sent upon: - every state change in the SVCC-based RCC Hello state machine except for 1-Way Inside to 2-Way Inside, and - every state change in every LGN Horizontal Link Hello state machine associated with the neighboring peer LGN, except for 1-Way to 2-Way <u>- a state change in the corresponding Neighboring Peer state machine to the Full state?</u> ³	SS_P or SS_N NOT (SS_P or SS_N)	M N/A	5.6.3.3	Yes_ No_ X_ S_

15.1.3.14 Database Synchronization

Item	Protocol Feature	Conditions for status	Status Pred.	Spec. Ref.	Support
3.14.1	When a node first learns about the existence of a neighboring peer node in the same PG, does it initiate a database exchange process?		M	5.7	Yes_ No_ X_ S_
3.14.2	Does the IUT have at most one outstanding Database Summary packet at any one time per neighbor?		M	5.7, 5.7.5	Yes_ No_ X_ S_
3.14.3	Does the IUT have at most one outstanding PTSERequest packet during a Request Rxmt Interval per neighbor?		M	5.7, 5.7.7	Yes_ No_ X_ S_
3.14.4	When a node receives a Database Summary packet, does it examine its topology database for the presence of each PTSE described in the packet and if the PTSE is not in the topology database is the PTSE requested from a peer?		M	5.7, 3.2.3.4	Yes_ No_ X_ S_
3.14.5	If the PTSE is not in the topology database is the PTSE requested from another peer whose database summary indicates that it has the most recent version of the PTSE?		O	5.7	Yes_ No_ X_ S_
3.14.6	When a node receives a Database Summary packet, does it examine its topology database for the presence of each PTSE described in the packet and if the PTSE is more recent than the one in the topology database, is the PTSE requested from a peer?		M	5.7, 3.2.3.4	Yes_ No_ X_ S_
3.14.7	If the PTSE is more recent than the one in the topology database, is the PTSE requested from another peer whose database summary indicates that it has the most recent version of the PTSE?		O	5.7	Yes_ No_ X_ S_
3.14.8	When a link reaches the Hello state 2Way Inside, is the event AddPort triggered?		M	5.7	Yes_ No_ X_ S_
3.14.9	When a link falls out of the Hello state 2Way Inside, is the event DropPort triggered?		M	5.7	Yes_ No_ X_ S_
3.14.10	Does the database exchange commence when AddPort is first triggered?		M	5.7	Yes_ No_ X_ S_
3.14.11	When the DropPort event for the last link occurs, is the DropPortLast event generated?		M	5.7	Yes_ No_ X_ S_
3.14.12	Is all state information for the neighboring peer cleared, when the DropPortLast event occurs?		M	5.7	Yes_ No_ X_ S_
3.14.13	Are links between lowestlevel neighboring peers only advertised in PTSEs when the neighboring peer state machine is in Full state?		M	5.7	Yes_ No_ X_ S_
3.14.14	When the Hello state of the RCC reaches 2WayInside, is AddPort triggered and database exchange commenced?		M	5.7	Yes_ No_ X_ S_
3.14.15	When the Hello state of the RCC falls out of 2WayInside, is the DropPort event triggered and does the state machine go to NPDown state?		M	5.7	Yes_ No_ X_ S_
3.14.16	If this node is master, does it send the first Database Summary packet in the exchange?		M	5.7.1	Yes_ No_ X_ S_
3.14.17	Is the DSX Rxmt Timer stopped when the node receives a correct Database Summary packet?		M	5.7.1	Yes_ No_ X_ S_
3.14.18	Is the Request Rxmt Timer stopped when all of the PTSEs requested in the last PTSERequest packet have been received?		M	5.7.1	Yes_ No_ X_ S_

3.14.19	Does the event DSMismatch force the Negotiating state?		M	5.7.2	Yes_ No_ X_ S_
3.14.20	Does the event BadPTSERequest force the Negotiating state?		M	5.7.2	Yes_ No_ X_ S_
3.14.21	Does the event DropPort cause no state change, except when it is the last port to this neighbor (i.e., DropPortLast)?		M	5.7.2	Yes_ No_ X_ S_
3.14.22	Does the event DropPortLast force the NPDown state?		M	5.7.2	Yes_ No_ X_ S_
3.14.23	When in the NPDown state and an AddPort event occurs, does the node increment the DS sequence number, start sending Database Summary packets and enter the Negotiating state?		M	Table 5-12 Ds1	Yes_ No_ X_ S_
3.14.24	When in the NPDown state and an AddPort event occurs and this is the first time that an adjacency has been attempted, is the DS sequence number assigned a unique value?		M	Table 5-12 Ds1	Yes_ No_ X_ S_
3.14.25	When in the NPDown state and an AddPort event occurs and this is a lowestlevel node, which is connected by physical links or VPCs, is the port ID added to the Port ID list on the local information (neighboring peer data structure)?		M	Table 5-12 Ds1	Yes_ No_ X_ S_
3.14.26	When in the Negotiating state and an AddPort event occurs and this is a lowestlevel neighboring peer, which is connected by physical links or VPC, is the port ID added to the Port ID list as local information (neighboring peer data structure)?		M	Table 5-12 Ds7	Yes_ No_ X_ S_
3.14.27	When in the Exchanging state and an AddPort event occurs and this is a lowestlevel neighboring peer, which is connected by physical links or VPC, is the port ID added to the Port ID list as local information (neighboring peer data structure)?		M	Table 5-12 Ds7	Yes_ No_ X_ S_
3.14.28	When in the Loading state and an AddPort event occurs and this is a lowestlevel neighboring peer, which is connected by physical links or VPC, is the port ID added to the Port ID list as local information (neighboring peer data structure)?		M	Table 5-12 Ds7	Yes_ No_ X_ S_
3.14.29	When in the Full state and an AddPort event occurs and this is a lowestlevel neighboring peer, which is connected by physical links or VPC, is the port ID added to the Port ID list as local information (neighboring peer data structure) and a new instance of a PTSE to be originated?		M	Table 5-12 Ds8	Yes_ No_ X_ S_
3.14.30	When in the Negotiating state and the NegotiationDone event occurs, does the IUT begin sending Database Summary packets with information and enter the Exchanging state?		M	Table 5-12 Ds2	Yes_ No_ X_ S_
3.14.31	When in the Exchanging state and the ExchangeDone event occurs, is the DS Rxmt Timer stopped, start sending PTSE Request packets, and enter the Loading state?		M	Table 5-12 Ds3	Yes_ No_ X_ S_
3.14.32	When in the Exchanging state and the SynchDone event occurs, is the DS Rxmt Timer stopped and the Full state entered?		M	Table 5-12 Ds4	Yes_ No_ X_ S_
3.14.33	When in the Loading state and the LoadingDone event occurs, is the DS Rxmt Timer stopped and the Full state entered?		M	Table 5-12 Ds4	Yes_ No_ X_ S_

3.14.34	When in the Exchanging state and the event DS Mismatch is received, are timers: Peer Delayed Ack Timer, DS Rxmt Timer, and Request Rxmt Timer stopped if running; are the lists: Peer Retransmission, Peer Delayed Acks, and PTSE Request, and related timers cleared; is the DS sequence number incremented; is a Database Summary packet sent; is the DS Rxmt Timer started and the Negotiating state entered?		M	Table 5-12 Ds5	Yes_ No_ X_ S_
3.14.35	When in the Loading state and the event DS Mismatch is received, are timers: Peer Delayed Ack Timer, DS Rxmt Timer, and Request Rxmt Timer stopped if running; are the lists: Peer Retransmission, Peer Delayed Acks, and PTSE Request, and related timers cleared; is the DS sequence number incremented; is a Database Summary packet sent; is the DS Rxmt Timer started and the Negotiating state entered?		M	Table 5-12 Ds5	Yes_ No_ X_ S_
3.14.36	When in the Full state and the event DS Mismatch is received, are timers: Peer Delayed Ack Timer, DS Rxmt Timer, and Request Rxmt Timer stopped if running; are the lists: Peer Retransmission, Peer Delayed Acks, and PTSE Request, and related timers cleared; is the DS sequence number incremented; is a Database Summary packet sent; is the DS Rxmt Timer started and the Negotiating state entered?		M	Table 5-12 Ds6	Yes_ No_ X_ S_
3.14.37	When in the Full state and the event DS Mismatch is received and there is a PTSE advertising links to that neighbor, is that PTSE modified to remove the links and the PTSE reoriginated or flushed?		M	Table 5-12 Ds6	Yes_ No_ X_ S_
3.14.38	When in the Exchanging state and the event BadPTSE Request is received, are timers: Peer Delayed Ack Timer, DS Rxmt Timer, and Request Rxmt Timer stopped if running; are the lists: Peer Retransmission, Peer Delayed Acks, and PTSE Request, and related timers cleared; is the DS sequence number incremented; is a Database Summary packet sent; is the DS Rxmt Timer started and the Negotiating state entered?		M	Table 5-12 Ds5	Yes_ No_ X_ S_
3.14.39	When in the Loading state and the event BadPTSE Request is received, are timers: Peer Delayed Ack Timer, DS Rxmt Timer, and Request Rxmt Timer stopped if running; are the lists: Peer Retransmission, Peer Delayed Acks, and PTSE Request, and related timers cleared; is the DS sequence number incremented; is a Database Summary packet sent; is the DS Rxmt Timer started and the Negotiating state entered?		M	Table 5-12 Ds5	Yes_ No_ X_ S_
3.14.40	When in the Full state and the event BadPTSE Request is received, are timers: Peer Delayed Ack Timer, DS Rxmt Timer, and Request Rxmt Timer stopped if running; are the lists: Peer Retransmission, Peer Delayed Acks, and PTSE Request, and related timers cleared; is the DS sequence number incremented; is a Database Summary packet sent; is the DS Rxmt Timer started and the Negotiating state entered?		M	Table 5-12 Ds6	Yes_ No_ X_ S_
3.14.41	When in the Full state and the event BadPTSE Request is received and there is a PTSE advertising links to that neighbor, is that PTSE modified to remove the links and the PTSE reoriginated or flushed?		M	Table 5-12 Ds6	Yes_ No_ X_ S_

3.14.42	When in the Negotiating state and the event DropPort is received, is the link removed from the local information (neighboring peer data structure)?		M	Table 5-12 Ds9	Yes_ No_ X_ S_
3.14.43	When in the Negotiating state and the event DropPort is received and if this was the last active link to this neighbor, is the event DropPortLast generated?		M	Table 5-12 Ds9	Yes_ No_ X_ S_
3.14.44	When in the Exchanging state and the event DropPort is received, is the link removed from the local information (neighboring peer data structure)?		M	Table 5-12 Ds9	Yes_ No_ X_ S_
3.14.45	When in the Exchanging state and the event DropPort is received and if this was the last active link to this neighbor, is the event DropPortLast generated?		M	Table 5-12 Ds9	Yes_ No_ X_ S_
3.14.46	When in the Loading state and the event DropPort is received, is the link removed from the local information (neighboring peer data structure)?		M	Table 5-12 Ds9	Yes_ No_ X_ S_
3.14.47	When in the Loading state and the event DropPort is received and if this was the last active link to this neighbor, is the event DropPortLast generated?		M	Table 5-12 Ds9	Yes_ No_ X_ S_
3.14.48	When in the Full state and the event DropPort is received, is the link removed from the local information (neighboring peer data structure)?		M	Table 5-12 Ds9	Yes_ No_ X_ S_
3.14.49	When in the Full state and the event DropPort is received and if there is a PTSE advertising that link, is a new instance of the affected PTSE originated?		M	Table 5-12 Ds9	Yes_ No_ X_ S_
3.14.50	When in the Full state and the event DropPort is received and if this was the last active link to this neighbor, is the event DropPortLast generated?		M	Table 5-12 Ds9	Yes_ No_ X_ S_
3.14.51	When in any state other than NPDown and the event DropPort Last is received, are timers: Peer Delayed Ack Timer, DS Rxmt Timer, and Request Rxmt Timer stopped, if running; are the lists: Peer Retransmission, Peer Delayed Acks, and PTSE Request, and related timers cleared; and is the NPDown state entered?		M	Table 5-12 Ds10	Yes_ No_ X_ S_
3.14.52	When in the Negotiating state, does the node send empty Database Summary packets with the I, M and MS bits set?		M	5.7.5	Yes_ No_ X_ S_
3.14.53	Is the DS Rxmt Timer restarted after sending a Database Summary packet?		M	5.7.5	Yes_ No_ X_ S_
3.14.54	Are the Database Summary packets that are not acknowledged retransmitted every DSRxmtInterval seconds?		M	5.7.5	Yes_ No_ X_ S_
3.14.55	In Exchanging when the node is master, are Database Summary packets sent when the slave acknowledges the previous Database Summary packet?		M	5.7.5	Yes_ No_ X_ S_
3.14.56	In Exchanging when the node is master and this packet includes the last portions of the database summary to be sent to the slave, is the more (M) bit set to zero?		O	5.7.5	Yes_ No_ X_ S_
3.14.57	In Exchanging when the node is master and all of the database summary has already been sent to the slave, is the more (M) bit in the Database Summary packet set to zero?		M	5.7.5	Yes_ No_ X_ S_
3.14.58	In Exchanging when the node is master and this packet does not include the last portions of the database summary to be sent to the slave, is the more (M) bit set to one?		M	5.7.5	Yes_ No_ X_ S_
3.14.59	In Exchanging when the node is slave, are Database Summary packets sent only in response to Database Summary packets received?		M	5.7.5	Yes_ No_ X_ S_

3.14.60	In Exchanging when the node is slave and all of the database summary has already been previously sent to the master, is the more (M) bit in the Database Summary packet set to zero?		M	5.7.5	Yes_ No_ X_ S_
3.14.61	In Exchanging when the node is slave and this packet contains at least one item of the database summary to be sent to the master, is the more (M) bit set to one?		M	5.7.5	Yes_ No_ X_ S_
3.14.62	When the node is slave and in state Loading, is the last Database Summary packet (with I, M and MS bits set to zero) resent in response to duplicate Database Summary packets received from the master?		M	5.7.5	Yes_ No_ X_ S_
3.14.63	When the node is slave and in state Full, is the last Database Summary packet (with I, M and MS bits set to zero) resent in response to duplicate Database Summary packets received from the master?		M	5.7.5	Yes_ No_ X_ S_
3.14.64	When the node is slave and in state Loading, is the last packet sent empty with I, M and MS bits set to zero and the DS sequence number set to the value in the neighboring peer data structure?		M	5.7.5	Yes_ No_ X_ S_
3.14.65	When the node is slave and in state Full, is the last packet sent empty with I, M and MS bits set to zero and the DS sequence number set to the value in the neighboring peer data structure?		M	5.7.5	Yes_ No_ X_ S_
3.14.66	Is a Database Summary packet ignored if the neighboring peer state is NPDown?		M	5.7.6	Yes_ No_ X_ S_
3.14.67 ++	While in state Negotiating, if a packet is received that has I, M and MS are one, is empty, and the neighboring peer's node ID is larger than this node's own node ID, is the event NegotiationDone triggered?		M	5.7.6	Yes_ No_ X_ S_
3.14.68 ++	After generating the NegotiationDone (as in PICS 3.14.67), does the node stop the DS Rxmt Timer?		M	5.7.6	Yes_ No_ X_ S_
3.14.69 ++	After generating the NegotiationDone (as in PICS 3.14.67), does the node set the master/slave bit to slave (i.e., zero)?		M	5.7.6	Yes_ No_ X_ S_
3.14.70 ++	After generating the NegotiationDone (as in PICS 3.14.67), does the node set the initialize bit to zero?		M	5.7.6	Yes_ No_ X_ S_
3.14.71 ++	After generating the NegotiationDone (as in PICS 3.14.67), does the node set the DS sequence number to that specified by the master?		M	5.7.6	Yes_ No_ X_ S_
3.14.72 ++	After generating the NegotiationDone (as in PICS 3.14.67), does the node send a Database Summary packet to the master including the first portion of this node's database summary?		M	5.7.6	Yes_ No_ X_ S_
3.14.73	While in state Negotiating, if a packet is received that has I and MS are zero, the packet's DS sequence number equals this node's own DS sequence number, and the neighboring peer's node ID is smaller than this node's own node ID, is the event NegotiationDone triggered?		M	5.7.6	Yes_ No_ X_ S_
3.14.74	When master after generating the NegotiationDone (as in PICS 3.14.73), does the node stop the DS Rxmt Timer?		M	5.7.6	Yes_ No_ X_ S_
3.14.75	When master after generating the NegotiationDone (as in PICS 3.14.73), is the contents of the received Database Summary packet processed?		M	5.7.6	Yes_ No_ X_ S_
3.14.76	When master after generating the NegotiationDone (as in PICS 3.14.73), does the node increment the DS sequence number by one?		M	5.7.6, 5.7.1	Yes_ No_ X_ S_

3.14.77	When master after generating the NegotiationDone (as in PICS 3.14.73), does the node set the initialize bit to zero?		M	5.7.6	Yes_ No_ X_ S_
3.14.78	When master after generating the NegotiationDone (as in PICS 3.14.73), does the node send a Database Summary packet to the slave including the first portion of this node's database summary?		M	5.7.6	Yes_ No_ X_ S_
3.14.79	After sending a Database Summary packet to the slave, does the node restart the DS Rxmt Timer?		M	5.7.6	Yes_ No_ X_ S_
3.14.80	If the conditions of PICS 3.14.67 or PICS 3.14.73 are not met, does the IUT ignore the packet?		M	5.7.6	Yes_ No_ X_ S_
3.14.81	While in Exchanging, if the state of the MS bit is inconsistent with the master/slave state of the connection, is the event DSMismatch generated and processing of the packet stopped?		M	5.7.6	Yes_ No_ X_ S_
3.14.82	While in Exchanging, if I is set, is the event DSMismatch generated and processing of the packet stopped?		M	5.7.6	Yes_ No_ X_ S_
3.14.83	While in Exchanging and the node is master, if a packet is received that has the DS sequence number equal to this node's own DS sequence number, is the packet accepted?		M	5.7.6	Yes_ No_ X_ S_
3.14.84	While in Exchanging and the node is master, if a packet is received that has the DS sequence number equal to this node's own DS sequence number, is the DS Rxmt Timer stopped?		M	5.7.6	Yes_ No_ X_ S_
3.14.85	While in Exchanging and the node is master, if a packet is received that has the DS sequence number equal to this node's own DS sequence number, is the DS sequence number incremented by one?		M	5.7.6	Yes_ No_ X_ S_
3.14.86	While in Exchanging and the node is master, if a packet is received that has the DS sequence number equal to this node's own DS sequence number and the M bit is set to zero and this node has already sent its entire database and the PTSE Request List is not empty, is the event ExchangeDone generated?		M	5.7.6	Yes_ No_ X_ S_
3.14.87	While in Exchanging and the node is master, if a packet is received that has the DS sequence number equal to this node's own DS sequence number and the M bit is set to zero and this node has already sent its entire database and the PTSE Request List is empty, is the event SynchDone generated?		M	5.7.6	Yes_ No_ X_ S_
3.14.88	While in Exchanging and the node is master, if a packet is received that has the DS sequence number equal to this node's own DS sequence number and the M bit is set to zero and this node has not sent its entire database, is a new Database Summary packet sent and the DS Rxmt Timer restarted?		M	5.7.6	Yes_ No_ X_ S_
3.14.89	While in Exchanging and this node is master and a duplicate Database Summary packet is received, is the processing of this packet stopped?		M	5.7.6	Yes_ No_ X_ S_
3.14.90	While in Exchanging and this node is slave and the packet's DS sequence number is one more than this node's DS sequence number, is the packet accepted?		M	5.7.6	Yes_ No_ X_ S_

3.14.91	While in Exchanging and this node is slave and the packet's DS sequence number is one more than this node's DS sequence number, is the DS sequence number set to the DS sequence number appearing in the received packet?		M	5.7.6	Yes_ No_ X_ S_
3.14.92	While in Exchanging and this node is slave and the packet's DS sequence number is one more than this node's DS sequence number, is a Database Summary packet sent to the master?		M	5.7.6	Yes_ No_ X_ S_
3.14.93	While in Exchanging and the node is slave, if a packet is received that has the DS sequence number one more than this node's own DS sequence number and the just transmitted Data base Summary packet had the M bit is set to zero and the PTSE Request List is not empty, is the event ExchangeDone generated?		M	5.7.6	Yes_ No_ X_ S_
3.14.94	While in Exchanging and the node is slave, if a packet is received that has the DS sequence number one more than this node's own DS sequence number and the just transmitted Data base Summary packet had the M bit is set to zero and the PTSE Request List is empty, is the event SynchDone gener ated?		M	5.7.6	Yes_ No_ X_ S_
3.14.95 +++	While in Exchanging and this node is slave and a duplicate Database Summary packet is received , is the last Database Summary packet sent to the master retransmitted and process ing of the received Database Summary packet stopped?		M	5.7.6	Yes_ No_ X_ S_
3.14.96 +++	While in Exchanging and none of the PICS items 3.14.83 through 3.14.95 conditions are met, is the event DSMismatch generated?		M	5.7.6	Yes_ No_ X_ S_
3.14.97 ++++	If a PTSE summary is received which is newer than that in the database and is one of this node's selforiginated PTSE and this node still has a valid instance of the PTSE, is a newer ver sion of the PTSE with a larger sequence number reoriginated?		M	5.7.6	Yes_ No_ X_ S_
3.14.98	If a PTSE summary is received which is newer than that in the database and is one of this node's selforiginated PTSE and this node does not have a valid instance of the PTSE, is the PTSE flushed from the routing domain after installing it in the topology database with the remaining lifetime set to Expired Age?		M	5.7.6	Yes_ No_ X_ S_
3.14.99 ++++	If a PTSE summary is received which is newer than that in the database and with lifetime equal to ExpiredAge, is the header contents in the PTSE summary accepted as a new PTSE with empty contents?		M	5.7.6	Yes_ No_ X_ S_
3.14.100 ++++	If a PTSE summary is received which is newer than that in the database and that does not satisfy the conditions of PICS 3.14.97 and 3.14.99, is the PTSE put on the PTSE request list?		M	5.7.6	Yes_ No_ X_ S_
3.14.101	While in Loading if a Database Summary packet is received that is not a duplicate, is the event DSMismatch generated?		M	5.7.6	Yes_ No_ X_ S_
3.14.102	While in Loading if a Database Summary packet is received that has an inconsistent MSbit, is the event DSMismatch gen erated?		M	5.7.6	Yes_ No_ X_ S_
3.14.103	While in Loading if a Database Summary packet is received that has the initialize bit set, is the event DSMismatch gener ated?		M	5.7.6	Yes_ No_ X_ S_

3.14.104	While in Full if a Database Summary packet is received that is not a duplicate, is the event DSMismatch generated?		M	5.7.6	Yes_ No_ X_ S_
3.14.105	While in Full if a Database Summary packet is received that has an inconsistent MSbit, is the event DSMismatch generated?		M	5.7.6	Yes_ No_ X_ S_
3.14.106	While in Full if a Database Summary packet is received that has the initialize bit set, is the event DSMismatch generated?		M	5.7.6	Yes_ No_ X_ S_
3.14.107	Are PTSE request packets only sent in states Exchanging and Loading?		M	5.7.7	Yes_ No_ X_ S_
3.14.108	When a PTSE Request packet is sent, is the Request Rxmt Timer restarted?		M	5.7.7	Yes_ No_ X_ S_
3.14.109	When the proper PTSEs are received in response to requests, are those PTSE removed from the PTSE request list?		M	5.7.7	Yes_ No_ X_ S_
3.14.110	When all of the requested PTSEs have been received, is a new PTSE Request packet sent?		M	5.7.7	Yes_ No_ X_ S_
3.14.111	When the PTSE request list is empty and the state is Loading, is the event LoadingDone generated?		M	5.7.7	Yes_ No_ X_ S_
3.14.112	Are PTSE request packets accepted in the Exchanging state?		M	5.7.8	Yes_ No_ X_ S_
3.14.113	Are PTSE request packets accepted in the Loading state?		M	5.7.8	Yes_ No_ X_ S_
3.14.114	Are PTSE request packets accepted in the Full state?		M	5.7.8	Yes_ No_ X_ S_
3.14.115	Are PTSE Request packets ignored in the NPDown state?		M	5.7.8	Yes_ No_ X_ S_
3.14.116	Are PTSE Request packets ignored in the Negotiating state?		M	5.7.8	Yes_ No_ X_ S_
3.14.117	For each PTSE in the PTSE Request packet, if it is in the node's topology database, then is it transmitted to the neighbor?		M	5.7.8	Yes_ No_ X_ S_
3.14.118	Are the requested PTSEs not placed on the peer retransmission list?		M	5.7.8	Yes_ No_ X_ S_
3.14.119	If a PTSE cannot be found in the database, is the event BadPT SERequest generated?		M	5.7.8	Yes_ No_ X_ S_
<u>3.14.120</u> ³	<u>When in the Negotiating state and the event DS Rxmt Timer Expired is received, does the IUT send the previous Database Summary packet to the neighbor and restart the DS Rxmt timer?</u>		<u>M</u>	<u>Table 5-12 Ds11</u>	<u>Yes_ No_ X_ S_</u>
<u>3.14.121</u> ³	<u>When in the Exchanging state and the event DS Rxmt Timer Expired is received, does the IUT send the previous Database Summary packet to the neighbor and restart the DS Rxmt timer?</u>		<u>M</u>	<u>Table 5-12 Ds11</u>	<u>Yes_ No_ X_ S_</u>
<u>3.14.122</u> ³	<u>When in the Exchanging state and the event Request Rxmt Timer Expired is received, does the IUT send a PTSE Request packet containing one or more entries from the PTSE Request List to this neighboring peer, and/or optionally to any other neighboring peers, and restart the Request Rxmt timer?</u>		<u>M</u>	<u>Table 5-12 Ds12</u>	<u>Yes_ No_ X_ S_</u>
<u>3.14.123</u> ³	<u>When in the Loading state and the event Request Rxmt Timer Expired is received, does the IUT send a PTSE Request packet containing one or more entries from the PTSE Request List to this neighboring peer, and/or optionally to any other neighboring peers, and restart the Request Rxmt timer?</u>		<u>M</u>	<u>Table 5-12 Ds12</u>	<u>Yes_ No_ X_ S_</u>

3.14.124 ³	<u>When in the Exchanging state and the event PTSE Rxmt Timer Expired is received, does the IUT encapsulate in a PTSP those PTSEs that were last transmitted more than PTSE Retransmission Interval seconds ago and have not yet been acknowledged, transmit that PTSP to the neighboring peer, and restart all related PTSE Retransmission Timers?</u>		<u>M</u>	<u>Table 5-12</u> <u>Ds13</u>	<u>Yes No</u> <u>X S</u>
3.14.125 ³	<u>When in the Loading state and the event PTSE Rxmt Timer Expired is received, does the IUT encapsulate in a PTSP those PTSEs that were last transmitted more than PTSE Retransmission Interval seconds ago and have not yet been acknowledged, transmit that PTSP to the neighboring peer, and restart all related PTSE Retransmission Timers?</u>		<u>M</u>	<u>Table 5-12</u> <u>Ds13</u>	<u>Yes No</u> <u>X S</u>
3.14.126 ³	<u>When in the Full state and the event PTSE Rxmt Timer Expired is received, does the IUT encapsulate in a PTSP those PTSEs that were last transmitted more than PTSE Retransmission Interval seconds ago and have not yet been acknowledged, transmit that PTSP to the neighboring peer, and restart all related PTSE Retransmission Timers?</u>		<u>M</u>	<u>Table 5-12</u> <u>Ds13</u>	<u>Yes No</u> <u>X S</u>
3.14.127 ³	<u>When in the Exchanging state and the event Peer Delayed Ack Timer Expired is received, does the IUT send a PTSE Acknowledgment packet containing all PTSE identifying information items from the Peer Delayed Acks List to the neighboring peer, and delete the acknowledged PTSEs from the Peer Delayed Acks List?</u>		<u>M</u>	<u>Table 5-12</u> <u>Ds14</u>	<u>Yes No</u> <u>X S</u>
3.14.128 ³	<u>When in the Loading state and the event Peer Delayed Ack Timer Expired is received, does the IUT send a PTSE Acknowledgment packet containing all PTSE identifying information items from the Peer Delayed Acks List to the neighboring peer, and delete the acknowledged PTSEs from the Peer Delayed Acks List?</u>		<u>M</u>	<u>Table 5-12</u> <u>Ds14</u>	<u>Yes No</u> <u>X S</u>
3.14.129 ³	<u>When in the Full state and the event Peer Delayed Ack Timer Expired is received, does the IUT send a PTSE Acknowledgment packet containing all PTSE identifying information items from the Peer Delayed Acks List to the neighboring peer, and delete the acknowledged PTSEs from the Peer Delayed Acks List?</u>		<u>M</u>	<u>Table 5-12</u> <u>Ds14</u>	<u>Yes No</u> <u>X S</u>

15.1.3.15 Topology Description and Distribution

Item	Protocol Feature	Conditions for status	Status Pred.	Spec. Ref.	Support
3.15.1	Does the nodal information include: ATM End System address of the node? Leadership priority? Nodal information flags? Preferred peer group leader node ID?		M M M M	5.8.1.2, Table 5-35	Yes_ No_ X_ S_ Yes_ No_ Yes_ No_ Yes_ No_
3.15.2	When the IUT is acting as Peer Group Leader is the following information included in the nodal information Next higherlevel binding information?	SS_P NOT SS_P	M N/A	5.8.1.2, Table 5-35	Yes_ No_ X_ S_
3.15.3	Is the topology metric, CDV present for CBR and Real Time VBR service categories?		M	5.8.1.1.3.2, 5.8.5.2.5.6	Yes_ No_ X_ S_
3.15.4	Is the topology metric, MaxCTD present for CBR, Real Time VBR, and NonReal Time VBR service categories?		M	5.8.1.1.3.3, 5.8.5.2.5.5	Yes_ No_ X_ S_
3.15.5	Is the topology metric, Administrative weight present for all service categories?		M	5.8.1.1.3.4, 5.8.5.2.5.1	Yes_ No_ X_ S_
3.15.6	Is the topology attribute, CLR0 present for CBR, Real Time VBR, and NonReal Time VBR service categories?		M	5.8.1.1.3.5, 5.8.5.2.5.2	Yes_ No_ X_ S_
3.15.7	Is the topology attribute, CLR0+1 present for CBR, Real Time VBR, and NonReal Time VBR service categories?		M	5.8.1.1.3.5, 5.8.5.2.5.3	Yes_ No_ X_ S_
3.15.8	Is the topology attribute, MaxCR present for ABR and UBR service categories?		M	5.8.1.1.3.7, 5.8.5.2.5.7	Yes_ No_ X_ S_
3.15.9	Is the topology attribute, AvCR present for CBR, Real Time VBR, NonReal Time VBR and ABR service categories?		M	5.8.1.1.3.8	Yes_ No_ X_ S_
3.15.10	Is the Cell Rate Margin (CRM) topology attribute included with rtVBR or nrtVBR service categories?		O	5.8.1.1.3.9, 5.8.5.2.5.8	Yes_ No_ X_ S_
3.15.11	Is the Variance Factor (VF) topology attribute included with rtVBR or nrtVBR service categories?		O	5.8.1.1.3.10, 5.8.5.2.5.8	Yes_ No_ X_ S_
3.15.12	Is the Nontransit for PGL Election flag set to one when the node is operating in a topology database overload state?		M	5.8.1.2.3	Yes_ No_ X_ S_
3.15.13	Is the Nontransit for PGL Election flag set to zero when the node is operating normally?		M	5.8.1.2.3	Yes_ No_ X_ S_
3.15.14	Does the internal reachable ATM address information group contain: Port ID? Scope of advertisement? Address information length? Address information count? Pairs of prefix length and prefix? Information group for resource available information?		M M M M M O	5.8.1.3.1	Yes_ No_ X_ S_ Yes_ No_ Yes_ No_ Yes_ No_ Yes_ No_ Yes_ No_ Yes_ No_
3.15.15	Are <u>only-all non-zero</u> ports used <u>as-an-in</u> internal reachable address advertisements <u>not</u> advertised in any horizontal links or uplinks information groups in this node's PTSEs?		M	5.8.1.3.1	Yes_ No_ X_ S_
3.15.16	If Resource Availability information is specified with an internal reachable address, then is it specified for all service categories supported on that link in both directions?		M	5.8.1.3.1	Yes_ No_ X_ S_

3.15.17	Does the exterior reachable ATM address information group contain: Port ID? Scope of Advertisement? Address Information Length? Address Information Count? Pairs of prefix length and prefix? Information groups for resource availability information? Transit Network ID IG?		M M M M M M O O	5.8.1.3.2	Yes_ No_ X_ S_ Yes_ No_ Yes_ No_ Yes_ No_ Yes_ No_ Yes_ No_ Yes_ No_ Yes_ No_
3.15.18	Are only zero ports used as an exterior reachable address advertisement advertised in any horizontal links or uplinks information groups in this node's PTSEs?		M	5.8.1.3.2	Yes_ No_ X_ S_
3.15.19	If Resource Availability information is specified with an exterior reachable address, then is it specified for all service categories supported on that link in both directions?		M	5.8.1.3.2	Yes_ No_ X_ S_
3.15.20	Does a PTSP header contain the following items: Originating node ID? Originating node's peer group ID?		M M	5.8.2.1	X_ S_ Yes_ No_ Yes_ No_
3.15.21	Does a PTSE contain the following items: PTSE Identifier? PTSE Sequence Number? PTSE Checksum? PTSE Remaining Lifetime? PTSE Type?		M M M M M	5.8.2.1	X_ S_ Yes_ No_ Yes_ No_ Yes_ No_ Yes_ No_ Yes_ No_
3.15.22	When two instances of the same PTSE exist simultaneously and are found to be separate instances, does the more recent one take precedence based on the following in order: PTSE with larger PTSE sequence number, PTSE with PTSE Remaining Lifetime equal to ExpiredAge, PTSE with larger Checksum?		M	5.8.2.2.4	Yes_ No_ X_ S_
3.15.23	Is a PTSE Retransmission Timer associated with each PTSE in the PTSE Retransmission list for a particular neighbor?		M	5.8.3.1.3	Yes_ No_ X_ S_
3.15.24	Are all adjacencies in Exchanging, Loading or Full states used by the flooding procedures?		M	5.8.3.1	Yes_ No_ X_ S_
3.15.25	Are all adjacencies in Exchanging, Loading, or Full states capable of transmitting all types of PNNI routing packets?		M	5.8.3.1	Yes_ No_ X_ S_
3.15.26	Are all adjacencies in Exchanging, Loading, or Full states capable of receiving all types of PNNI routing packets?		M	5.8.3.1	Yes_ No_ X_ S_
3.15.27	During flooding, are PTSEs encapsulated in a PTSP?		M	3.2.3.5, 5.8.3.1	Yes_ No_ X_ S_
3.15.28	Does a node build and send PTSPs in response to a (self) origination of a new PTSE?		M	5.8.3.2	Yes_ No_ X_ S_
3.15.29	Does a node build and send PTSPs in response to a reorigination of a new instance of a (self originated) PTSE?		M	5.8.3.2	Yes_ No_ X_ S_
3.15.30	Does a node build and send PTSPs in response to installation into the database of a new instances of nonselforiginated PTSEs?		M	5.8.3.2	Yes_ No_ X_ S_
3.15.31	Does a node build and send PTSPs in response to expiration of the PTSE retransmission timer?		M	5.8.3.2	Yes_ No_ X_ S_
3.15.32	Does a node build and send PTSPs in response to a PTSE request?		M	5.8.3.2	Yes_ No_ X_ S_
3.15.33	Does a node build and send PTSPs in response to the expiration of the PTSE remaining lifetime?		M	5.8.3.2	Yes_ No_ X_ S_

3.15.34	Are all PTSEs which are bundled into a single PTSP originated from the same node?		M	5.8.3.2	Yes_ No_ X_ S_
3.15.35	Does a node build PTSPs which are less than or equal to the maximum packet size allowed on the link?		M	5.8.3.2	Yes_ No_ X_ S_
3.15.36	Does a node not violate the traffic contract for the link it is using?		M	5.8.3.2	Yes_ No_ X_ S_
3.15.37	If a node cannot send a PTSP immediately to stay with the bounds of the traffic contract, is the state saved until conditions permit the PTSP to be sent?		M	5.8.3.2	Yes_ No_ X_ S_
3.15.38	If the PTSE Remaining Lifetime on the received PTSE is different from expired age, is the PTSE checksum validated?		M	5.8.3.3	Yes_ No_ X_ S_
3.15.39	If the PTSE Checksum on the received PTSE is determined to be invalid, is the processing of the PTSE complete?		M	5.8.3.3	Yes_ No_ X_ S_
3.15.40	Is each PTSE on the PeerRetransmitList retransmitted every PTSERetransmissionInterval seconds?		M	5.8.3.4, 5.7.1, 3.2.3.5	Yes_ No_ X_ S_
3.15.41	Is the PTSE lifetime decremented by one from the current PTSE lifetime value in the database when the PTSE is (re)transmitted?		M	5.8.3.4	Yes_ No_ X_ S_
3.15.42	When the PeerDelayedAck Timer fires, are acknowledgement packets retransmitted that contain all the entries on the Peer Delayed Acks List, and the list cleared?		M	5.7.1, 5.8.3.5	Yes_ No_ X_ S_
3.15.43	Are acknowledgements, which have been transmitted, deleted from the Peer Delayed Acks list?		M	5.8.3.5	Yes_ No_ X_ S_
3.15.44	Can a node prematurely age only selforiginated PTSEs?		M	5.8.3.8	Yes_ No_ X_ S_
3.15.45	When a node wants to age prematurely a PTSE, does it set the PTSE's PTSE remaining Lifetime to ExpiredAge?		M	5.8.3.8	Yes_ No_ X_ S_
3.15.46	Any time the PTSE's remaining lifetime becomes ExpiredAge, does the IUT (i.e., flush): Delete the PTSE from all neighboring peers' Peer Retransmission Lists and Peer Delayed Ack Lists Initiate a flood of the PTSE without contents <u>and without recalculating the PTSE Checksum</u> ?		M	5.8.3.8, 5.8.2.2.1	Yes_ No_ X_ S_
3.15.47 ³	Is a PTSE removed from this node's topology state database only when: <u>1) the PTSE's PTSE remaining Lifetime is equal to Expired Age,</u> <u>2) the PTSE is not contained on any of the node's Peer Retransmission Lists,</u> <u>or the PTSE is not on any of the node's PeerDelayedAcks Lists,</u> <u>3) none of the node's neighboring peers are in states Exchanging or Loading,</u> <u>4) if the node is a logical group node, the peer group leader in the child peer group has either no instance of this PTSE in its view of the topology database, or an instance of the PTSE with Remaining Lifetime equal to ExpiredAge,</u> <u>5) If the PTSE is a remaining lifetime ExpiredAge PTSE instance used for proxy flushing, either the associated Proxy Flushing timer is not running, or this node is no longer peer group leader.?</u>		O.1	5.8.3.9, 5.8.2.2.1	Yes_ No_ X_ S_

3.15.48	Is a PTSE removed from this node's topology state database only when: <u>1) the PTSE's PTSE remaining Lifetime is equal to Expired Age,</u> <u>2) the PTSE is not contained on any of the node's Peer Retransmission Lists,</u> <u>3) none of the node's neighboring peers are in states Exchanging or Loading,</u> <u>4) if the node is a logical group node, the peer group leader in the child peer group has either no instance of this PTSE in its view of the topology database, or an instance of the PTSE with Remaining Lifetime equal to ExpiredAge,</u> <u>5) If the PTSE is a remaining lifetime ExpiredAge PTSE instance used for proxy flushing, either the associated Proxy Flushing timer is not running, or this node is no longer peer group leader.?</u>		O.1	5.8.3.9, 5.8.2.2.1	Yes_ No_ X_ S_
3.15.49	Does the node monitor the age of PTSEs collected in its topology database?		M	5.8.4	Yes_ No_ X_ S_
3.15.50	Are PTSEs, which have reached ExpiredAge, not used during route computation?		M	5.8.4	Yes_ No_ X_ S_
3.15.51	If the initial remaining lifetime is less than or equal to the elapsed time, is the remaining lifetime set to ExpiredAge?		M	5.8.4.1	Yes_ No_ X_ S_
3.15.52	Are PTSEs reoriginated after the PTSERefreshInterval?		M	5.8.4.2, 5.8.5	Yes_ No_ X_ S_
3.15.53	Is there a minimum time (i.e., MinPTSEInterval) between successive reoriginations of PTSEs?		M	5.8.5, 5.8.5.2	Yes_ No_ X_ S_
<u>3.15.54</u> ³	<u>Does the IUT group a set of internal prefixes into a single information group only if every optional information group included in the reachable address information group can be applied to all the prefixes in the set?</u>	<u>SS P</u> <u>NOT SS P</u>	<u>M</u> <u>N/A</u>	<u>5.8.1.3.1</u>	<u>Yes_ No_</u> <u>X_ S_</u>
<u>3.15.55</u> ³	<u>Does the IUT group a set of exterior prefixes into a single information group only if every optional information group included in the reachable address information group can be applied to all the prefixes in the set?</u>	<u>SS P</u> <u>NOT SS P</u>	<u>M</u> <u>N/A</u>	<u>5.8.1.3.2</u>	<u>Yes_ No_</u> <u>X_ S_</u>
<u>3.15.56</u> ³	<u>Does the IUT treat two instances of a PTSE that have the same PTSE sequence number and that both have PTSE Remaining Lifetime equal to ExpiredAge, to be the same PTSE instance?</u>		<u>M</u>	<u>5.8.2.2.4</u>	<u>Yes_ No_</u> <u>X_ S_</u>
<u>3.15.57</u> ³	<u>Does the IUT treat two instances of a PTSE that have the same PTSE sequence number and the same PTSE checksum, and that both have PTSE Remaining Lifetime other than ExpiredAge, to be the same PTSE instance?</u>		<u>M</u>	<u>5.8.2.2.4</u>	<u>Yes_ No_</u> <u>X_ S_</u>
O.1 At least one of these must be supported					

15.1.3.16 Advertising and Summarizing Reachable Address

Item	Protocol Feature	Conditions for status	Status Pred.	Spec. Ref.	Support
3.16.1	Are addresses only eligible for advertisement or summarization, if the scope is higher than or equal to that of the peer group?	SS_P NOT SS_P	M N/A	5.9.1	Yes_ No_ X_ S_
3.16.2	If suppression is configured for a given reachability advertisement, is advertisement of that address suppressed regardless of scope?	SS_P NOT SS_P	M N/A	5.9.2	Yes_ No_ X_ S_
3.16.3	Does the IUT support the ability to suppress summary addresses?	SS_P NOT SS_P	O N/A	5.9.2	Yes_ No_ X_ S_
3.16.4	When overlapping summary addresses and/or suppressed summary addresses are present, is the longest matching address used to determine how or if it is advertised?	SS_P NOT SS_P	M N/A	5.9.2	Yes_ No_ X_ S_

15.1.3.17 Hierarchy

Item	Protocol Feature	Conditions for status	Status Pred.	Spec. Ref.	Support
3.17.1	Is the PGL election continuously running?		M	3.2.4	Yes_ No_ X_ S_
3.17.2	If the parent peer group ID of the IUT is not configured does it advertise its Peer group leadership priority as zero?	SS_P NOT SS_P	M N/A	3.3.1	Yes_ No_ X_ S_
3.17.3	When a node is selecting its choice for PGL, does it select based on highest nonzero advertised PGL priority?		M	3.2.4, 5.10.1, 5.10.1.1, 5.10.1.1.6, 5.10.1.2.2	Yes_ No_ X_ S_
3.17.4	If there is a tie between the highest nonzero advertised PGL priorities, is the node with the larger node ID selected as the preferred PGL?		M	5.10.1.1	Yes_ No_ X_ S_
3.17.5	Does this node vote in a PGL election for its peer group?		M	5.10.1.1	Yes_ No_ X_ S_
3.17.6	Under normal conditions, do all nodes in a peer group participate in PGL election?		M	5.10.1.1	Yes_ No_ X_ S_
3.17.7	Does a node with Nontransit for PGL Election flag set in its nodal IG, not participate in PGL election?		M	5.10.1.1	Yes_ No_ X_ S_
3.17.8	Does this switch maintain local information (Peer Group Leader election data structure) which consists of: state, PreferredPeerGroupLeader, PreferredPGLLeadershipPriority, SearchPeer Timer, PGLInit Timer, Override Unanimity Timer, and ReElection Timer?		M	5.10.1.1.1	Yes_ No_ X_ S_
3.17.9	Does the node wait PGLInitTime before it selects and advertises its choice for PGL?		M	5.10.1.1.2	Yes_ No_ X_ S_
3.17.10	Is the PGL InitTimer started when the node has received the entire database from at least one neighbor?		M	5.10.1.1.4	Yes_ No_ X_ S_
3.17.11	When in Starting state and the event, Hello FSM Started occurs, is the SearchPeer Timer started and the Awaiting state entered?		M	Table 5-14 PGLE1	Yes_ No_ X_ S_
3.17.12	When in Awaiting state and the event, Peer Found occurs, is the SearchPeer Timer stopped and the AwaitingFull state entered?		M	Table 5-14 PGLE2	Yes_ No_ X_ S_
3.17.13	When in Awaiting state and the event, SearchPeer Timer Expired occurs, is the value of its PreferredPeerGgroupLeader (re)evaluated; are timers: OverrideUnanimity and ReElection stopped, if running; and the Calculating state entered?		M	Table 5-14 PGLE4	Yes_ No_ X_ S_
3.17.14	When in AwaitingFull state and the event, PeerFound, occurs, does nothing occur?		M	Table 5-14 PGLE0	Yes_ No_ X_ S_
3.17.15	When in AwaitingFull state and the event, Lost All Peers occurs, is the SearchPeer Timer restarted and is the Awaiting state entered?		M	Table 5-14 PGLE3	Yes_ No_ X_ S_

3.17.16	When in AwaitingFull state and the event, DB Received, occurs, is the PGLInit timer started; a PTSE originated with its leadership priority, the "I am leader" bit set to 0 and the Preferred peer group leader node ID set to 0; and the InitialDelay state entered?		M	Table 5-14 PGLE5	Yes_ No_ X_ S_
3.17.17	When in InitialDelay state and the event, PeerFound, occurs, does nothing occur?		M	Table 5-14 PGLE0	Yes_ No_ X_ S_
3.17.18	When in InitialDelay state and the event, Lost All Peers, occurs, does nothing occur?		M	Table 5-14 PGLE0	Yes_ No_ X_ S_
3.17.19	When in InitialDelay state and the event, DB Received, occurs, does nothing occur?		M	Table 5-14 PGLE0	Yes_ No_ X_ S_
3.17.20	When in InitialDelay state and the event, PGLInit Timer Expired, occurs, is the value of its PreferredPeerG groupLeader (re)evaluated; are timers: OverrideUnanimity and ReElection stopped, if running; and the Calculating state entered?		M	Table 5-14 PGLE4	Yes_ No_ X_ S_
3.17.21	When in Calculating state and the event, Peer Found occurs, does the IUT do nothing?		M	Table 5-14 PGLE0	Yes_ No_ X_ S_
3.17.22	When in Calculating state and the event, Lost All Peers, occurs, does the IUT do nothing?		M	Table 5-14 PGLE0	Yes_ No_ X_ S_
3.17.23	When in Calculating state and the event, DB Received, occurs, does the IUT do nothing?		M	Table 5-14 PGLE0	Yes_ No_ X_ S_
3.17.24	When in Calculating state and the event, Preferred PGL Not Self, occurs and the preferred Peer Group Leader is different from the previously advertised one, is a new instance of the Nodal Information PTSE originated with the new preferred Peer Group Leader ID with the "I am Leader" bit set to 0, and the OperNotPGL state entered?		M	Table 5-14 PGLE7	Yes_ No_ X_ S_
3.17.25	When in Calculating state and the event, Preferred PGL Self occurs, is a new instance of the Nodal Information PTSE originated with the preferred Peer Group Leader ID set to this node's ID and the "I am leader" bit set to 0; the OverrideUnanimity timer started; and the AwtUnanimity state entered?	SS_P NOT SS_P	M N/A	Table 5-14 PGLE9	Yes_ No_ X_ S_
3.17.26	When in OperNotPGL state and the event, Peer Found, occurs, does the IUT do nothing?		M	Table 5-15 PGLE0	Yes_ No_ X_ S_
3.17.27	When in OperNotPGL state and the event, Lost All Peers, occurs, does the IUT do nothing?		M	Table 5-15 PGLE0	Yes_ No_ X_ S_
3.17.28	When in OperNotPGL state and the event, DB Received, occurs, does the IUT do nothing?		M	Table 5-15 PGLE0	Yes_ No_ X_ S_
3.17.29	When in OperNotPGL state and the event, Change Preferred PGL, occurs, is the value of its PreferredPeerGgroupLeader (re)evaluated; are timers: OverrideUnanimity and ReElection stopped, if running; and the Calculating state entered?		M	Table 5-15 PGLE4	Yes_ No_ X_ S_
3.17.30	When in OperNotPGL state and the event, Lose Connectivity To PGL, occurs, is the Reelection timer started and the AwtRe Election state entered?		M	Table 5-15 PGLE10	Yes_ No_ X_ S_
3.17.31	When in OperPGL state and the event, Peer Found, occurs, does the IUT do nothing?	SS_P NOT SS_P	M N/A	Table 5-15 PGLE0	Yes_ No_ X_ S_
3.17.32	When in OperPGL state and the event, Lost All Peers, occurs, does the IUT do nothing?	SS_P NOT SS_P	M N/A	Table 5-15 PGLE0	Yes_ No_ X_ S_

3.17.33	When in OperPGL state and the event, DB Received, occurs, does the IUT do nothing?	SS_P NOT SS_P	M N/A	Table 5-15 PGLE0	Yes_ No_ X_ S_
3.17.34	When in OperPGL state and the event, Unanimity, occurs, does the IUT do nothing?	SS_P NOT SS_P	M N/A	Table 5-15 PGLE0	Yes_ No_ X_ S_
3.17.35	When in OperPGL state and the event, Two Third Reached, occurs, does the IUT do nothing?	SS_P NOT SS_P	M N/A	Table 5-15 PGLE0	Yes_ No_ X_ S_
3.17.36	When in OperPGL state and the event, Change Preferred PGL, occurs, is a new instance of the nodal Information PTSE originated with updated Preferred Peer Group Leader ID field, original leadership priority and the "I am leader" bit set to 0; deactivates its parent LGN; and the Calculating state entered?	SS_P NOT SS_P	M N/A	Table 5-15 PGLE6	Yes_ No_ X_ S_
3.17.37	When in AwtUnanimity state and the event, Peer Found, occurs, does the IUT do nothing?	SS_P NOT SS_P	M N/A	Table 5-15 PGLE0	Yes_ No_ X_ S_
3.17.38	When in AwtUnanimity state and the event, Lost All Peers, occurs, does the IUT do nothing?	SS_P NOT SS_P	M N/A	Table 5-15 PGLE0	Yes_ No_ X_ S_
3.17.39	When in AwtUnanimity state and the event, DB Received, occurs, does the IUT do nothing?	SS_P NOT SS_P	M N/A	Table 5-15 PGLE0	Yes_ No_ X_ S_
3.17.40	When in AwtUnanimity state and the event, Unanimity, occurs, is the node's leadership priority increased by GroupLeaderIncrement; is the OverrideUnanimity timer stopped, if running; is a new instance of the Nodal Information PTSE originated with the updated leadership priority and the "I am leader" bit set to 1 and higher level peer group included; and the Oper PGL state entered?	SS_P NOT SS_P	M N/A	Table 5-15 PGLE8	Yes_ No_ X_ S_
3.17.41	When in AwtUnanimity state and the event, Override Unanimity Success, occurs, is the node's leadership priority increased by GroupLeaderIncrement; is the OverrideUnanimity timer stopped, if running; is a new instance of the Nodal Information PTSE originated with the updated leadership priority and the "I am leader" bit set to 1 and higher level peer group included; and the OperPGL state entered?	SS_P NOT SS_P	M N/A	Table 5-15 PGLE8	Yes_ No_ X_ S_
3.17.42	When in AwtUnanimity state and the event, Override Unanimity Failure, occurs, is the HungElection state entered?	SS_P NOT SS_P	M N/A	Table 5-15 PGLE0	Yes_ No_ X_ S_
3.17.43	When in AwtUnanimity state and the event, Two Third Reached, occurs, does the IUT do nothing?	SS_P NOT SS_P	M N/A	Table 5-15 PGLE0	Yes_ No_ X_ S_
3.17.44	When in AwtUnanimity state and the event, Change Preferred PGL occurs, is the value of its PreferredPeerGgroupLeader (re)evaluated; are timers: OverrideUnanimity and ReElection stopped, if running; and the Calculating state entered?	SS_P NOT SS_P	M N/A	Table 5-15 PGLE4	Yes_ No_ X_ S_
3.17.45	When in HungElection state and the event, Peer Found, occurs, does the IUT do nothing?	SS_P NOT SS_P	M N/A	Table 5-15 PGLE0	Yes_ No_ X_ S_
3.17.46	When in HungElection state and the event, Lost All Peers, occurs, does the IUT do nothing?	SS_P NOT SS_P	M N/A	Table 5-15 PGLE0	Yes_ No_ X_ S_

3.17.47	When in HungElection state and the event, DB Received, occurs, does the IUT do nothing?	SS_P NOT SS_P	M N/A	Table 5-15 PGLE0	Yes_ No_ X_ S_
3.17.48	When in HungElection state and the event, Unanimity, occurs, is the node's leadership priority increased by GroupLeaderIncrement; is the OverrideUnanimity timer stopped, if running; is a new instance of the Nodal Information PTSE originated with the updated leadership priority and the "I am leader" bit set to 1 and higher level peer group included; and the OperPGL state entered?	SS_P NOT SS_P	M N/A	Table 5-15 PGLE8	Yes_ No_ X_ S_
3.17.49	When in HungElection state and the event, Two Third Reached, occurs, is the node's leadership priority increased by GroupLeaderIncrement; is the OverrideUnanimity timer stopped, if running; is a new instance of the Nodal Information PTSE originated with the updated leadership priority and the "I am leader" bit set to 1 and higher level peer group included; and the OperPGL state entered?	SS_P NOT SS_P	M N/A	Table 5-15 PGLE8	Yes_ No_ X_ S_
3.17.50	When in HungElection state and the event, Change Preferred PGL occurs, is the value of its PreferredPeerGgroupLeader (re)evaluated; are timers: OverrideUnanimity and ReElection stopped, if running; and the Calculating state entered?	SS_P NOT SS_P	M N/A	Table 5-15 PGLE4	Yes_ No_ X_ S_
3.17.51	When in AwtReElection state and the event, PeerFound, occurs, does nothing occur?		M	Table 5-15 PGLE0	Yes_ No_ X_ S_
3.17.52	When in AwtReElection state and the event, Lost All Peers, occurs, does nothing occur?		M	Table 5-15 PGLE0	Yes_ No_ X_ S_
3.17.53	When in AwtReElection state and the event, DB Received, occurs, does nothing occur?		M	Table 5-15 PGLE0	Yes_ No_ X_ S_
3.17.54	When in AwtReElection state and the event, Change Preferred PGL occurs, is the value of its PreferredPeerGgroupLeader (re)evaluated; are timers: OverrideUnanimity and ReElection stopped, if running; and the Calculating state entered?		M	Table 5-15 PGLE4	Yes_ No_ X_ S_
3.17.55	When in AwtReElection state and the event, Reestablish connectivity To PGL, occurs, is the ReElection Timer stopped and the OperNotPGL state entered?		M	Table 5-15 PGLE11	Yes_ No_ X_ S_
3.17.56	When in AwtReElection state and the event, ReElection Timer Expired occurs, is the value of its PreferredPeerGgroupLeader (re)evaluated; are timers: OverrideUnanimity and ReElection stopped, if running; and the Calculating state entered?		M	Table 5-15 PGLE4	Yes_ No_ X_ S_
3.17.57	At the beginning of the peer group leader election, does the node originate a PTSE that contains a nodal information group?		M	5.10.1.1.5	Yes_ No_ X_ S_
3.17.58	Is the preferred peer group ID field set to zero, while in states Awaiting, AwaitingFull, and InitialDelay and Nontransit for PGL Election flag set?		M	5.10.1.1.5	Yes_ No_ X_ S_
3.17.59	Is the "I am leader" bit set only while in state OperPGL?	SS_P NOT SS_P	M N/A	5.10.1.1.5	Yes_ No_ X_ S_
3.17.60	Does the node reevaluate the value of its PreferredPeerGroupLeader each time it receives and accepts a PTSE that contains a nodal information group?		M	5.10.1.1.6	Yes_ No_ X_ S_
3.17.61	When a node concludes that it is peer group leader, does it increment its advertised peer group leadership priority by GroupLeaderIncrement?	SS_P NOT SS_P	M N/A	3.2.4, 5.10.1.2.1	Yes_ No_ X_ S_

3.17.62	When an uplink advertisement is generated and injected into a peer group, does it contain metrics for both directions?	SS_B NOT SS_B	M N/A	5.10.2	Yes_ No_ X_ S_
3.17.63	When nodes at the ends of an outside link discover that the other node is in a different peer group, do they include Resource Availability information for the outbound direction in their Hello packets?	SS_B NOT SS_B	M N/A	5.10.2.1	Yes_ No_ X_ S_
3.17.64	Do PTSEs never flow up the hierarchy?		M	3.3.2, 5.10.4	Yes_ No_ X_ S_
3.17.65	Are upper level PTSEs sent into the peer group by the PGL?	SS_P NOT SS_P	M N/A	5.10.4	Yes_ No_ X_ S_
<u>3.17.66</u> ³	<u>When in Starting state and the event LGNEnabled occurs, is the SearchPeer Timer started and the Awaiting state entered?</u>		<u>M</u>	<u>Table 5-14 PGLE1</u>	<u>Yes_ No_ X_ S_</u>
<u>3.17.67</u> ³	<u>Does the node reevaluate the value of its PreferredPeerGroupLeader whenever connectivity to another node in the peer group is established or is lost?</u>		<u>M</u>	<u>5.10.1.1.6</u>	<u>Yes_ No_ X_ S_</u>
<u>3.17.68</u> ³	<u>When a logical group node is first enabled by the IUT, does the logical group node's topology database consist logically of those PTSEs contained in the underlying peer group leader's topology database that are at the level of the logical group node or at a higher level?</u>	<u>SS_P NOT SS_P</u>	<u>M N/A</u>	<u>5.10.4</u>	<u>Yes_ No_ X_ S_</u>
<u>3.17.69</u> ³	<u>Does the IUT when acting as the peer group leader begin proxy flushing procedures whenever it receives a PTSE:</u> <ul style="list-style-type: none"> • <u>that is received from a neighboring peer node,</u> • <u>that is encapsulated in a PTSP where the level of the PTSE's originator's logical node ID is higher (smaller in value) than the level of the peer group that the PGL belongs to, and</u> • <u>for which there is either no instance whatsoever in the peer group leader's view of the topology database, or the received PTSE is determined to be more recent than the peer group leader's database copy?</u> 	<u>SS_P NOT SS_P</u>	<u>M N/A</u>	<u>5.10.4.1</u>	<u>Yes_ No_ X_ S_</u>
<u>3.17.70</u> ³	<u>When proxy flushing a PTSE, if the remaining lifetime in the received PTSE is other than ExpiredAge, does the IUT set the value of TimeToFlush to MinTimeToFlush and start the Proxy Flushing timer with initial value TimeToFlush?</u>	<u>SS_P NOT SS_P</u>	<u>M N/A</u>	<u>5.10.4.1</u>	<u>Yes_ No_ X_ S_</u>
<u>3.17.71</u> ³	<u>When proxy flushing a PTSE, if the remaining lifetime in the received PTSE is equal to ExpiredAge, does the IUT start or restart the Proxy Flushing timer using the current value of TimeToFlush?</u>	<u>SS_P NOT SS_P</u>	<u>M N/A</u>	<u>5.10.4.1</u>	<u>Yes_ No_ X_ S_</u>
<u>3.17.72</u> ³	<u>When a PTSE instance is received at the level of an ancestor node and it is the same as or more recent than the ExpiredAge PTSE instance being used for proxy flushing in the peer group leader's view of the topology database, does the IUT disable the Proxy Flushing timer, if it is running?</u>	<u>SS_P NOT SS_P</u>	<u>M N/A</u>	<u>5.10.4.1</u>	<u>Yes_ No_ X_ S_</u>
<u>3.17.73</u> ³	<u>When the Proxy Flushing timer expires, if this node is still peer group leader, does the IUT set the TimeToFlush interval for the PTSE being proxy flushed to the lesser of double its previous value and MaxTimeToFlush?</u>	<u>SS_P NOT SS_P</u>	<u>M N/A</u>	<u>5.10.4.1</u>	<u>Yes_ No_ X_ S_</u>

<u>3.17.74</u> ³	<u>When the Proxy Flushing timer expires, if this node is still peer group leader and the lifetime ExpiredAge PTSE instance in the peer group leader's view of the topology database satisfies all conditions for removal, does the IUT remove the lifetime ExpiredAge PTSE instance from the peer group leader's view of the topology database, and, if the parent logical group node's view of the topology database contains an instance of the PTSE, install this instance in the peer group leader's view of the topology database and flood it to the rest of the peer group in the normal manner?</u>	<u>SS P</u> <u>NOT SS P</u>	<u>M</u> <u>N/A</u>	<u>5.10.4.1</u>	<u>Yes No</u> <u>X S</u>
<u>3.17.75</u> ³	<u>When the Proxy Flushing timer expires, if this node is still peer group leader and the lifetime ExpiredAge PTSE instance in the peer group leader's view of the topology database does not satisfy all conditions for removal, does the IUT restart the Proxy Flushing timer using the current value of TimeToFlush?</u>	<u>SS P</u> <u>NOT SS P</u>	<u>M</u> <u>N/A</u>	<u>5.10.4.1</u>	<u>Yes No</u> <u>X S</u>
<u>3.17.76</u> ³	<u>Does a higher level node running on this IUT flood a self-originated PTSE to the PGL of the peer group that it represents if the PTSE contains Nodal State Parameter information groups ?</u>	<u>SS P</u>	<u>O</u>	<u>5.10.4</u>	<u>Yes No</u> <u>X S</u>
<u>3.17.77</u> ³	<u>Does a higher level node running on this IUT flood a self-originated PTSE to the PGL of the peer group that it represents if the PTSE contains PAR Service information groups ?</u>	<u>SS P</u>	<u>O</u>	<u>5.10.4</u>	<u>Yes No</u> <u>X S</u>

15.1.3.18 Peer Group Partitions

Item	Protocol Feature	Conditions for status	Status Pred.	Spec. Ref.	Support
3.18.1	When a PGL of a partition aggregates or summarizes its partition, does it only use the link state information that pertains to its partition?	SS_P NOT SS_P	M N/A	5.11.3	Yes_ No_ X_ S_

15.1.3.19 Topology Database Overload

Item	Protocol Feature	Conditions for status	Status Pred.	Spec. Ref.	Support
3.19.1	Is this node able to store and advertise all state information describing itself?		M	5.12.1.1	Yes_ No_ X_ S_
3.19.2	If the node is not able to store and advertise all state information describing itself, does it halt?		M	5.12.1.1	Yes_ No_ X_ S_
3.19.3	Is this node able to store and advertise all topology state describing the links to its neighbors?		M	5.12.1.1	Yes_ No_ X_ S_
3.19.4	If the node is not able to store and advertise all topology state describing the links to its neighbors, does it not bring up links which it cannot store the associated state?		M	5.12.1.1	Yes_ No_ X_ S_
3.19.5	When in topology database overload state, does the node not bring up any outside link?		M	5.12.1.2	Yes_ No_ X_ S_
3.19.6	When in topology database overload state, does the node not act as a DTL originator?		M	5.12.1.2	Yes_ No_ X_ S_
3.19.7	When in topology database overload state, does the node set the NonTransit for PGL Election flag?		M	5.12.1.3	Yes_ No_ X_ S_
3.19.8	When in topology database overload state, does the node advertise zero as its Leadership Priority?		M	5.12.1.3, 5.10.1.1, 5.10.1.1.5	Yes_ No_ X_ S_
3.19.9	When in topology database overload state, does the node advertise zero as its Preferred PGL?		M	5.12.1.3, 5.10.1.1, 5.10.1.1.5	Yes_ No_ X_ S_
3.19.10	When in topology database overload state, does the node continue to send PTSE acknowledgements?		M	5.12.1.4	Yes_ No_ X_ S_
3.19.11	When in topology database overload state, does the node continue to originate and flood PTSEs describing its own state and that of any of its active links?		M	5.12.1.4	Yes_ No_ X_ S_
3.19.12	When in topology database overload state, does the node periodically (i.e., OverloadRetryTime) attempt to resynchronize with its neighbors?		M	5.12.1.5	Yes_ No_ X_ S_
3.19.13	If the node is able to return to normal, does it clear the NonTransit for PGL Election flag?		M	5.12.1.5	Yes_ No_ X_ S_

15.1.3.20 Path Selection

Item	Protocol Feature	Conditions for status	Status Pred.	Spec. Ref.	Support
3.20.1	If a node is unable to follow the specified DTL for a specific call request, does it refuse the call request?		M	3.7	Yes_ No_ X_ S_
3.20.2	If a node is unable to follow the specified DTL for a specific call request, does it crankback the call to the node that originated the DTL?		M	3.7	Yes_ No_ X_ S_
3.20.3	Is the path used to cross a lower level peer group consistent with the path selected by higher levels?	SS_B NOT SS_B	M O	3.7	Yes_ No_ X_ S_
3.20.4	For point to multipoint connections does the node select a path that the resulting connection is a tree?		M	5.13	Yes_ No_ X_ S_
3.20.5	If the node with the longest prefix is an ancestor, then is the destination considered unreachable?		M	5.13	Yes_ No_ X_ S_
3.20.6	When the node receives a SETUP or ADD PARTY message that does not include a Transit network selection IE with a DTL stack indicating that it is the last node in the path, but the only best match address prefixes of wide enough scope are summary addresses advertised by this node or one of its ancestors, is the call cleared with cause #3 "no route to destination"?		M	5.13, Annex B, 8.2.1.1	Yes_ No_ X_ S_
3.20.7	When a Transit network election information element is present in the SETUP or ADD PARTY message, is the call routed to a node that advertises reachability to the specified transit network?		M	5.13, 7.2.1, 7.2.2, 7.3	Yes_ No_ X_ S_
3.20.8	When a Connection scope information element is present in the SETUP or ADD PARTY message, does the DTL originator route the call to a node reachable within the indicated connection scope?		M	5.13, 7.2.1	Yes_ No_ X_ S_
3.20.9	When the called party number is a group address and no Connection scope information element is present in the SETUP or ADD PARTY message, does the DTL originator route the call to a node reachable within the default connection scope of "localNetwork"?		M	5.13, 7.2.1	Yes_ No_ X_ S_
3.20.10	When an entry border node selects a path to the called party number or designated transit network, does the node at the end of the selected path have connectivity to the target with advertised membership scope at least as high as the path scope?	SS_B NOT SS_B	M N/A	5.13, 7.2.2	Yes_ No_ X_ S_
3.20.11	Does the DTL terminator progress the call using connectivity to the transit network or called party number with advertised membership scope higher than or equal to the path scope?		M	5.13, 7.3	Yes_ No_ X_ S_
3.20.12	When this node is computing a path from DTL Originator across a PNNI routing domain, are uplinks only used if a corresponding horizontal link was advertised from an ancestor of this node?		M	5.13.1	Yes_ No_ X_ S_
3.20.13	For UBR connections is a link/node only included if the UBR service class is supported and the Maximum Cell Rate is not equal to zero?		M	5.13.3	Yes_ No_ X_ S_

3.20.14	For ABR connections is a link/node only included if the ABR service class is supported, the Maximum Cell Rate is not equal to zero, and the advertised Available Cell Rate for the ABR traffic class is greater than or equal to the Minimum Cell Rate specified by the connection?		M	5.13.5	Yes_ No_ X_ S_
---------	---	--	---	--------	-------------------

15.1.3.21 Packet Formats

Item	Protocol Feature	Conditions for status	Status Pred.	Spec. Ref.	Support
3.21.1	Are all reserved fields set to zero upon transmission?		M	5.14, 5.14.2.6	Yes_ No_ X_ S_
3.21.2	Are all reserved fields ignored upon reception?		M	5.14, 5.14.2.6	Yes_ No_ X_ S_
3.21.3	If a system receives a PTSE with a top level mandatory tagged information group that is otherwise unknown, does it: accept the PTSE, check the checksum, check the sequence number, and acknowledge, store, and forward the PTSE?		M	5.14.2.1	Yes_ No_ X_ S_
3.21.4	Are all phase 1 information groups recognized?		M	5.14.2.1	Yes_ No_ X_ S_
3.21.5	If an unknown information group is tagged nontransitive, then is the information group removed prior to summarization?	SS_P NOT SS_P	M N/A	5.14.2.3	Yes_ No_ X_ S_
3.21.6	If an unknown information group that is not a top level information group in the PTSE is tagged as summarizable and transitive, then is the information group preserved?	SS_P NOT SS_P	M N/A	5.14.2.3	Yes_ No_ X_ S_
3.21.7	If two or more advertisements which are being aggregated each carry an unknown information group of the same transitive type, but with different values, does the PGL preserve the information groups by advertising the same information group multiple times?	SS_P NOT SS_P	M N/A	5.14.2.3	Yes_ No_ X_ S_
3.21.8	Are all PNNI 1.0 information groups originated with their information group tag values set to optional, summarizable, nontransitive, except the Transit network ID information group and the Systems capabilities information group?		M	5.14.2.6	Yes_ No_ X_ S_
3.21.9	Is the Transit network ID information group originated with its information group tag values set to have the values optional, summarizable and transitive?		M	5.14.2.6	Yes_ No_ X_ S_
3.21.10	Do all PNNI routing packets begin with a common PNNI packet header containing: packet type, packet length, protocol version, newest version supported, oldest version supported, and a one octet reserved field?		M	5.14.4, Table 5-20	Yes_ No_ X_ S_
3.21.11	Do uplink advertisements made by border nodes and PGLs include an Uplink Information Attribute?		M	5.14.6, 3.3.4	Yes_ No_ X_ S_
3.21.12	Is a Resource Availability Information Group included for each service category supported?		M	5.14.6	Yes_ No_ X_ S_
3.21.13	Are all metrics and attributes for each input/output port pair included in the same nodal state parameters information group?		M	5.14.9.1.1	Yes_ No_ X_ S_
3.21.14	Are all metrics and attributes associated with each exterior reachable ATM address included in the same exterior reachable ATM address information group to which the reachable address appears?		M	5.14.9.1.4	Yes_ No_ X_ S_

3.21.15	Are all metrics and attributes associated with each horizontal link included in the same horizontal link information group?	SS_P or SS_N NOT (SS_P or SS_N)	M N/A	5.14.9.1.5	Yes_ No_ X_ S_
3.21.16	Are all metrics and attributes associated with each uplink included in the same uplink information group?	SS_B NOT SS_B	M N/A	5.14.9.1.6	Yes_ No_ X_ S_
3.21.17	Is the system capabilities field permitted in all PNNI packets?		M	5.14.3, Table 5-18	Yes_ No_ X_ S_
3.21.18	If a PTSE includes a restricted information group whose type does not match the PTSEType, is the information contained in such a group ignored for the sake of all state significant computations?		M	5.14.9.4	Yes_ No_ X_ S_
3.21.19	If a Nodal Info IG appears multiple times in a Nodal Info PTSE, is only the first thereof used for the sake of all state significant computations?		M	5.14.9.5.1 b)	Yes_ No_ X_ S_
3.21.20	If a Nodal Info IG does not appear in a Nodal Info PTSE, are all the PTSEs of the node disregarded for the sake of all state significant computations?		M	5.14.9.5.1 c)	Yes_ No_ X_ S_
3.21.21	If a Higher Level Binding IG appears inside of a Nodal Info PTSE with a cleared "I am PGL"bit, is it ignored for the sake of state significant computations?		M	5.14.9.5.2 a)	Yes_ No_ X_ S_
3.21.22	If a Higher Level Binding IG appears multiple times in a Nodal Info PTSE for a node with a set "I am PGL"bit, is only the first thereof used for the sake of all state significant computations?		M	5.14.9.5.2 b)	Yes_ No_ X_ S_
3.21.23	If a Nodal State parameters IG appears multiple times in a Nodal State PTSE for a node with a set "Nodal Representation"bit, is only the first thereof used for the sake of all state significant computations?		M	5.14.9.5.3 b)	Yes_ No_ X_ S_
3.21.24	If the default spoke does not appear for a node with a set "Nodal Representation" bit, are all spokes of this node ignored in state-significant computations unless exceptions are advertised for both directions, except for reachability computations?		M	5.14.9.5.3 c)	Yes_ No_ X_ S_
3.21.25	If a Nodal State parameters IG appears multiple times in multiple Nodal State PTSEs for a node with a set "Nodal Representation"bit, is only the first one appearing in the PTSE with the lowest PTSEId used for the sake of all state significant computations?		M	5.14.9.5.3 e)	Yes_ No_ X_ S_
3.21.26	If a node does not have the "Nodal Representation" bit set and the node exposes a Nodal State representation, is this representation ignored for the sake of all state significant computations?		M	5.14.9.5.3 a)	Yes_ No_ X_ S_
3.21.27	If a Horizontal Link IG appears multiple times in a Horizontal Link PTSE, is only the first one used for the sake of all state significant computations?		M	5.14.9.5.4 b)	Yes_ No_ X_ S_
3.21.28	If a Horizontal Link IG appears multiple times in multiple Horizontal Link PTSEs, is only the first one appearing in the PTSE with the lowest PTSEId used for the sake of all state significant computations?		M	5.14.9.5.4 e)	Yes_ No_ X_ S_
3.21.29	Is 3.21.27 and 3.21.28 true for uplinks?		M	5.14.9.5.5	Yes_ No_ X_ S_

3.21.30	If multiple ULIAs appear in a Uplink IG, is only the first one used for the sake of all state significant computations?		M	5.14.9.5.6	Yes_ No_ X_ S_
3.21.31	If an uplink IG does not have a ULIA associated with it, is the link ignored for route computation?		M	5.14.9.5.6	Yes_ No_ X_ S_
3.21.32	If a service category appears in multiple RAIGs within a horizontal, uplink, nodal state or ULIA IG, is only the first RAIG in which this service category appears applied for this service category in all state significant computations?		M	5.14.9.5.7	Yes_ No_ X_ S_
3.21.33	If no valid nodal information PTSE is present, are all the PTSEs of the node ignored for the sake of all state-significant computations?		M	5.14.9.6	Yes_ No_ X_ S_

15.1.3.22 Signalling

Item	Protocol Feature	Conditions for status	Status Pred.	Spec. Ref.	Support
3.22.1	If no VPCs are configured for use as logical links on the interface, is the default signalling channel on VPI=0?		M	4.3	Yes_ No_ X_ S_
3.22.2	If no VPCs are configured for use as logical links on an interface, does the default signalling channel control all the virtual paths on the interface?		M	4.3	Yes_ No_ X_ S_
3.22.3	Are virtual channels within a configured VPC controlled only by the associated signalling channel of that particular VPC?		M	4.3	Yes_ No_ X_ S_
3.22.4	When cranking back, does the alternate path avoid the blocked node(s) or link(s)?		M	4.5	Yes_ No_ X_ S_
3.22.5	Are all bits of the VPI or VCI subfields that are not allocated set to zero?		M	6.1.2.3	Yes_ No_ X_ S_

15.1.3.23 Messages functional definitions and contents

Item	Protocol Feature	Conditions for status	Status Pred.	Spec. Ref.	Support
3.23.1	For the purposes of message format and information element content and format are the procedures of ATM UNI Signalling Specification v4.1v4.0 and PNNI section 6.3 followed?		M	6.3	Yes_ No_ X_ S_
3.23.2	If a SETUP message is sent with an Endpoint reference information element, does the ALERTING message include the Endpoint reference information element?		M	6.3.1.1	Yes_ No_ X_ S_
3.23.3	If a SETUP message is sent with an Endpoint reference information element, does the CALL PROCEEDING message include the Endpoint reference information element?		M	6.3.1.2	Yes_ No_ X_ S_
3.23.4	If a SETUP message is sent with an Endpoint reference information element, does the CONNECT message include the Endpoint reference information element?		M	6.3.1.3	Yes_ No_ X_ S_
3.23.5	If the calling user requested an ABR traffic category connection, is the ATM traffic descriptor information element included in the CONNECT message?		M	6.3.1.3	Yes_ No_ X_ S_
3.23.6	Is the Cause information element included in the RELEASE COMPLETE message, when it is the first call clearing message?		M	6.3.1.5	Yes_ No_ X_ S_
3.23.7	Is the Connection identifier included in the SETUP message when using non-3 associated signalling procedures?		M	6.3.1.6	Yes_ No_ X_ S_
3.23.8	Are one or more Designated transit list information elements included in the SETUP or ADD PARTY message?		M	6.3.1.6, 6.3.4.1, 7.2.1	Yes_ No_ X_ S_
3.23.9	Are the Designated transit list information element(s) immediately preceded by a Broadband repeat indicator information element coded to indicate Lastin, First out stack?		M	6.3.1.6, 6.3.4.1, 7.2.1	Yes_ No_ X_ S_
3.23.10	If the calling user requested an ABR traffic category connection, is the ATM-ATC-3 setup parameters information element included in the SETUP message?		M	6.3.1.6, 6.5.2.3.6	Yes_ No_ X_ S_
3.23.11	Is a STATUS message sent in response to a STATUS ENQUIRY message?		M	6.3.1.7, 6.3.1.8	Yes_ No_ X_ S_
3.23.12	Are the following messages sent using the global call reference? RESTART RESTART ACKNOWLEDGE		M	6.3.3 6.3.3.1 6.3.3.2	Yes_ No_ X_ S_
3.23.13	Is the Endpoint reference value unique within a given call reference on a given link?		M	6.3.4.1	Yes_ No_ X_ S_
3.23.14	Is the Endpoint reference value in the ADD PARTY ACKNOWLEDGE message, the same value as in the ADD PARTY message being responded to?		M	6.3.4.2	Yes_ No_ X_ S_
3.23.15	Is the Endpoint reference value in the ADD PARTY REJECT message, the same value as in the ADD PARTY message being responded to?		M	6.3.4.4	Yes_ No_ X_ S_
3.23.16	When a DROP PARTY ACKNOWLEDGE message is sent as a result of an error condition, is the Cause information element included?		M	6.3.4.6	Yes_ No_ X_ S_

3.23.17	Does the Crankback information element always include the crankback cause code?		M	6.4.6.3, 8.2	Yes_ No_ X_ S_
<u>3.23.18</u> ³	<u>Is the User-user information element supported in the applicable signalling messages?</u>		<u>O</u>	<u>6.3.1.1,</u> <u>6.3.1.3,</u> <u>6.3.1.4,</u> <u>6.3.1.6,</u> <u>6.3.1.10,</u> <u>6.3.2.3,</u> <u>6.3.4.1,</u> <u>6.3.4.2,</u> <u>6.3.4.3,</u> <u>6.3.4.4,</u> <u>6.3.4.5,</u> <u>6.3.4.6</u>	<u>Yes_ No_</u> <u>X_ S_</u>

15.1.3.24 Call/Connection control procedures

Item	Protocol Feature	Conditions for status	Status Pred.	Spec. Ref.	Support
3.24.1	Does the IUT use VPI=0 and VCI=5 for nonassociated signalling as the default?		M	6.5	Yes_ No_ X_ S_
3.24.2	Does the IUT use VPI=X and VCI=5 for associated signalling?		M	6.5	Yes_ No_ X_ S_
3.24.3	For signalling is the assured mode of the AAL used?		M	6.5.1	Yes_ No_ X_ S_
3.24.4	Are all layer 3 messages sent to the signalling AAL using the AALDATAREQUEST primitive?		M	6.5.1	Yes_ No_ X_ S_
3.24.5	Is call establishment initiated by the preceding side by sending a SETUP message?		M	6.5.2.1	Yes_ No_ X_ S_
3.24.6	After sending the SETUP message does the preceding side start timer T303?		M	6.5.2.1	Yes_ No_ X_ S_
3.24.7	After sending the SETUP message does the preceding side enter the Call Present state?		M	6.5.2.1	Yes_ No_ X_ S_
3.24.8	Does the SETUP message contain a call reference?		M	6.5.2.1	Yes_ No_ X_ S_
3.24.9	Is the SETUP message only sent when resources for the call are available for the preceding side?		M	6.5.2.1	Yes_ No_ X_ S_
3.24.10	If resources are not available is the call cleared towards the calling user?		M	6.5.2.1	Yes_ No_ X_ S_
3.24.11	Does the SETUP message contain all the information required to process the call?		M	6.5.2.1	Yes_ No_ X_ S_
3.24.12	Does the SETUP message contain the called party address information in the Called Party number information element?		M	6.5.2.1	Yes_ No_ X_ S_
3.24.13	Does the SETUP message contain the called party subaddress information element as a supplement to the called party number information element?		O	6.5.2.1, Figure 6-8	Yes_ No_ X_ S_
3.24.14	Does the SETUP message contain the ATM traffic descriptor information element?		M	6.5.2.1, Figure 6-8	Yes_ No_ X_ S_
3.24.15	Does the SETUP message contain the Broadband bearer capability information element?		M	6.5.2.1, Figure 6-8	Yes_ No_ X_ S_
3.24.16 ³	Does the SETUP message contain the <u>at least one of the Quality of service parameter or Extended QoS parameters information elements</u> ?		M	6.5.2.1, Figure 6-8	Yes_ No_ X_ S_
3.24.17	When the SETUP message contains an ATM group address in the Called party number information element, is the call progressed to one of the members of the group within the connection scope indicated?		M	6.5.2.1	Yes_ No_ X_ S_
3.24.18	When the SETUP message contains an ATM group address in the Called party number information element and the Connection scope selection information element is not included in the SETUP message, is the default (i.e., localNetwork(1)) Connection scope selection assumed?		M	6.5.2.1	Yes_ No_ X_ S_
3.24.19	If no response to the SETUP message is received by the preceding side before the first expiration of timer T303, is the SETUP retransmitted and timer T303 restarted?		O	6.5.2.1	Yes_ No_ X_ S_

3.24.20	If the preceding side does not receive any response to the SETUP after final expiration of timer T303 does the preceding side enter the Null state?		M	6.5.2.1	Yes_ No_ X_ S_
3.24.21	If the preceding side does not receive any response to the SETUP after final expiration of timer T303 does the preceding side send a RELEASE COMPLETE message to the succeeding side with cause #102?		M	6.5.2.1	Yes_ No_ X_ S_
3.24.22	If the preceding side does not receive any response to the SETUP after final expiration of timer T303 does the preceding side initiate clearing without crankback towards the calling party with cause #102?		M	6.5.2.1	Yes_ No_ X_ S_
3.24.23	If the preceding side does not receive any response to the SETUP after final expiration of timer T303 does the preceding side notify call control of the call failure?		M	6.5.2.1	Yes_ No_ X_ S_
3.24.24	Does the succeeding side enter the Call Initiated state on receipt of a SETUP message?		M	6.5.2.1	Yes_ No_ X_ S_
3.24.25	Does the IUT support associated signalling (i.e., exclusively control the VCs in the VPC which carries the signalling VC)?		O	6.5.2.2	Yes_ No_ X_ S_
3.24.26	Does the IUT support non-associated signalling?		M	6.5.2.2	Yes_ No_ X_ S_
3.24.27	Are the associated signalling procedures only used when two PNNI network nodes are connected by a virtual path connection used as a logical link?	3.24.25	M	6.5.2.2	Yes_ No_ X_ S_
3.24.28	Absent other errors is the call rejected with cause #36 when a Connection identifier information element is received with the Vassociated signalling field coded with a value not supported by this network node?		M	6.5.2.2	Yes_ No_ X_ S_
3.24.29 ³	For associated signalling when the preceding side having a lower lowest level node ID than succeeding side requests a virtual channel in the SETUP, does it indicate Exclusive VPCI; any VCI?	3.24.25	M	6.5.2.2.1	Yes_ No_ X_ S_
3.24.30	For associated signalling if the received Connection identifier information element indicated Exclusive VPCI; any VCI and no VCI is available, is a RELEASE COMPLETE message with cause #45 and with a crankback information element with crankback cause #45 sent?	3.24.25	M	6.5.2.2.1	Yes_ No_ X_ S_
3.24.31 ³	For associated signalling when the preceding side having higher lowest level node ID than succeeding side requests a virtual channel in the SETUP, does it indicate Exclusive VPCI; exclusive VCI?	3.24.25	M	6.5.2.2.1	Yes_ No_ X_ S_
3.24.32	For associated signalling if the received Connection identifier information element indicated Exclusive VPCI; exclusive VCI and the indicated VCI is not available, is a RELEASE COMPLETE message with cause #35 and with a crankback information element with crankback cause #35 sent?	3.24.25	M	6.5.2.2.1	Yes_ No_ X_ S_
3.24.33 ³	For nonassociated signalling when the preceding side having lower lowest level node ID than succeeding side requests a virtual channel in the SETUP does it indicate Exclusive VPCI; any VCI?		O.1	6.5.2.2.2.1	Yes_ No_ X_ S_

3.24.34	For nonassociated signalling if the received Connection identifier information element indicated Exclusive VPCI; any VCI and no VCI is available, is a RELEASE COMPLETE message with cause #45 and with a crankback information element with crankback cause #45 sent?		M	6.5.2.2.2.1	Yes_ No_ X_ S_
3.24.35 ³	For nonassociated signalling when the preceding side having higher lowest level node ID than succeeding side requests a virtual channel in the SETUP does it indicate Exclusive VPCI; exclusive VCI?		M	6.5.2.2.2.1	Yes_ No_ X_ S_
3.24.36	For nonassociated signalling if the received Connection identifier information element indicated Exclusive VPCI; exclusive VCI and the indicated VCI is not available, is a RELEASE COMPLETE message with cause #35 and with a crankback information element with crankback cause #35 sent?		M	6.5.2.2.2.1	Yes_ No_ X_ S_
3.24.37	For nonassociated signalling if the received Connection identifier information element indicated an Exclusive VPCI and it is not available, is a RELEASE COMPLETE message with cause #35 and with a crankback information element with crankback cause #35 sent?		M	6.5.2.2.2.1	Yes_ No_ X_ S_
3.24.38 ³	For nonassociated signalling when the preceding side having lower lowest level node ID than succeeding side requests a virtual channel in the SETUP does it not include the connection identifier information element?		O.1	6.5.2.2.2.1	Yes_ No_ X_ S_
3.24.39	For nonassociated signalling if the SETUP did not contain a connection identifier and no VCI can be allocated in any VPCI, is a RELEASE COMPLETE message with cause #45 and with a crankback information element with crankback cause #45 sent?		M	6.5.2.2.2.1	Yes_ No_ X_ S_
3.24.40	Does the IUT understand the relationship between the VPCI used in the signalling protocol and the actual VPI used for the user information flow?		M	6.5.2.2.3	Yes_ No_ X_ S_
3.24.41	Does each nonassociated signalling virtual channel control only a single interface and the VPCI and VPI have the same numerical value?		M	6.5.2.2.3	Yes_ No_ X_ S_
3.24.42	If the service category is not available, is crankback initiated with cause and crankback cause code #57, #58 or #65?		M	6.5.2.3.1	Yes_ No_ X_ S_
3.24.43	If the combination of Broadband bearer capability, ATM traffic descriptor, End-to-end transit delay, and Extended QoS parameters information elements contain a non supported set of parameters, is a RELEASE COMPLETE message with cause #73 and crankback cause #73 sent?		M	6.5.2.3.2	Yes_ No_ X_ S_
3.24.44	If the succeeding side is not able to provide the indicated ATM traffic parameters, does it send a RELEASE COMPLETE message with cause and crankback cause #37?		M	6.5.2.3.3	Yes_ No_ X_ S_
3.24.45	If both the Minimum acceptable ATM traffic descriptor and the Alternative ATM traffic descriptor information elements are present in a SETUP message, is the connection request rejected with cause #73 and no crankback?		M	6.5.2.3.4	Yes_ No_ X_ S_
3.24.46	If the Alternative ATM traffic descriptor information element is not coded as one of the allowed combinations, is the information element treated as a non mandatory information element with content error?		M	6.5.2.3.4	Yes_ No_ X_ S_

3.24.47	If the Minimum ATM traffic descriptor information element is not coded as one of the allowed combinations, is the information element treated as a nonmandatory information element with content error?		M	6.5.2.3.4	Yes_ No_ X_ S_
3.24.48	If the IUT cannot support the traffic parameters specified in the ATM traffic descriptor information element and cannot support the traffic parameter values in the Alternative ATM traffic descriptor information element or the Minimum acceptable ATM traffic descriptor information element, is the connection establishment rejected with cause #37 and a Crankback information element with a corresponding Crankback cause code?		M	6.5.2.3.4	Yes_ No_ X_ S_
3.24.49 ³	<u>If the preceding side receives a setup request from a previous interface that is not a PNNI interface, the ATM service category of the call is CBR, real-time VBR, or non-real-time VBR, and no Extended QoS parameters information element is contained in the received SETUP message, does the preceding side generate an Extended QoS parameters information element, using a local mapping from the service category and the forward and backward QoS class fields in the QoS parameter information element?</u> there is no Extended QoS Parameters information element in the received SETUP message, does the preceding side generate an Extended QoS Parameters information element?		M	6.5.2.3.5	Yes_ No_ X_ S_
3.24.50 ³	If there is no End-to-end transit delay information element in the received SETUP message, is <u>does</u> the preceding side capable of generate <u>generating</u> an End-to-end transit delay information element?		OM	6.5.2.3.5	Yes_ No_ X_ S_
3.24.51 ³	For each <u>cumulative</u> parameter contained in the Extended QoS parameters information element, does the preceding side increment the forward cumulative values of that parameter? (Note 1)		M	6.5.2.3.5	Yes_ No_ X_ S_
3.24.52	For each parameter contained in the Extended QoS parameters information element, does the preceding side determine if the highest/lowest acceptable values of that parameter can be supported?		M	6.5.2.3.5	Yes_ No_ X_ S_
3.24.53 ³	For each <u>cumulative</u> parameter contained in the End-to-end transit delay information element, does the preceding side increment the forward cumulative values of that parameter? (Note 1)		M	6.5.2.3.5	Yes_ No_ X_ S_
3.24.54	For each parameter contained in the End-to-end transit delay information element, does the preceding side determine if the highest/lowest acceptable values of that parameter can be supported?		M	6.5.2.3.5	Yes_ No_ X_ S_
3.24.55	Does the succeeding side not use the Quality of Service parameters information element and pass it on?		M	6.5.2.3.5	Yes_ No_ X_ S_
3.24.56 ³	For each <u>cumulative</u> parameter contained in the Extended QoS parameters information element, does the succeeding side increment the backward cumulative values of that parameter? (Note 2)		M	6.5.2.3.5	Yes_ No_ X_ S_

3.24.57	For each parameter contained in the Extended QoS parameters information element, does the succeeding side determine if the highest/lowest acceptable values of that parameter can be supported?		M	6.5.2.3.5	Yes_ No_ X_ S_
3.24.58 ³	Item deleted. For each parameter contained in the Endtoend transit delay information element, does the succeeding side increment the backward cumulative values of that parameter? (Note 2)		M	6.5.2.3.5	Yes_ No_ X_ S_
3.24.59	For each parameter contained in the End-to-end transit delay information element, does the succeeding side determine if the highest/lowest acceptable values of that parameter can be supported?		M	6.5.2.3.5	Yes_ No_ X_ S_
3.24.60	If the Extended QoS parameters information element contains a non supported set of individual QoS parameters, does it return a RELEASE COMPLETE message with cause #49?		M	6.5.2.3.5	Yes_ No_ X_ S_
3.24.61	If the End-to-end transit delay information element contains a nonsupported set of individual parameters, does it return a RELEASE COMPLETE message with cause #49?		M	6.5.2.3.5	Yes_ No_ X_ S_
3.24.62 ³	Does the succeeding side adjust the Cumulative ABR RM fixed round trip time parameter in the ABR-ATC ³ setup parameters information element?	<u>OPT 8</u>	M	6.5.2.3.7	Yes_ No_ X_ S_
3.24.63	Does the succeeding side send a CALL PROCEEDING message to the preceding side to acknowledge the SETUP message?		M	6.5.2.4, 5.5.4.1.10	Yes_ No_ X_ S_
3.24.64	Does the succeeding side enter the Call Proceeding Sent state after sending the CALL PROCEEDING message?		M	6.5.2.4	Yes_ No_ X_ S_
3.24.65	On receipt of a CALL PROCEEDING message is timer T303 stopped?		M	6.5.2.4	Yes_ No_ X_ S_
3.24.66	On receipt of a CALL PROCEEDING message is timer T310 started?		M	6.5.2.4	Yes_ No_ X_ S_
3.24.67	On receipt of a CALL PROCEEDING message is the Call Proceeding Received state entered?		M	6.5.2.4	Yes_ No_ X_ S_
3.24.68	If a CONNECT, ALERTING, or a RELEASE message is not received prior to the expiration of timer T310, are clearing procedures initiated towards the originating interface with cause #102?		M	6.5.2.4	Yes_ No_ X_ S_
3.24.69	If a CONNECT, ALERTING, or a RELEASE message is not received prior to the expiration of timer T310, are clearing procedures initiated in the called party's direction with cause #102?		M	6.5.2.4	Yes_ No_ X_ S_
3.24.70	When the succeeding side receives an indication that the called party is alerting, does it send an ALERTING message to the preceding side?		M	6.5.2.5	Yes_ No_ X_ S_
3.24.71	When the succeeding side receives an indication that the called party is alerting, does it enter the Alerting Delivered state?		M	6.5.2.5	Yes_ No_ X_ S_
3.24.72	When an ALERTING message is received is timer T310 stopped?		M	6.5.2.5	Yes_ No_ X_ S_
3.24.73	When an ALERTING message is received is timer T301 started?		M	6.5.2.5	Yes_ No_ X_ S_
3.24.74	When an ALERTING message is received is the Alerting Received state entered?		M	6.5.2.5	Yes_ No_ X_ S_

3.24.75	When an ALERTING message is received is an alerting indication sent towards the calling user?		M	6.5.2.5	Yes_ No_ X_ S_
3.24.76	Upon receiving an indication from Call Control that the call has been accepted, is a CONNECT message sent?		M	6.5.2.6	Yes_ No_ X_ S_
3.24.77	Upon receiving an indication from Call Control that the call has been accepted, is the Active state entered?		M	6.5.2.6	Yes_ No_ X_ S_
3.24.78	On receipt of a CONNECT message, does the preceding side stop timer T310, if it is running?		M	6.5.2.6	Yes_ No_ X_ S_
3.24.79	On receipt of a CONNECT message, does the preceding side stop timer T301, if it is running?		M	6.5.2.6	Yes_ No_ X_ S_
3.24.80	On receipt of a CONNECT message, does the preceding side enter the Active state?		M	6.5.2.6	Yes_ No_ X_ S_
3.24.81	If the succeeding side determines that the requested service is not available, is crankback initiated?		M	6.5.2.7	Yes_ No_ X_ S_
3.24.82	If the succeeding side determines that it is not able to progress the call, is crankback initiated?		M	6.5.2.7	Yes_ No_ X_ S_
3.24.83	Does the preceding (succeeding) side initiate call clearing by sending a RELEASE message?		M	6.5.3.3	Yes_ No_ X_ S_
3.24.84	Does the preceding (succeeding) side initiate call clearing by starting timer T308?		M	6.5.3.3	Yes_ No_ X_ S_
3.24.85	Does the preceding (succeeding) side initiate call clearing by releasing the virtual channel?		M	6.5.3.3	Yes_ No_ X_ S_
3.24.86	Does the preceding (succeeding) side initiate call clearing by entering the Release Request state?		M	6.5.3.3	Yes_ No_ X_ S_
3.24.87	While not in the Null or clearing states does the succeeding (preceding) side enter the Release Indication state upon receipt of a RELEASE message?		M	6.5.3.3	Yes_ No_ X_ S_
3.24.88	While in the Release Indication state, does the succeeding (preceding) side send a RELEASE COMPLETE message once the virtual channel used for the call has been released?		M	6.5.3.3	Yes_ No_ X_ S_
3.24.89	Once the RELEASE COMPLETE message has been sent, does the succeeding (preceding) side release both the call reference and the virtual channel?		M	6.5.3.3	Yes_ No_ X_ S_
3.24.90	Once the RELEASE COMPLETE message has been sent, does the succeeding (preceding) side enter the Null state?		M	6.5.3.3	Yes_ No_ X_ S_
3.24.91	On receipt of the RELEASE COMPLETE message does the preceding (succeeding) side stop timer T308, if it is running?		M	6.5.3.3	Yes_ No_ X_ S_
3.24.92	On receipt of the RELEASE COMPLETE message does the preceding (succeeding) side release the virtual channel and the call reference?		M	6.5.3.3	Yes_ No_ X_ S_
3.24.93	On receipt of the RELEASE COMPLETE message does the preceding (succeeding) side enter the Null state?		M	6.5.3.3	Yes_ No_ X_ S_
3.24.94	If timer T308 expires for the first time, does the preceding (succeeding) side retransmit a RELEASE message with the cause value in the original RELEASE message?		M	6.5.3.3	Yes_ No_ X_ S_
3.24.95	If timer T308 expires for the first time, does the preceding (succeeding) side restart timer T308?		M	6.5.3.3	Yes_ No_ X_ S_
3.24.96	If timer T308 expires for the first time, does the preceding (succeeding) side stay in the Release Request state?		M	6.5.3.3	Yes_ No_ X_ S_
3.24.97	If timer T308 expires for the first time, does the preceding (succeeding) side retransmit a RELEASE message with a second cause IE with cause #102?		O	6.5.3.3	Yes_ No_ X_ S_

3.24.98	If no RELEASE or RELEASE COMPLETE message is received before the second expiry of timer T308, is the call reference released?		M	6.5.3.3, 6.5.3.4	Yes_ No_ X_ S_
3.24.99	If no RELEASE or RELEASE COMPLETE message is received before the second expiry of timer T308, is the Null state entered?		M	6.5.3.3, 6.5.3.4	Yes_ No_ X_ S_
3.24.100	If no RELEASE or RELEASE COMPLETE message is received before the second expiry of timer T308, are additional recovery procedures performed?		O	6.5.3.3, 6.5.3.4	Yes_ No_ X_ S_
3.24.101	If a RELEASE message is received while in the Release Request state is timer T308 stopped?		M	6.5.3.4	Yes_ No_ X_ S_
3.24.102	If a RELEASE message is received while in the Release Request state are the call reference and virtual channel released?		M	6.5.3.4	Yes_ No_ X_ S_
3.24.103	If a RELEASE message is received while in the Release Request state is the Null state entered?		M	6.5.3.4	Yes_ No_ X_ S_
3.24.104	When call/connection collision occurs when the traffic parameters indicated exceed the remaining resources on the interface, is the call/connection cleared with cause #47?		O.2	6.5.4	Yes_ No_ X_ S_
3.24.105	When call/connection collision occurs when the traffic parameters indicated exceed the remaining resources on the interface, is the call/connection cleared with cause #49?		O.2	6.5.4	Yes_ No_ X_ S_
3.24.106	When call/connection collision occurs when the traffic parameters indicated exceed the remaining resources on the interface, is the call/connection cleared with cause #51?		O.2	6.5.4	Yes_ No_ X_ S_
3.24.107	Does the preceding side implement the restart procedures?		M	6.5.5	Yes_ No_ X_ S_
3.24.108	Does the succeeding side implement the restart procedures?		M	6.5.5	Yes_ No_ X_ S_
3.24.109	When a restart collision occurs are the restart requests handled independently?		M	6.5.5.3	Yes_ No_ X_ S_
3.24.110	When a message is received with a protocol discriminator coded other than "PNNI signalling message", is that message ignored?		M	6.5.6.1	Yes_ No_ X_ S_
3.24.111	If the message compatibility instruction indicator is set to "message instruction field not significant" and whenever an unexpected message except, RELEASE, RELEASE COMPLETE, or an unrecognized message is received in any state other than the Null state, then is a STATUS message returned with cause #97?		O.3	6.5.6.4	Yes_ No_ X_ S_
3.24.112	If the message compatibility instruction indicator is set to "message instruction field not significant" and whenever an unexpected message except, RELEASE, RELEASE COMPLETE, or an unrecognized message is received in any state other than the Null state, then is a STATUS message returned with cause #101?		O.3	6.5.6.4	Yes_ No_ X_ S_
3.24.113	Whenever an unexpected RELEASE message is received, is the virtual channel released? the connection cleared? a RELEASE COMPLETE message sent? the call reference released? all timers stopped? the Null state entered? the PNNI Call Control informed?		M M M M M M M	6.5.6.4	X_ S_ Yes_ No_ Yes_ No_ Yes_ No_ Yes_ No_ Yes_ No_ Yes_ No_ Yes_ No_

3.24.114	Whenever an unexpected RELEASE COMPLETE message is received, is the virtual channel released? the connection cleared? the call reference released? all timers stopped? the Null state entered? the PNNI Call Control informed?		M M M M M M	6.5.6.4	Yes_ No_ X_ S_ Yes_ No_ Yes_ No_ Yes_ No_ Yes_ No_ Yes_ No_ Yes_ No_
3.24.115	Whenever indication of a Signalling AAL reset is received from the SAAL by means of the AALESTABLISHINDICATION and calls are in the clearing phase, is no action taken?		M	6.5.6.9	Yes_ No_ X_ S_
3.24.116	Whenever indication of a Signalling AAL reset is received from the SAAL by means of the AALESTABLISHINDICATION and calls are in the establishment phase, are they maintained?		M	6.5.6.9	Yes_ No_ X_ S_
3.24.117	In addition to maintaining calls in the establishment phase, are status enquiry procedures implemented?		O	6.5.6.9	Yes_ No_ X_ S_
3.24.118	Whenever indication of a Signalling AAL reset is received from the SAAL by means of the AALESTABLISHINDICATION and calls are in the active state, are they maintained?		M	6.5.6.9	Yes_ No_ X_ S_
3.24.119	If timer T309 expires prior to SAAL reestablishment is the virtual channel released? the connection cleared? the call reference released? the Null state entered? the PNNI Call Control informed?		M M M M M	6.5.6.10	X_ S_ Yes_ No_ Yes_ No_ Yes_ No_ Yes_ No_ Yes_ No_
3.24.120	To check the correctness of a call state, can a STATUS ENQUIRY message be sent?		O	6.5.6.11	Yes_ No_ X_ S_
3.24.121 ³	If timer T322 expires and no STATUS message was received, is the STATUS ENQUIRY message retransmitted?	3.24.120	O	6.5.6.11	Yes_ No_ X_ S_
3.24.122 ³	If the maximum number of retransmissions of the STATUS ENQUIRY message is reached, is the call cleared?	3.24.120	M	6.5.6.11	Yes_ No_ X_ S_
3.24.123 ³	If the maximum number of retransmissions of the STATUS ENQUIRY message is reached, is the PNNI-Call Control network management system notified?	3.24.120	O M	6.5.6.11	Yes_ No_ X_ S_
3.24.124	If the Progress indicator IE is included in the PROGRESS message and progress description is No. 1 are all supervisory timers stopped except for T301 and T322?		M	6.5.11	Yes_ No_ X_ S_
3.24.125	If the Progress indicator IE is included in the PROGRESS message and progress description is No. 2 are all supervisory timers stopped except for T301 and T322?		M	6.5.11	Yes_ No_ X_ S_
3.24.126	If the Progress indicator IE is included in the PROGRESS message and progress description is No. 4 are all supervisory timers stopped except for T301 and T322?		O	6.5.11	Yes_ No_ X_ S_
3.24.127 ³	If the IUT receives a message that is too short to contain a complete Message length information element, does it ignore that message?		<u>M</u>	6.5.6.2	Yes_ No_ X_ S_
3.24.128 ³	In a received message, if the Call reference information element octet 1 bits 5 through 8 do not equal 0, does the IUT ignore the message?		<u>M</u>	6.5.6.3.1	Yes_ No_ X_ S_
3.24.129 ³	In a received message, if the Call reference information element octet 1 bits 4 through 1 indicate a length other than 3 octets, does the IUT ignore the message?		<u>M</u>	6.5.6.3.1	Yes_ No_ X_ S_

<u>3.24.130</u> ³	<u>When a received message specifies a call reference that is not recognized as relating to an active call or a call in progress, does the IUT follow the procedures of section 6.5.6.3.2</u>		<u>M</u>	<u>6.5.6.3.2</u>	<u>Yes No</u> <u>X S</u>
<u>3.24.131</u> ³	<u>When a SETUP message specifying a call reference that is recognized as relating to an active call or a call in progress is received, is it ignored by the IUT?</u>		<u>M</u>	<u>6.5.6.3.2</u>	<u>Yes No</u> <u>X S</u>
<u>3.24.132</u> ³	<u>When any message except RESTART, RESTART ACKNOWLEDGE or STATUS is received using the global call reference, does the IUT follow the procedures of section 6.5.6.3.2 item e) ?</u>		<u>M</u>	<u>6.5.6.3.2</u>	<u>Yes No</u> <u>X S</u>
<u>3.24.133</u> ³	<u>When a RESTART message specifying the global call reference with a call reference flag set to 1, does the IUT not take any action on the message and return a STATUS message indicating the current call state associated with the global call reference and cause No. 81 “invalid call reference”?</u>		<u>M</u>	<u>6.5.6.3.2</u>	<u>Yes No</u> <u>X S</u>
<u>3.24.134</u> ³	<u>When a RESTART ACKNOWLEDGE message specifying the global call reference with a call reference flag set to 0, does the IUT not take any action on the message and return a STATUS message indicating the current call state associated with the global call reference and cause No. 81 “invalid call reference”?</u>		<u>M</u>	<u>6.5.6.3.2</u>	<u>Yes No</u> <u>X S</u>
<u>3.24.135</u> ³	<u>If the IUT receives an unrecognized message with the “follow explicit instructions” flag set to 1 and the pass along request bit set to “no pass along request”, does it apply the procedures of section 6.5.7.1.2 ?</u>		<u>M</u>	<u>6.5.7.1.1</u>	<u>Yes No</u> <u>X S</u>
<u>3.24.136</u> ³	<u>If:</u> <ul style="list-style-type: none"> • <u>the IUT is not at an administrative boundary, and</u> • <u>an unrecognised message is received with the “follow explicit instructions” flag set to 1 and the pass along request (bit 4) set to “pass along request”, and</u> • <u>the next interface is pass along capable interface,</u> <u>Does the IUT forward the received message unchanged to the next interface (only updating the call reference and endpoint references if applicable)?</u>		<u>M</u>	<u>6.5.7.1.1</u>	<u>Yes No</u> <u>X S</u>
<u>3.24.137</u> ³	<u>If:</u> <ul style="list-style-type: none"> • <u>the IUT is not at an administrative boundary, and</u> • <u>an unrecognised message is received with the “follow explicit instructions” flag set to 1 and the pass along request (bit 4) set to “pass along request”, and</u> • <u>the next interface is not pass along capable,</u> <u>Does the IUT apply the error handling procedures defined in section 6.5.7.1.2 ?</u>		<u>M</u>	<u>6.5.7.1.1</u>	<u>Yes No</u> <u>X S</u>
<u>3.24.138</u> ³	<u>Does the IUT support the definition of policies regarding grant or denial of message pass along requests at administrative boundaries?</u>		<u>O</u>	<u>6.5.7.1.1</u>	<u>Yes No</u> <u>X S</u>
<u>3.24.139</u> ³	<u>If:</u> <ul style="list-style-type: none"> • <u>the IUT is at an administrative boundary, and</u> • <u>a policy decision results in denying a pass along request to a received unrecognised message,</u> <u>Does the IUT apply the error handling procedures defined in section 6.5.7.1.2 ?</u>	<u>3.24.138</u>	<u>M</u>	<u>6.5.7.1.1</u>	<u>Yes No</u> <u>X S</u>

3.24.140 ³	<p>If the IUT receives a mandatory information element:</p> <ul style="list-style-type: none"> with unrecognised contents, and the “follow explicit instructions” flag set to 1 and the pass along request (bit 4) set to “pass along request”, <p>Does the IUT ignore the setting of the “pass along request” flag and apply the procedures of section 6.5.7.2.2 ?</p>		<u>M</u>	<u>6.5.7.2.1</u>	<u>Yes No</u> <u>X S</u>
3.24.141 ³	<p>If the IUT receives:</p> <ul style="list-style-type: none"> an unexpected information element, or an unrecognised information element, or a recognised non mandatory information element with unrecognised contents, or a recognised non mandatory information element with length exceeding maximum length, <p>Then, if the next interface is not pass along capable, and:</p> <ul style="list-style-type: none"> the “follow explicit instructions” flag in the information element header is set to 1, and the pass along request bit set to “pass along request”, <p>Does the IUT ignore the setting of the “pass along request” flag and apply the error handling procedures of section 6.5.7.2.2 ?</p>		<u>M</u>	<u>6.5.7.2.1</u>	<u>Yes No</u> <u>X S</u>
3.24.142 ³	<p>If the IUT is not at an administrative boundary, and it receives:</p> <ul style="list-style-type: none"> an unexpected information element, or an unrecognised information element, or a recognised non mandatory information element with unrecognised contents, or a recognised non mandatory information element with length exceeding maximum length, <p>Then, if the next interface is pass along capable, and:</p> <ul style="list-style-type: none"> the “follow explicit instructions” flag in the information element header is set to 1, and the pass along request bit set to “pass along request”, <p>Does the IUT not process the contents of the information element?</p>		<u>M</u>	<u>6.5.7.2.1</u>	<u>Yes No</u> <u>X S</u>
3.24.143 ³	<p>If the IUT is not at an administrative boundary, and it receives:</p> <ul style="list-style-type: none"> an unexpected information element, or an unrecognised information element, or a recognised non mandatory information element with unrecognised contents, or a recognised non mandatory information element with length exceeding maximum length, <p>Then, if the next interface is pass along capable, and:</p> <ul style="list-style-type: none"> the “follow explicit instructions” flag in the information element header is set to 1, and the pass along request bit set to “pass along request”, <p>Does the IUT include the information element unaltered in the forwarded message?</p>		<u>M</u>	<u>6.5.7.2.1</u>	<u>Yes No</u> <u>X S</u>
3.24.144 ³	<p>Does the IUT support the information element Pass Along capability even when it has to convert the received message and forward it as another message (e.g. received ADD PARTY forwarded as a SETUP message) ?</p>		<u>M</u>	<u>6.5.7.2.1</u>	<u>Yes No</u> <u>X S</u>

<u>3.24.145</u> ³	<u>Does the IUT support the definition of policies regarding grant or denial of information element pass along requests at administrative boundaries?</u>		<u>O</u>	<u>6.5.7.2.1</u>	<u>Yes No</u> <u>X S</u>
<u>3.24.146</u> ³	<u>If:</u> <ul style="list-style-type: none"> • <u>the IUT is at an administrative boundary, and</u> • <u>a policy decision results in denying a pass along request to a received information element,</u> <u>Does the IUT apply the error handling procedures defined in section 6.5.7.2.2 ?</u>	<u>3.24.145</u>	<u>M</u>	<u>6.5.7.2.1</u>	<u>Yes No</u> <u>X S</u>
COMMENTS					
<p>O.1 The IUT must support at least one of these capabilities.</p> <p>O.2 The IUT must support at least one of these cause codes.</p> <p>O.3 The IUT must support at least one of these capabilities.</p> <p>Note 1 - When the previous interface is not a PNNI, the backward cumulative value may also be incremented, depending on the interface type.</p> <p>Note 2 - When the next interface is not a PNNI, the forward cumulative value may also be incremented, depending on the interface type.</p>					

15.1.3.25 Designated Transit Lists (Annex A)

Item	Protocol Feature	Conditions for status	Status Pred.	Spec. Ref.	Support
A.1	If a node removes DTLs from the stack, does it either not add DTLs to the stack or first remove the DTLs it added?		M	Annex A, 7	Yes_ No_ X_ S_
A.2	If the Transit network selection information element is present and the DTL originator does not find a path to the specified transit network, is the connection cleared with cause #2 "no route to specified transit network"?		M	Annex A, 7.2.1	Yes_ No_ X_ S_
A.3	If the DTL originator does not find a path to the called party and no Transit network selection information element is present, is the connection cleared with cause #3 "no route to destination"?		M	Annex A, 7.2.1	Yes_ No_ X_ S_
A.4	Are Designated transit list information elements pushed onto the stack in the reverse order in which they are to be traversed?		M	Annex A, 7.2.1	Yes_ No_ X_ S_
A.5	Does each Designated transit list information element contain, in the order which they are to be traversed, a list of transits at a single level of the hierarchy?		M	Annex A, 7.2.1	Yes_ No_ X_ S_
A.6	In the DTL stack appended to the SETUP or ADD PARTY message by the DTL originator, does the first Designated transit list information element to appear include the logical node that contains the DTL terminator?		M	Annex A, 7.2.1	Yes_ No_ X_ S_
A.7	In the DTL stack appended to the SETUP or ADD PARTY message by the DTL originator, does each Designated transit list information element contain as the first logical node to be traversed at that level, either the DTL originator?		M	Annex A, 7.2.1	Yes_ No_ X_ S_
A.8	In the DTL stack appended to the SETUP or ADD PARTY message by the DTL originator, is the current transit pointer set to zero in all Designated transit list information elements except for the top Designated transit list information element on the stack?		M	Annex A, 7.2.1, 7.3	Yes_ No_ X_ S_
A.9	In the top Designated transit list information element in the DTL stack received by the entry border node, if the logical node identifier indicated by the current transit pointer is not the same as the node ID of the border node's ancestor at the level of the common peer group for the receiving link is the call cleared with cause #41 "temporary failure"?	SS_B <u>AND</u> <u>NOT OPT 17</u> [NOT SS_B] <u>OR OPT 17</u>	M N/A	Annex A, 7.2.2 <u>Annex S</u>	Yes_ No_ X_ S_
A.10	Is the call cranked back with blocked transit type "call or party has been blocked at the succeeding end of this interface" and crankback cause #128 "next node unreachable"?	SS_B NOT SS_B	O N/A	Annex A, 7.2.2	Yes_ No_ X_ S_
A.11	Is the call cranked back with crankback cause #160 "DTL transit not my node ID" and the DTL transit listed as the blocked node?	SS_B NOT SS_B	O N/A	Annex A, 7.2.2	Yes_ No_ X_ S_
A.12	If one or more Designated transit list information elements is appended to the DTL stack by the entry border node, do these information elements specify a path to the target determined according to steps (a) and (b) of Section 7.2.2?	SS_B NOT SS_B	M N/A	Annex A, 7.2.2	Yes_ No_ X_ S_
A.13	Is this path consistent with all logical port identifiers indicated by the current transit pointers in Designated transit list information elements in the received DTL stack?	SS_B NOT SS_B	M N/A	Annex A, 7.2.2	Yes_ No_ X_ S_

A.14	If the entry border node cannot find a path to the target determined according to steps (a) and (b) of Section 7.2.2, is the call cleared or cranked back with the appropriate cause, as determined according to the procedures of Section 8.2.1?	SS_B NOT SS_B	M N/A	Annex A, 7.2.2	Yes_ No_ X_ S_
A.15	In the top Designated transit list information element in the DTL stack received by the node that is not the DTL originator or an entry border node, if the node identifier indicated by the current transit pointer is not the same as that node's own node identifier, is the call cleared with cause #41 "temporary failure"?	SS_B NOT SS_B	M N/A	Annex A, 7.2.3	Yes_ No_ X_ S_
A.16	Is the call cranked back with blocked transit type "call or party has been blocked at the succeeding end of this interface" and crankback cause #128 "next node unreachable"?		O	Annex A, 7.2.3	Yes_ No_ X_ S_
A.17	Is the call cranked back with crankback cause #160 "DTL transit not my node ID" and the DTL transit listed as the blocked node?		O	Annex A, 7.2.3	Yes_ No_ X_ S_
A.18	If the current transit pointer in the top Designated transit list information element on the received DTL stack does not point to the last transit in the DTL information element and the call is progressed with no additional DTL information elements appended to the DTL stack by this node, is the current transit pointer advanced to the next transit?		M	Annex A, 7.3	Yes_ No_ X_ S_
A.19	Is the call progressed using the logical port specified by the current transit pointer in the top Designated transit list information element on the received DTL stack?		M	Annex A, 7.3	Yes_ No_ X_ S_
A.20	If the current transit pointer in the top Designated transit list information element on the DTL stack received by a node that is not the DTL originator or an entry border node does not point to the last transit in the DTL information element, and either (i) the next transit is not a neighbor, or (ii) the specified logical port does not correspond to a logical link to the next transit, is the call cranked back with crankback cause #128 and cause #2 or cause #3?		M	Annex A, 7.3	Yes_ No_ X_ S_
A.21	If the current transit pointer in the top Designated transit list information element on the received DTL stack indicates the last transit in the DTL information element and the call is progressed with no additional DTL information elements appended to the DTL stack by this node, are one or more Designated transit list information elements popped from the stack according to the procedures of Section 7.3?		M	Annex A, 7.3	Yes_ No_ X_ S_
A.22	If there are any DTLs remaining on the DTL stack, is the current transit pointer in the top Designated transit list information element advanced to the next transit?	SS_B NOT SS_B	M N/A	Annex A, 7.3	Yes_ No_ X_ S_
A.23	Is the call progressed to the next transit using a port that is consistent with all logical port identifiers indicated by the current transit pointers in Designated transit list information elements in the received DTL stack?	SS_B NOT SS_B	M N/A	Annex A, 7.3	Yes_ No_ X_ S_

A.24	If the current transit pointers in all Designated transit list information elements on the DTL stack received by a node that is not the DTL originator or an entry border node indicate the last transit in the DTL information element, but there is no connectivity with sufficient membership scope to the called party or transit network, is the call cleared or cranked back according to the procedures of Section 8.2.1?		M	Annex A, 7.3	Yes_ No_ X_ S_
A.25	If the current transit pointers in all Designated transit list information elements on the DTL stack received by a node that is not the DTL originator or an entry border node indicate the last transit in the DTL information element, and the call is progressed, is a port used that is consistent with the port ID specified by the current transit pointer in the top DTL of the received DTL stack?		M	Annex A, 7.3	Yes_ No_ X_ S_
A.26	When DTLs are pushed onto the DTL stack, are port IDs left unspecified whenever the next node in the DTL stack is represented in the topology database using the simple node representation or the default node representation?		O	Annex A, 7.4	Yes_ No_ X_ S_
A.27	When DTLs are pushed onto the DTL stack, are port IDs specified whenever the next node in the DTL stack is represented using the complex node representation with one or more exceptions?		O	Annex A, 7.4	Yes_ No_ X_ S_
<u>A.28</u> ³	<u>In the top Designated transit list information element in the DTL stack received by the entry border node, if the logical node identifier indicated by the current transit pointer is not the same as the node ID of the border node's ancestor at the level of the common peer group for the receiving link and is not the lowest node ID of the border node, is the call cleared with cause #2 "no route to specified transit network" or cause #3 "no route to destination"?</u>	<u>SS B AND OPT 17</u> <u>[NOT SS B] OR NOT OPT 17</u>	<u>M</u> <u>N/A</u>	<u>Annex A, 7.2.2</u> <u>Annex S</u>	<u>Yes_ No_</u> <u>X_ S_</u>
<u>A.29</u> ³	<u>In the top Designated transit list information element in the DTL stack received by the entry border node, if the entry border node is a restricted transit node and the current transit pointer does not indicate the end of the DTL, is the call cleared with cause #2 "no route to specified transit network" or cause #3 "no route to destination", and cranked back with blocked transit type "blocked node" specifying the saved logical node identifier as the blocked node, the blocked node's level as the crankback level subfield, and crankback cause #129 "node is a restricted transit node" ?</u>	<u>SS B</u> <u>NOT SS B</u>	<u>M</u> <u>N/A</u>	<u>Annex A, 7.2.2</u>	<u>Yes_ No_</u> <u>X_ S_</u>
<u>A.30</u> ³	<u>When the entry border node is inspecting the next lower DTLs on the stack to determine the routing target and the current transit pointer in one of these DTLs is a restricted transit node, and a lower DTL on the stack exists that has a current transit pointer that does not indicate the end of the DTL, is the call cleared with cause #2 "no route to specified transit network" or cause #3 "no route to destination" and cranked back with a blocked transit type of "blocked node" specifying the saved logical node identifier as the blocked node, the blocked node's level as the crankback level subfield, and crankback cause #129 "node is a restricted transit node" ?</u>	<u>SS B</u> <u>NOT SS B</u>	<u>M</u> <u>N/A</u>	<u>Annex A, 7.2.2</u>	<u>Yes_ No_</u> <u>X_ S_</u>

<u>A.31</u> ³	If the entry border node is a restricted transit node and the path found in step (c) of Section 7.2.2 indicates the entry border node is not the terminating node, is the call released with cause #2 “no route to specified transit network” or cause #3 “no route to destination” and cranked back with a blocked transit type of “call or party has been blocked at the succeeding end of this interface”, with a crankback level subfield set as specified in Section 8.3.1.3, and crankback cause #129 “node is a restricted transit node” ?	<u>SS_B</u> <u>NOT SS_B</u>	<u>M</u> <u>N/A</u>	<u>Annex A,</u> <u>7.2.2</u>	<u>Yes No</u> <u>X S</u>
<u>A.32</u> ³	If the target is a node in step (c) of Section 7.2.2, and any of the border node’s ancestors up to the level of the target is a restricted transit node, is the call released with cause #2 “no route to specified transit network” or cause #3 “no route to destination”, and cranked back with a blocked transit type of “call or party has been blocked at the succeeding end of this interface”, with a crankback level subfield set as specified in Section 8.3.1.3, and crankback cause #129 “node is a restricted transit node” ?	<u>SS_B</u> <u>NOT SS_B</u>	<u>M</u> <u>N/A</u>	<u>Annex A,</u> <u>7.2.2</u>	<u>Yes No</u> <u>X S</u>
<u>A.33</u> ³	If the target is not a node in step (c) of Section 7.2.2, and any of the border node’s ancestors is a restricted transit node, does the entry border node select a path that leads to a node with connectivity to the target which is at a level that is lower than the lowest level restricted transit ancestor ?	<u>SS_B</u> <u>NOT SS_B</u>	<u>M</u> <u>N/A</u>	<u>Annex A,</u> <u>7.2.2</u>	<u>Yes No</u> <u>X S</u>
<u>A.34</u> ³	If the target is not a node in step (c) of Section 7.2.2, and any of the border node’s ancestors is a restricted transit node, and no node with connectivity to the target can be found that is lower than the lowest level restricted transit ancestor, is the call released with cause #2 “no route to specified transit network” or cause #3 “no route to destination”, and cranked back with a blocked transit type of “call or party has been blocked at the succeeding end of this interface”, with a crankback level subfield set as specified in Section 8.3.1.3, and crankback cause #129 “node is a restricted transit node” ?	<u>SS_B</u> <u>NOT SS_B</u>	<u>M</u> <u>N/A</u>	<u>Annex A,</u> <u>7.2.2</u>	<u>Yes No</u> <u>X S</u>
<u>A.35</u> ³	If the top DTL information element on the DTL stack is at the lowest possible level of the routing hierarchy, and the current transit pointer in the top DTL does not point to the last transit in the DTL, and this node (at the lowest level) is a restricted transit node, is the call cleared with cause #2 “no route to specified transit network” or cause #3 “no route to destination” and cranked back with a blocked transit type of “blocked node” specifying the current transit as the blocked node, and crankback cause #129 “node is a restricted transit node” ?	<u>SS_B</u> <u>NOT SS_B</u>	<u>M</u> <u>N/A</u>	<u>Annex A,</u> <u>7.2.3</u>	<u>Yes No</u> <u>X S</u>

<u>A.36</u> ³	<u>When the current transit pointer in the top designated transit list information element on the DTL stack (after the procedures of Section 7.2 have been completed) does not point to the last transit in the DTL information element and the LowestLevelExitBorderIsRestrictedTransit flag is set to TRUE (as specified in Section 7.2.3), is the call cleared with cause #2 “no route to specified transit network” or cause #3 “no route to destination” and cranked back with a blocked transit type of “blocked node” specifying the logical node identifier saved when the flag was set to TRUE as the blocked node, the blocked node’s level as the crankback level subfield, and crankback cause #129 “node is a restricted transit node” ?</u>	<u>SS B</u> <u>NOT SS B</u>	<u>M</u> <u>N/A</u>	<u>Annex A,</u> <u>7.3</u>	<u>Yes No</u> <u>X S</u>
--------------------------	---	------------------------------------	----------------------------	-------------------------------	-----------------------------

15.1.3.26 Crankback Procedures (Annex B)

Item	Protocol Feature	Conditions for status	Status Pred.	Spec. Ref.	Support
B.1	Is crankback performed only where stated explicitly in the PNNI v1.0 specification?		M	Annex B, 8.1	Yes_ No_ X_ S_
B.2	When a call progresses all the way to the called user and gets rejected by the called user, is the call cleared all the way back to the calling user and not cranked back?		M	Annex B, 8.1	Yes_ No_ X_ S_
B.3	Are calls that get rejected when the DTL terminator determines that the UNI to the called user cannot carry the call cranked back?		O	Annex B, 8.2	Yes_ No_ X_ S_
B.4	Whenever crankback occurs due to reachability errors, is the blocked transit specified in the Crankback information element a blocked link?		M	Annex B, 8.2.1	Yes_ No_ X_ S_
B.5	For unreachable transit networks and called party addresses, is the Blocked link's succeeding node ID set to all zeros?		M	Annex B, 8.2.1	Yes_ No_ X_ S_
B.6	When the node receives a SETUP or ADD PARTY message with a DTL stack indicating that it is the last node in the path, but no reachability information exists in the node's topology database to the called party or transit network, is the call cleared with cause #2 "no route to specified transit network" or cause #3 "no route to destination"?		M	Annex B, 8.2.1.1	Yes_ No_ X_ S_
B.7	When the node receives a SETUP or ADD PARTY message with a DTL stack indicating that it is the last node in the path, and the node's topology database includes reachability information for the called party or transit network, but only at one or more different nodes (that are not ancestors of this node), is the call cranked back with cause and crankback cause #2 or #3?		M	Annex B, 8.2.1.1	Yes_ No_ X_ S_
B.8	When the next transit in the DTL stack is not directly reachable from this node and a Transit network selection information element is present, is the call cranked back with crankback cause #128 "next node unreachable" and cause #2 "no route to specified transit network"?		M	Annex B, 8.2.1.2	Yes_ No_ X_ S_
B.9	When the next transit in the DTL stack is not directly reachable from this node and no Transit network selection information element is present, is the call cranked back with crankback cause #128 "next node unreachable" and cause #3 "no route to destination"?		M	Annex B, 8.2.1.2	Yes_ No_ X_ S_
B.10	Are calls that are rejected in PNNI domains due to insufficient resources always cranked back?		M	Annex B, 8.2.2.2	Yes_ No_ X_ S_
B.11	If the requested user cell rate(s) from the ATM traffic descriptor information element cannot be satisfied, is the call cranked back with crankback cause #37 "user cell rate not available"?		M	Annex B, 8.2.2.2	Yes_ No_ X_ S_
B.12	If no path can be found to satisfy the requested maximum CTD, peaktopeak CDV, and/or CLR (in one and/or the other direction for the call), is the call cranked back with cause and crankback cause #49 "QoS unavailable"?		M	Annex B, 8.2.2.2	Yes_ No_ X_ S_

B.13	Are the specific QoS parameter(s) that caused the call rejection indicated in the diagnostics by setting the appropriate bits to "CTD unavailable", "CDV unavailable", and/or "CLR unavail able"?		M	Annex B, 8.2.2.2	Yes_ No_ X_ S_
B.14	When blocking due to insufficient resources occurs, are the procedures of Section 8.3.1.1, 8.3.1.2, or 8.3.1.3 applied?		M	Annex B, 8.2.2.2	Yes_ No_ X_ S_
B.15	When the preceding side is unable to allocate a VPCI (for SVPCs) or a VPCI/VCI pair (for SVCCs), are the procedures of Section 8.3.1.2 followed?		M	Annex B, 8.2.2.3	Yes_ No_ X_ S_
B.16	When the preceding side is unable to allocate a VPCI (for SVPCs) or a VPCI/VCI pair (for SVCCs) and no alternate routing is attempted or alternate routing fails, is the call cranked back with crankback cause #45 "No VPCI/VCI available"?		M	Annex B, 8.2.2.3	Yes_ No_ X_ S_
B.17	Whenever VPCI/VCI resource errors occur at the succeeding side of a PNNI interface, is the blocked transit type in the Crankback information element set to "call or party has been blocked at the succeeding end of this interface"?		M	Annex B, 8.2.2.3	Yes_ No_ X_ S_
B.18	When cranking back due to blocking at the node, does the Crankback information element include a crankback level sub field whose value is set to the level of the first node ID indicated in the top DTL of the stack?		M	Annex B, 8.3.1.1, 8.3.2.2.2	Yes_ No_ X_ S_
B.19	Is the blocked transit type set to "blocked node" and does the blocked transit identifier indicate the node's own node ID at the corresponding level of hierarchy, as indicated by the current transit pointer in the top DTL on the stack in the received SETUP or ADD PARTY message?		M	Annex B, 8.3.1.1, 8.3.2.2.2	Yes_ No_ X_ S_
B.20	When cranking back due to blocking at the preceding end of a link, does the Crankback information element include a crank back level subfield whose value is set to the level of the first node ID indicated in the top DTL of the stack?		M	Annex B, 8.3.1.2, 8.3.2.2.2	Yes_ No_ X_ S_
B.21	Is the blocked transit type set to "blocked link" and the blocked link's preceding node identifier and port identifier set to the node and port IDs indicated by the current transit pointer in the top DTL of the stack in the received SETUP or ADD PARTY message?		M	Annex B, 8.3.1.2, 8.3.2.2.2	Yes_ No_ X_ S_
B.22	If the node is not the last node in the top DTL on the stack, is the blocked link's succeeding node identifier set to the next node ID in the top DTL on the stack?		M	Annex B, 8.3.1.2, 8.3.2.2.2	Yes_ No_ X_ S_
B.23	If the node is an exit border node for the call, is the blocked link's succeeding node identifier set to the next node determined from the received DTL stack according to the procedures of Section 7.3?	SS_B NOT SS_B	M N/A	Annex B, 8.3.1.2, 8.3.2.2.2	Yes_ No_ X_ S_
B.24	If the node is the DTL terminator for the call, is the blocked link's succeeding node identifier set to all zeros?		M	Annex B, 8.3.1.2, 8.3.2.2.2	Yes_ No_ X_ S_
B.25	When cranking back due to blocking at the succeeding end of a link, does the Crankback information element include a crankback level subfield whose value is set to the level of the first node ID indicated in the top DTL of the stack?		M	Annex B, 8.3.1.3	Yes_ No_ X_ S_

B.26	When a clearing message including a Crankback information element with blocked transit type other than "call or party has been blocked at the succeeding end of this interface" is received and the node did not generate any DTLs for this call of equal or higher level than the crankback level, does the node crankback the call or party by sending a RELEASE or ADD PARTY REJECT message including an unchanged Crankback information element over its previous interface (towards the calling party)?		M	Annex B, 8.3.2	Yes_ No_ X_ S_
B.27	When a clearing message including a Crankback information element with blocked transit type "call or party has been blocked at the succeeding end of this interface" is received by the node that is not an entry border node for the call, and other links exist that still satisfy the DTLs in the SETUP or ADD PARTY message received by this node, is alternate routing attempted?	OPT_2 NOT OPT_2	O N/A	Annex B, 8.3.2.1	Yes_ No_ X_ S_
B.28	If the crankback cause was #35 "Requested VPCI/VCI not available", is the SETUP message resent on the blocked link with a different VPCI (for SVPCs) or VPCI/VCI pair (for SVCCs)?		O	Annex B, 8.3.2.1	Yes_ No_ X_ S_
B.29	If no alternate routing is attempted or if alternate routing fails, does the node continue to crankback the call or party with a crankback level subfield whose value is set to the level of the first node ID indicated in the top DTL of the received DTL stack?		M	Annex B, 8.3.2.1	Yes_ No_ X_ S_
B.30	Is the blocked transit type set to "blocked link" and the blocked link's preceding node identifier and port identifier set to the node and port IDs indicated by the current transit pointer in the top DTL of the stack in the received SETUP or ADD PARTY message?		M	Annex B, 8.3.2.1	Yes_ No_ X_ S_
B.31	If the node is not the last node in the top DTL on the stack, is the blocked link's succeeding node identifier set to the next node ID in the top DTL on the stack?		M	Annex B, 8.3.2.1	Yes_ No_ X_ S_
B.32	If the node is an exit border node for the call, is the blocked link's succeeding node identifier set to the next node determined from the received DTL stack according to the procedures of Section 7.3?	SS_B NOT SS_B	M N/A	Annex B, 8.3.2.1	Yes_ No_ X_ S_
B.33	If the node is the DTL terminator for the call, is the blocked link's succeeding node identifier set to all zeros?		M	Annex B, 8.3.2.1	Yes_ No_ X_ S_
B.34	When a clearing message including a Crankback information element with either blocked transit type "call or party has been blocked at the succeeding end of this interface" or crankback level lower than or equal to the highest level DTL generated by this node for this call is received by the entry border node or DTL originator, is alternate routing attempted?	OPT_2 NOT OPT_2	O N/A	Annex B, 8.3.2, 8.3.2.1, 8.3.2.2	Yes_ No_ X_ S_
B.35	If alternate routing is attempted, is the path consistent with the DTLs in the originally received SETUP or ADD PARTY message?	SS_B and OPT_2 NOT (SS_B and OPT_2)	M N/A	Annex B, 8.3.2.2.1	Yes_ No_ X_ S_
B.36	If alternate routing is attempted, does the path avoid all blocked nodes and/or links received in the Crankback information element of any clearing messages?	OPT_2 NOT OPT_2	M N/A	Annex B, 8.3.2.2.1	Yes_ No_ X_ S_

B.37	If alternate routing is not attempted or if alternate routing fails, does crankback proceed with the crankback level set to the level of the first node in the top DTL on the stack and the identity of the blocked node or link changed to reflect a node or link known to the parent peer group?	SS_B NOT SS_B	M N/A	Annex B, 8.3.2.2.2	Yes_ No_ X_ S_
B.38	If only nodes and/or links internal to the peer group were returned as blocked nodes or links in the Crankback information element, is the logical group node corresponding to the peer group listed as blocked?	SS_B NOT SS_B	O N/A	Annex B, 8.3.2.2.2	Yes_ No_ X_ S_
B.39	If at least one of the routing attempts was blocked at a link exiting the peer group, is the logical link exiting the logical group node representing the peer group listed as blocked?	SS_B NOT SS_B	O N/A	Annex B, 8.3.2.2.2	Yes_ No_ X_ S_
B.40	If the network node receives a RELEASE or RELEASE COMPLETE message with a Crankback information element indicating blocked transit type "call or party has been blocked at the succeeding end of this interface" and there are pending add party requests on the add party queue, for each queued add party request does the node either (i) send an ADD PARTY REJECT message towards the preceding network node, or (ii) reroute the add party request so as to avoid this interface?		M	Annex B, 8.3.2.3	Yes_ No_ X_ S_
B.41	If the network node receives a RELEASE or RELEASE COMPLETE message with a Crankback information element indicating blocked transit type other than "call or party has been blocked at the succeeding end of this interface" and there are pending add party requests on the add party queue, does the network node progress one of the add party requests on the add party queue by sending a SETUP message, leaving the remaining add party requests pending?		O.1	Annex B, 8.3.2.3	Yes_ No_ X_ S_
B.42	If the network node receives a RELEASE or RELEASE COMPLETE message with a Crankback information element indicating blocked transit type other than "call or party has been blocked at the succeeding end of this interface" and there are pending add party requests on the add party queue, does the network node crankback or reroute each add party request on the add party queue whose DTL stack contains the blocked transit, and progress one of the add party requests remaining on the add party queue (if any) by sending a SETUP message, leaving the remaining add party requests pending?		O.1	Annex B, 8.3.2.3	Yes_ No_ X_ S_
B.43	If an add party request is rerouted to a branch in the Active state, is an ADD PARTY message sent to the corresponding succeeding node?		M	Annex B, 8.3.2.3	Yes_ No_ X_ S_
B.44	If an add party request is rerouted to a branch that is in the Null state, is a SETUP message sent to the corresponding succeeding node?		M	Annex B, 8.3.2.3	Yes_ No_ X_ S_
B.45	If an add party request is rerouted to a branch in the Call Initiated, Outgoing Call Proceeding, or Call Delivered State, is the add party request queued?		M	Annex B, 8.3.2.3	Yes_ No_ X_ S_
B.46	Are updated GCAC parameter values included as diagnostics for crankback cause #37 "user cell rate not available"?		O	Annex B, 8.4	Yes_ No_ X_ S_

B.47	When the preceding node receives a call clearing message including a Crankback information element with blocked transit type "call or party has been blocked at the succeeding end of this interface" and containing updated GCAC parameter values with the direction set to "backward", and the port is not aggregated into another logical port by this node, is a port ID inserted that identifies its port for the PNNI interface?		M	Annex B, 8.4	Yes_ No_ X_ S_
B.48	When the exit border node receives a call clearing message including a Crankback information element with blocked transit type "call or party has been blocked at the succeeding end of this interface" and containing updated GCAC parameter values and the specified port is aggregated into another logical port by this node, are the updated parameter values and port ID either replaced with values for the aggregate link or discarded?	SS_B NOT SS_B	M N/A	Annex B, 8.4	Yes_ No_ X_ S_
B.49	When the entry border node receives a call clearing message including a Crankback information element containing updated GCAC parameter values, the call is cranked back to a new level of hierarchy, and the specified port is not aggregated into another logical port at the new level of hierarchy, is the port ID included with the updated topology state parameter values updated?	SS_B NOT SS_B	M N/A	Annex B, 8.4	Yes_ No_ X_ S_
B.50	When the entry border node receives a call clearing message including a Crankback information element containing updated GCAC parameter values, the call is cranked back to a new level of hierarchy, and the specified port is aggregated into another logical port at the new level of hierarchy, are the updated parameter values and port ID either replaced with values for the aggregate link or discarded?	SS_B NOT SS_B	M N/A	Annex B, 8.4	Yes_ No_ X_ S_
<u>B.51³</u>	<u>Does the IUT generate a significant change event for PTSE describing a topological entity, and invoke the procedures of section 5.8.5.2 when:</u> <u>1. The current AvCR on the topological entity that failed CAC is within the insignificant change range (as defined in Section 5.8.5.2.5.4), and</u> <u>2. The call does not pass GCAC using the current AvCR on the topological entity for the call's service category (and therefore the call failed CAC and blocked), and</u> <u>3. The call passes GCAC using the last advertised AvCR value for the call's service category for the topological entity that failed CAC ?</u>		<u>O</u>	<u>Annex B, 8.5</u>	<u>Yes_ No_ X_ S_</u>
COMMENTS					
O.1 At least one of these must be supported					

15.1.3.27 Soft PVC Procedures (Annex C)

Item	Protocol Feature	Conditions for status	Status Pred.	Spec. Ref.	Support
	When supporting Soft PVC (OPT_7) and this call is a SPVC call ...				
C.1 ³	Item deleted. are the following information elements: -AAL parameters, -Broadband high layer information, -Broadband low layer information, -Called party subaddress, and -Calling party subaddress, not included in the following messages: -SETUP, -CONNECT, -ADD PARTY, and -ADD PARTY ACK?	OPT_7 NOT OPT_7	M N/A	Annex C, 9.1	Yes_ No_ X_ S_
C.2	are the following specific parameters not negotiable: - traffic parameters and - QoS parameters?	OPT_7 NOT OPT_7	M N/A	Annex C, 9.2	Yes_ No_ X_ S_
C.3	if the traffic parameters or QoS parameters as specified in the SETUP message cannot be supported by the switching system, is the call cranked back with cause and crankback cause #47, "Resources not available, unspecified"?	OPT_7 NOT OPT_7	M N/A	Annex C, 9.2	Yes_ No_ X_ S_
C.4	does the owner of the PVPC/PVCC connecting point initiate PVPC/PVCC establishment?	OPT_7 NOT OPT_7	M N/A	Annex C, 9.2.1	Yes_ No_ X_ S_
C.5	is a SETUP message sent when the PVPC/PVCC is initially configured?	OPT_7 NOT OPT_7	M N/A	Annex C, 9.2.1	Yes_ No_ X_ S_
C.6	is a SETUP message sent when the switching node which is owner of the PVPC/PVCC becomes operational (e.g., power up)?	OPT_7 NOT OPT_7	M N/A	Annex C, 9.2.1	Yes_ No_ X_ S_
C.7	is a SETUP message sent when recovering from an outage?	OPT_7 NOT OPT_7	M N/A	Annex C, 9.2.1	Yes_ No_ X_ S_
C.8	is a Bearer class of VP included in the Broadband bearer capability IE for a VPC?	OPT_7 NOT OPT_7	M N/A	Annex C, 9.2.1	Yes_ No_ X_ S_
C.9	is a Bearer class of X included in the Broadband bearer capability IE for a VCC?	OPT_7 NOT OPT_7	M N/A	Annex C, 9.2.1, 9.3.2	Yes_ No_ X_ S_
C.10	is the Called party Soft PVPC/VPCC information element included in the SETUP message?	OPT_7 NOT OPT_7	M N/A	Annex C, 9.2.1, 9.3.2	Yes_ No_ X_ S_
C.11	does the Called party number information element contain the configured peer PVPC/PVCC connecting point identifier?	OPT_7 NOT OPT_7	M N/A	Annex C, 9.2.1, 9.3.2	Yes_ No_ X_ S_
C.12	does the Calling party number information element contain the PVPC/PVCC connecting point's own identifier?	OPT_7 NOT OPT_7	M N/A	Annex C, 9.2.1, 9.3.2	Yes_ No_ X_ S_

C.13	when the originating node receives a CONNECT message, does it put the PVPC/PVCC in an operational state?	OPT_7	M	Annex C, 9.2.2	Yes_ No_ X_ S_
		NOT OPT_7	N/A		
C.14	if the CONNECT message contains the Called party Soft PVPC/PVCC information element, is the VPCI or VPCI/VCI values of the PVPC/PVCC segment between the called connecting point and the user passed to the management entity?	OPT_7	M	Annex C, 9.2.2	Yes_ No_ X_ S_
		NOT OPT_7	N/A		
C.15	when a SETUP message is received at the called NI are the procedures of sections 6.5.2.4 and 6.5.2.6 followed?	OPT_7	M	Annex C, 9.2.3	Yes_ No_ X_ S_
		NOT OPT_7	N/A		
C.16	for the last PVPC segment does the calling connecting point indicate for the called endpoint of Soft PVPC either any VPCI or required VPCI?	OPT_7	M	Annex C, 9.2.3.1	Yes_ No_ X_ S_
		NOT OPT_7	N/A		
C.17	if the received VPCI is set to required and is not available, is a RELEASE COMPLETE message with cause #34, "requested called party Soft PVPC/PVCC not available sent?	OPT_7	M	Annex C, 9.2.3.1	Yes_ No_ X_ S_
		NOT OPT_7	N/A		
C.18	for the last PVCC segment does the calling connecting point indicate for the called endpoint of Soft PVPC either - any VPCI; any VCI or - Required VPCI; required VCI?	OPT_7	M	Annex C, 9.2.3.2	Yes_ No_ X_ S_
		NOT OPT_7	N/A		
C.19	if the received VPCI/VCI is set to required and is not available, is a RELEASE COMPLETE message with cause #34, "requested called party Soft PVPC/PVCC not available sent?	OPT_7	M	Annex C, 9.2.3.2	Yes_ No_ X_ S_
		NOT OPT_7	N/A		

15.1.3.28 Soft PVC Point-to-Multipoint Procedures

Item	Protocol Feature	Conditions for status	Status Pred.	Spec. Ref.	Support
	When supporting Soft PVC (OPT_7) and this call is a Soft PVC call for point-to-multipoint PVCs ...				
C.20	is the connection established for a point-to-multipoint PVPC /PVCC initiated by the root connecting point?	OPT_7 NOT OPT_7	M N/A	Annex C, 9.3.1	Yes_ No_ X_ S_
C.21	is a SETUP/ADD PARTY message sent to one of the leaf connecting points when any of the following occurs: - PVPC /PVCC initially configured, - a new party added by network management, - when the switching node which is the root connecting point becomes operational (e.g., power up), or - during recovery from an outage?	OPT_7 NOT OPT_7	M N/A	Annex C, 9.3.1	Yes_ No_ X_ S_
C.22	is the set up of the first party of the point-to-multi point PVPC /PVCC always initiated by sending a SETUP message?	OPT_7 NOT OPT_7	M N/A	Annex C, 9.3.2	Yes_ No_ X_ S_
C.23	when the originating node receives a CONNECT message, does it put the PVPC/PVCC in an operational state?	OPT_7 NOT OPT_7	M N/A	Annex C, 9.3.2.1, 9.2.2	Yes_ No_ X_ S_
C.24	if the CONNECT message contains the Called party Soft PVPC/PVCC information element, are the VPCI or VPCI /VCI values of the PVPC or PVCC segment, <u>respectively</u> , between the called connecting point and the user passed to the management entity?	OPT_7 NOT OPT_7	M N/A	Annex C, 9.3.2.1, 9.2.2	Yes_ No_ X_ S_
C.25	when a SETUP message received at the called NI are the procedures of sections 6.5.2.4 and 6.5.2.6 followed?	OPT_7 NOT OPT_7	M N/A	Annex C, 9.3.2.2, 9.2.3	Yes_ No_ X_ S_
C.26	after the connection is established to the first leaf, are connections established to additional leaves by sending an ADD PARTY message for each leaf?	OPT_7 NOT OPT_7	M N/A	Annex C, 9.3.3	Yes_ No_ X_ S_
C.27	is the Called party Soft PVPC/PVCC information element included in the ADD PARTY message?	OPT_7 NOT OPT_7	M N/A	Annex C, 9.3.3	Yes_ No_ X_ S_
C.28	does the Called party number information element in the ADD PARTY message contain the configured leaf PVPC /PVCC connecting point identifier?	OPT_7 NOT OPT_7	M N/A	Annex C, 9.3.3	Yes_ No_ X_ S_
C.29	does the Calling party number information element in the ADD PARTY message contain the root PVPC /PVCC connecting point's own identifier?	OPT_7 NOT OPT_7	M N/A	Annex C, 9.3.3	Yes_ No_ X_ S_
C.30	if the ADD PARTY ACKNOWLEDGE message contains the Called party Soft PVPC/PVCC information element, are the VPCI or VPCI /VCI values of the PVPC or PVCC segment, <u>respectively</u> , between the called connecting point and the user passed to the management entity?	OPT_7 NOT OPT_7	M N/A	Annex C, 9.3.3.1	Yes_ No_ X_ S_
C.31	when an ADD PARTY message is received at the called NI, are procedures of 6.6.2 followed?	OPT_7 NOT OPT_7	M N/A	Annex C, 9.3.3.2	Yes_ No_ X_ S_

C.32	for the last PVCC segment does the calling connecting point indicate for the called endpoint of Soft PVCC either - any VPCI; any VCI or - required VPCI; required VCI?	OPT_7 NOT OPT_7	M N/A	Annex C, 9.3.3.2.1	Yes_ No_ X_ S_
C.33	if the received VPCI/VCI is set to required and is not available, is an ADD PARTY REJECT message with cause #34, "requested called party Soft PVPC/PVCC not available", sent?	OPT_7 NOT OPT_7	M N/A	Annex C, 9.3.3.2.1	Yes_ No_ X_ S_

15.1.3.29 Interoperability Questions

Item	Protocol Feature	Conditions for status	Status Pred.	Spec. Ref.	Support
NC1	Does the address assignment of the IUT correspond to the topographical hierarchy?		M	5.2.15.2.2 ³	Yes_ No_ X_ S_
NC2	Does each node have a unique ATM address?		M	5.2.25.2.4 ³	Yes_ No_ X_ S_
NC3	Are the Peer Group identifiers prefixes of ATM End System addresses, which the organization that administers the peer group has assignment authority over that prefix?		M	5.3.2	Yes_ No_ X_ S_
NC4	Is the opaque value unique within the entire routing domain?		M	5.3.3	Yes_ No_ X_ S_
NC5	Can the ATM duplex links have different characteristics in each direction?		M	5.3.4	Yes_ No_ X_ S_
NC6	If two lowest level nodes are connected by a VPC which is to be used for PNNI, does each node know by configuration or management that the VPC exists and is used for PNNI?		M	5.4	Yes_ No_ X_ S_
NC7	If the level indicator is set to zero, is the address advertised throughout the PNNI routing domain?		M	5.9.1	Yes_ No_ X_ S_
NC8	Are peer group IDs specified at configuration time?		M	3.2.1	Yes_ No_ X_ S_
NC9	Is the peer group ID at most 13 octets?		M	3.2.1	Yes_ No_ X_ S_
NC10	Is preference for peer group leadership established through configuration?		M	5.10.1, 5.10.1.3	Yes_ No_ X_ S_
NC11	Are all nodes configured to advertise a value less than Max Leadership minus GroupLeaderIncrement?		M	5.10.1.2.2	Yes_ No_ X_ S_
NC12	Is there at most one node selected in each peer group/partition to perform some functions of the LGN?		M	3.2.4, 5.11.1	Yes_ No_ X_ S_
NC13	Does each node in the parent peer group have a unique node ID?		M	5.11.1	Yes_ No_ X_ S_

15.1.3.30 Enhanced Status Enquiry (Annex R)³

<u>Item</u>	<u>Protocol Feature</u>	<u>Conditions for status</u>	<u>Status Pred.</u>	<u>Spec. Ref.</u>	<u>Support</u>
	<u>When supporting Enhanced Status Enquiry (OPT 16), does the IUT:</u>				
<u>R.1</u>	<u>When querying about multiple calls in a single STATUS ENQUIRY message, send the STATUS ENQUIRY message with the Global call reference?</u>	<u>OPT 16</u> <u>NOT OPT 16</u>	<u>M</u> <u>N/A</u>	<u>Annex R,</u> <u>18.4</u>	<u>Yes No</u> <u>X S</u>
<u>R.2</u>	<u>When querying about multiple calls in a single STATUS ENQUIRY message, include the Reference list information element containing a list of up to 1000 call reference values?</u>	<u>OPT 16</u> <u>NOT OPT 16</u>	<u>M</u> <u>N/A</u>	<u>Annex R,</u> <u>18.4</u>	<u>Yes No</u> <u>X S</u>
<u>R.3</u>	<u>When querying about multiple calls in a single STATUS ENQUIRY message, start timer T322 for each call reference included in the Reference list information element?</u>	<u>OPT 16</u> <u>NOT OPT 16</u>	<u>M</u> <u>N/A</u>	<u>Annex R,</u> <u>18.4</u>	<u>Yes No</u> <u>X S</u>
<u>R.4</u>	<u>When receiving a STATUS ENQUIRY message on the Global call reference and the message contains a Reference list information element, which contains a list of call references, respond with a single STATUS message, which:</u> <ul style="list-style-type: none"> • <u>Uses the Global call reference in the Call reference information element.</u> • <u>Contains call state information for all or a subset of the call references specified in the received Reference list information element.</u> • <u>Contains one or more Call state information elements, at most one per state.</u> • <u>For Each Call state information element contains all or a subset of the call references that are specified in the received Reference list information element, and that are in the state specified in this Call state information element.</u> • <u>Contain a Cause information element with cause No. 30, "response to STATUS ENQUIRY".</u> 	<u>OPT 16</u> <u>NOT OPT 16</u>	<u>M</u> <u>N/A</u>	<u>Annex R,</u> <u>18.4</u>	<u>Yes No</u> <u>X S</u>

<u>Item</u>	<u>Protocol Feature</u>	<u>Conditions for status</u>	<u>Status Pred.</u>	<u>Spec. Ref.</u>	<u>Support</u>
	<u>When supporting Enhanced Status Enquiry (OPT 16), does the IUT:</u>				
<u>R.5</u>	<p><u>When a STATUS message is received for a point-to-multipoint call and the message contains one or more Endpoint state information elements that contain one or more endpoint reference values present in the corresponding STATUS ENQUIRY message, apply the following:</u></p> <ul style="list-style-type: none"> • <u>For each Endpoint state information element, follows the same procedure as if it had received one STATUS message for each of the endpoint references listed in the Endpoint state information element with an Endpoint state information element indicating the same party-state as in this received Endpoint state information element and with the same Cause and Call state information elements as in the received STATUS message?</u> • <u>For each endpoint reference not present in any Endpoint state information element of the STATUS message, but included in the Reference list information element in the corresponding STATUS ENQUIRY message:</u> <ul style="list-style-type: none"> • <u>Stop timer T322 and re-initiates the status enquiry procedures without counting this re-initiation as a retransmission, if the received STATUS message contains at least one call reference value present in the sent STATUS ENQUIRY?</u> • <u>Keep timer T322 running, if the received STATUS message does not contain at least one call reference value present in the sent STATUS ENQUIRY?</u> 	<p><u>OPT 16</u></p> <p><u>NOT OPT 16</u></p>	<p><u>M</u></p> <p><u>N/A</u></p>	<p><u>Annex R,</u></p> <p><u>18.4</u></p>	<p><u>Yes No</u></p> <p><u>X S</u></p>
<u>R.6</u>	<u>When querying about multiple parties of a point-to-multipoint call in a single STATUS ENQUIRY message, include the Reference list information element containing a list of up to 1000 endpoint reference values?</u>	<p><u>OPT 16</u></p> <p><u>NOT OPT 16</u></p>	<p><u>M</u></p> <p><u>N/A</u></p>	<p><u>Annex R,</u></p> <p><u>18.5</u></p>	<p><u>Yes No</u></p> <p><u>X S</u></p>
<u>R.7</u>	<u>When querying about multiple parties of a point-to-multipoint call in a single STATUS ENQUIRY message, start timer T322 for endpoint reference included in the Reference list information element?</u>	<p><u>OPT 16</u></p> <p><u>NOT OPT 16</u></p>	<p><u>M</u></p> <p><u>N/A</u></p>	<p><u>Annex R,</u></p> <p><u>18.5</u></p>	<p><u>Yes No</u></p> <p><u>X S</u></p>

<u>Item</u>	<u>Protocol Feature</u>	<u>Conditions for status</u>	<u>Status Pred.</u>	<u>Spec. Ref.</u>	<u>Support</u>
	<u>When supporting Enhanced Status Enquiry (OPT 16), does the IUT:</u>				
<u>R.8</u>	<p><u>When receiving a STATUS ENQUIRY message for a point-to-multipoint call and the message contains a Reference list information element, which contains a list of endpoint references, respond with a single STATUS message, which:</u></p> <ul style="list-style-type: none"> • <u>Contains a Call state information element with the call state of the point-to-multipoint call.</u> • <u>Contains party state information for all or a subset of the endpoint references specified in the received Reference list information element.</u> • <u>Contains one or more Endpoint state information elements, at most one per party state.</u> • <u>For Each Endpoint state information elements contains all or a subset of the endpoint references that are specified in the received Reference list information element, and that are in the state specified in this Endpoint state information element.</u> • <u>Contains a Cause information element with cause No. 30, "response to STATUS ENQUIRY".</u> 	<u>OPT 16</u> <u>NOT OPT 16</u>	<u>M</u> <u>N/A</u>	<u>Annex R,</u> <u>18.5</u>	<u>Yes No</u> <u>X S</u>
<u>R.9</u>	<p><u>When a STATUS message is received for a point-to-multipoint call and the message contains one or more Endpoint state information elements that contain one or more endpoint reference values present in the corresponding STATUS ENQUIRY message, apply the following:</u></p> <ul style="list-style-type: none"> • <u>For each Endpoint state information element, follows the same procedure as if it had received one STATUS message for each of the endpoint references listed in the Endpoint state information element with an Endpoint state information element indicating the same party-state as in this received Endpoint state information element and with the same Cause and Call state information elements as in the received STATUS message.</u> • <u>For each endpoint reference not present in any Endpoint state information element of the STATUS message, but included in the Reference list information element in the corresponding STATUS ENQUIRY message,</u> <ul style="list-style-type: none"> • <u>Stop timer T322 and re-initiates the status enquiry procedures without counting this re-initiation as a retransmission, if the received STATUS message contains at least one endpoint reference value present in the sent STATUS ENQUIRY?</u> • <u>Keep T322 running, if the received STATUS message does not contain at least one endpoint reference value present in the sent STATUS ENQUIRY?</u> 	<u>OPT 16</u> <u>NOT OPT 16</u>	<u>M</u> <u>N/A</u>	<u>Annex R,</u> <u>18.5</u>	<u>Yes No</u> <u>X S</u>

<u>Item</u>	<u>Protocol Feature</u>	<u>Conditions for status</u>	<u>Status Pred.</u>	<u>Spec. Ref.</u>	<u>Support</u>
	<u>When supporting Enhanced Status Enquiry (OPT 16), does the IUT:</u>				
<u>R.10</u>	<u>When either:</u> <ul style="list-style-type: none"> • <u>a STATUS ENQUIRY message was sent with a Reference list information element containing call references and a STATUS message is received with cause No. 30, “response to STATUS ENQUIRY” and a Call state information element that does not contain a list of call references, or</u> • <u>a STATUS ENQUIRY message was sent with a Reference list information element containing endpoint references and a STATUS message is received with cause No. 30, “response to STATUS ENQUIRY” and no Endpoint state information element.</u> <u>Does the IUT revert to the status enquiry procedure specified in section 6.5.6.11 or section 6.6 §9.5.11/Q.2971 without the extensions specified for the Enhanced Status Enquiry Procedures ?</u>	<u>OPT 16</u> <u>NOT OPT 16</u>	<u>M</u> <u>N/A</u>	<u>Annex R,</u> <u>18.6</u>	<u>Yes No</u> <u>X S</u>

15.1.3.31 Explicitly Routed Calls (Annex S)³

<u>Item</u>	<u>Protocol Feature</u>	<u>Conditions for status</u>	<u>Status Pred.</u>	<u>Spec. Ref.</u>	<u>Support</u>
<u>S.1</u>	<u>If the DTL stack appended to the SETUP or ADD PARTY message by the DTL originator is an explicit route DTL, is the DTL stack encoded as described in Section 7.2.1.1?</u>	<u>OPT_17</u> <u>NOT OPT_17</u>	<u>M</u> <u>N/A</u>	<u>Annex S</u>	<u>Yes No</u> <u>X S</u>
<u>S.2</u>	<u>In the top explicit routed Designated transit list information element in the DTL stack received by the IUT acting as an entry border node, if the logical node identifier indicated by the current transit pointer is the lowest node ID of the IUT, are the procedures from Section 7.2.3 followed?</u>	<u>OPT_17</u> <u>NOT OPT_17</u>	<u>M</u> <u>N/A</u>	<u>Annex S</u>	<u>Yes No</u> <u>X S</u>
<u>S.3</u>	<u>If the current transit pointer in the top explicit routed Designated transit list information element in the DTL stack received by the IUT is a lowest level node Id of an adjacent node in another peer group, does the IUT progress the connection to that transit, using the specified logical port, if any?</u>	<u>OPT_17</u> <u>NOT OPT_17</u>	<u>M</u> <u>N/A</u>	<u>Annex S</u>	<u>Yes No</u> <u>X S</u>
<u>S.4</u>	<u>If the current transit pointer in the top explicit routed Designated transit list information element in the DTL stack received by the IUT is a lowest level node Id of an adjacent node in another peer group, but the specified logical port does not correspond to a logical link to the next transit, does the IUT crankback the call with crankback cause #128 "next node unreachable" and cause #2 "no route to specified transit network" or cause #3 "no route to destination"?</u>	<u>OPT_17</u> <u>NOT OPT_17</u>	<u>M</u> <u>N/A</u>	<u>Annex S</u>	<u>Yes No</u> <u>X S</u>
<u>S.5</u>	<u>If the current transit pointer in the top explicit routed Designated transit list information element in the DTL stack received by the IUT is at the end of the DTL and there are DTLs remaining on the stack, then if the logical node identifier indicated by the current transit pointer of the next designated transit list is the node ID of a lowest level node adjacent to the current node (either in the same peer group or in a different peer group) is the top DTL information element popped and the procedures of Section 7.3 (as modified by Annex S) performed starting at new step (a)?</u>	<u>OPT_17</u> <u>NOT OPT_17</u>	<u>M</u> <u>N/A</u>	<u>Annex S</u>	<u>Yes No</u> <u>X S</u>

15.1.3.32 Support of the OAM Traffic Descriptor (Annex T)³

<u>Item</u>	<u>Protocol Feature</u>	<u>Conditions for status</u>	<u>Status Pred.</u>	<u>Spec. Ref.</u>	<u>Support</u>
	<u>When supporting OAM Traffic descriptor (OPT 18), does the IUT:</u>				
<u>T.1</u>	<u>When it provides traffic shaping and cannot support the user request to avoid aggregate ATM user information and end-to-end OAM F5 flow shaping, clear the call and return cause No. 63, "service or option not available, unspecified"?</u>	<u>OPT 18</u> <u>NOT OPT 18</u>	<u>M</u> <u>N/A</u>	<u>Annex T</u>	<u>Yes No</u> <u>X S</u>
<u>T.2</u>	<u>When it provides traffic shaping and can support the user request to avoid aggregate ATM user information and end-to-end OAM F5 flow shaping, shape only the user data information flow on the basis of its specific traffic descriptor letting the OAM information flow by-pass the shaping function?</u>	<u>OPT 18</u> <u>NOT OPT 18</u>	<u>M</u> <u>N/A</u>	<u>Annex T</u>	<u>Yes No</u> <u>X S</u>
<u>T.4</u>	<u>When it receives an OAM traffic descriptor information element in a CONNECT message, transfer transparently this OAM traffic descriptor information element in the forwarded connection indication?</u>	<u>OPT 18</u> <u>NOT OPT 18</u>	<u>M</u> <u>N/A</u>	<u>Annex T</u>	<u>Yes No</u> <u>X S</u>
<u>T.5</u>	<u>Set the action indicator (bits 1-3 of octet 2) to " Discard information element, proceed and report status" or "Discard information element and proceed", the IE instruction flag field (bit 5 of octet 2) to "follow explicit instruction" and the pass along request field (bit 4 of octet 2) to "pass along request" for the OAM traffic descriptor information element?</u>	<u>OPT 18</u> <u>NOT OPT 18</u>	<u>M</u> <u>N/A</u>	<u>Annex T</u>	<u>Yes No</u> <u>X S</u>

15.2 Frame Relay Soft PVC Extension PICS Proforma ⁴

The following PICS are in addition to those specified for Soft PVCs in Sections [15.1.3.27](#) and [15.1.3.28](#) above.

15.2.1 Roles

Item Number	Item Description	Status	Predicate	Reference	Support
SPVC-PP	Does the IUT support the frame relay Soft PVC endpoint feature for point-to-point connections?	<u>O</u>		9	Yes [] No []

15.2.2 Major Capabilities

Item Number	Item Description	Status	Predicate	Reference	Support
SPVC-MC.1	Is the IUT capable of initiating a Soft PVC connection to a frame relay endpoint?	<u>M</u>	SPVC-PP	9	Yes [] No []
SPVC-MC.2	Is the IUT capable of initiating a Soft PVC connection from a frame relay endpoint?	<u>O</u>	SPVC-PP	9	Yes [] No []
SPVC-MC.3	Is the IUT capable of terminating a Soft PVC connection to a frame relay endpoint?	<u>O</u>	SPVC-PP	9	Yes [] No []
SPVC-MC.4	Is the IUT capable of terminating a Soft PVC connection from a frame relay endpoint?	<u>M</u>	SPVC-PP	9	Yes [] No []

15.2.2.1 Information Element Encoding

Item	Protocol Feature	Status	Predicate	Reference	Support
SPVC-E.1	Is the Calling party Soft PVPC or PVCC information element with a DLCI coded as shown in Figure 6-29 ?	<u>M</u>	SPVC-MC.2	6.4.6.1	Yes [] No []
SPVC-E.2	Is the Called party Soft PVPC or PVCC information element with a DLCI coded as shown in Figure 6-28 ?	<u>M</u>	SPVC-MC.1	6.4.6.2	Yes [] No []

15.2.2.2 Soft PVC procedures for Point-to-Point connections

Item	Procedures Feature	Status	Predicate	Reference	Support
SPVC-PPP.1	If the received DLCI is set to "required value" and the requested DLCI is not available, does the IUT send a RELEASE COMPLETE message with PNNI specific cause #34 "requested called party Soft PVPC/PVCC not available"?	<u>M</u>	SPVC-MC.3	9	Yes [] No []
SPVC-PPP.2	If a Called party Soft PVPC or PVCC information element is received at a	<u>M</u>	SPVC-MC.3	9	Yes [] No []

	<u>frame relay Network Interface (NI), with selection type coded as “Any value” and no DLCI is available, does the IUT send a RELEASE COMPLETE message with ITU-T specific cause #34 “no circuit/channel available”?</u>				
<u>SPVC-PPP.3</u>	<u>If the received DLCI is set to “Required value” and no DLCI is specified, does the IUT send a RELEASE COMPLETE message with cause #100 “Invalid information element contents”?</u>	<u>M</u>	<u>SPVC-MC.3</u>	<u>9</u>	<u>Yes[] No[]</u>
<u>SPVC-PPP.4</u>	<u>If a Called party Soft PVPC or PVCC information element is received at a frame relay interface, with selection type coded as “Any value” and a DLCI is present, does the IUT ignore the DLCI?</u>	<u>M</u>	<u>SPVC-MC.3</u>	<u>9</u>	<u>Yes[] No[]</u>
<u>SPVC-PPP.5</u>	<u>If the CONNECT message contains the Called party Soft PVPC/PVCC information element with a DLCI, is the DLCI value of the PVCC segment between the called connecting point and the user passed to the management entity?</u>	<u>M</u>	<u>SPVC-MC.1</u>	<u>9</u>	<u>Yes[] No[]</u>
<u>SPVC-PPP.6</u>	<u>For the last PVCC segment, does the calling connecting point indicate for the called frame relay endpoint Soft PVCC either</u> <u>- any DLCI or</u> <u>- Required DLCI ?</u>	<u>M</u>	<u>SPVC-MC.1</u>	<u>9</u>	<u>Yes[] No[]</u>
<u>SPVC-PPP.7</u>	<u>If the called party identifies a cell relay interface and the Called party Soft PVPC or PVCC information element specifies a DLCI, does the IUT send a RELEASE COMPLETE message with cause #88 “incompatible destination”?</u>	<u>M</u>		<u>9</u>	<u>Yes[] No[]</u>
<u>SPVC-PPP.8</u>	<u>If the called party identifies a frame relay interface and the Called party Soft PVPC or PVCC information element specifies a VPCI or VPCI/VCI does the IUT send a RELEASE COMPLETE message with cause #88 “incompatible destination”?</u>	<u>M</u>	<u>SPVC-MC.3</u>	<u>9</u>	<u>Yes[] No[]</u>
<u>SPVC-PPP.9</u>	<u>If a Called party Soft PVPC or PVCC information element is received at a cell relay interface, with selection type coded as “Any value” and no VPCI or VPCI/VCI is available, does the IUT send a RELEASE COMPLETE message with ITU-T cause #34 “no circuit/channel available”?</u>	<u>M</u>		<u>9</u>	<u>Yes[] No[]</u>

<u>SPVC-PPP.10</u>	<u>If a Called party Soft PVPC or PVCC information element is received at a cell relay interface, with selection type coded as “Any value” and a VPCI or VPCI/VCI is present, does the IUT ignore the VPCI or VPCI/VCI?</u>	<u>M</u>		<u>2</u>	<u>Yes[] No[]</u>
<u>SPVC-PPP.11</u>	<u>If the received VPCI or VPCI/VCI is set to “Required value” and no VPCI or VPCI/VCI is specified, does the IUT send a RELEASE COMPLETE message with cause #100 “Invalid information element contents”?</u>	<u>M</u>		<u>2</u>	<u>Yes[] No[]</u>
<u>SPVC-PPP.12</u>	<u>If the IUT is not the termination point of the Soft PVC, does it pass along unchanged Calling and Called party Soft PVPC or PVCC information elements containing a DLCI?</u>	<u>M</u>		<u>2</u>	<u>Yes[] No[]</u>
<u>SPVC-PPP.13</u>	<u>If the IUT is not the termination point of the Soft PVC, does it pass along unchanged Calling and Called party Soft PVPC or PVCC information elements containing unrecognized content?</u>	<u>M</u>		<u>2</u>	<u>Yes[] No[]</u>

16. Annexes J to P³

These annexes can be found in [8].

17. Annex Q: PNNI 1.1 support of administrative boundaries³

This section contains changes to existing PNNI addenda to support PNNI interfaces as administrative boundaries within a single PNNI routing domain.

17.1 Procedures for NCCI support at PNNI interfaces between administrative domains

Support for PNNI interfaces between administrative domains is added to [18] as follows:

A new section 3.1.4 is added, with contents identical to those of section 4.1.1. The following note is added at the end of this section:

Note: Support for the Network call correlation identifier information element in the CONNECT message is only applicable at PNNI interfaces between administrative domains.

A new section 3.3 is added as follows:

3.3 NCCI Procedures for PNNI Interfaces between Administrative Domains

The following procedures shall apply at PNNI interfaces between administrative domains, instead of the procedures specified in section 3.2.

In this section, the term SETUP message refers to both the CO-BI SETUP message defined in GSS v1.0 and the SETUP message defined in PNNI 1.0.

3.3.1 Procedures for Point-to-Point calls

The procedures specified in section 4.2.1 shall apply, changing “AINI” to “PNNI”.

3.3.2 Procedures for Point-to-Multipoint calls

3.3.2.1 Setup of the Initial party

The procedures specified in section 4.2.2.1 shall apply, changing “AINI” to “PNNI” and changing “section 4.2.1” to “section 3.3.1”.

3.3.2.2 Adding a party

The procedures specified in section 4.2.2.2 shall apply, changing “AINI” to “PNNI”.

3.3.3 Storing the NCCI

The procedures specified in section 4.2.3 shall apply.

17.2 Procedures for UBR with MDCR support at PNNI interfaces between administrative domains

Support for PNNI interfaces between administrative domains is added to [20] as follows:

A new heading is added after the section 5.2 heading and before the text currently included in section 5.2, as follows:

5.2.1 Procedures at a PNNI interface within one administrative domain

A new section 5.2.2 is added after the text currently included in section 5.2, as follows:

5.2.2 Procedures at a PNNI interface between administrative domains

The procedures specified in section 6.1.2 shall apply, changing “AINI” to “PNNI”, in addition to the procedures specified in section 5.2.1.

17.3 Procedures for BCS support at PNNI interfaces between administrative domains

Support for PNNI interfaces between administrative domains is added to [22] as follows:

A new heading is added after the section 4.2 heading and before the text currently included in section 4.2, as follows:

4.2.1 Procedures at a PNNI interface within one administrative domain

A new section 4.2.2 is added after the text currently included in section 5.2, as follows:

4.2.2 Procedures at a PNNI interface between administrative domains

The procedures specified in section 5.1.2 shall apply, changing “AINI” to “PNNI”.

18. Annex R: Enhanced status enquiry³

18.1 Introduction

This Annex specifies extensions to the Status Enquiry mechanism such that a single STATUS ENQUIRY message can be used to query for the status of up to 1000 calls or to query for the status of up to 1000 parties of a call. A single STATUS message will be returned to report the call or party state for all or a subset of the calls/parties identified in the STATUS ENQUIRY message.

This capability is useful when a PNNI node wants to query the state of multiple calls or parties (e.g. as a result of a Signalling AAL error – see Sections 6.5.6.9 and 6.5.6.10) on a PNNI interface.

18.2 Scope

This capability allows a PNNI node to send a single STATUS ENQUIRY message on a PNNI interface to:

- Query the call state of up to 1000 calls, and to
- Query the party state of up to 1000 parties of a point-to-multipoint call.

This capability does not remove the restriction of only one outstanding STATUS ENQUIRY message for a call reference.

On receipt of such a query, a PNNI node shall be able to respond with a single STATUS message conveying the requested state information for all or only a subset of the calls/parties identified in the STATUS ENQUIRY message.

A PNNI node shall be able to process a STATUS response for all or a subset of the calls/parties identified in the STATUS ENQUIRY message which was sent.

In order to operate correctly, this capability must be supported by both sides of an interface. When the peer signalling entity does not support this capability, the signalling entity initiating the procedures shall be able to detect it and the status enquiry procedures of Section 6.5.6.11 or Section 6.6 §9.5.11/Q.2971 without the extensions of this Annex shall be used.

18.3 Coding

18.3.1 Messages

18.3.1.1 STATUS

Figure 6-9 shall apply with the following changes:

- Modify the lengths of the Call state and Endpoint state information elements to 5-3008.
- Replace Note 2 by the following:

Note 2 - Included when responding to a status enquiry about a single party state, when responding to a status enquiry about multiple party states, or at any time to report certain error conditions in the point-to-multipoint procedures. ~~Included when the Endpoint reference information element is included.~~³

- Add the following Note to the type column of the Call state information element

Note 4 - The Call state information element may be repeated – one occurrence of this information element may be present for each call state.

- Add the following note to the type column of the Endpoint state information element

Note 5 - Endpoint state information element may be repeated – one occurrence of this information element may be present for each party state.

18.3.1.2 STATUS ENQUIRY

Figure 6-10 shall apply with the following changes:

- Add the following information element and corresponding note:

<u>Information Element</u>	<u>Reference</u>	<u>Type</u>	<u>Length</u>
<u>Reference list</u>	<u>18.3.2.1</u>	<u>O(2)</u>	<u>6-3007</u>

Note 2 - This information element is included when querying for the state of multiple calls or multiple parties of a call.

- Add the following note to the type column of the Call reference information element:

Note 3 - This message may be sent with the Global call reference.

18.3.2 Information elements**18.3.2.1 Call State**

See Section A12.3.2.1 of the UNI Signalling 4.1 specification.

18.3.2.2 Endpoint State

See Section A12.3.2.2 of the UNI Signalling 4.1 specification.

18.3.2.3 Reference list

See Section A12.3.2.3 of the UNI Signalling 4.1 specification.

18.4 Procedure for Point-to-point calls

The procedures of Section 6.5.6.11 shall apply with the following additions:

When it is necessary to query the status of multiple calls (e.g. when a Signalling AAL connection reset or release occurs - see Section 6.5.6.9 and Section 6.5.6.10), the following extensions may be used to query the status of up to 1000 calls:

- The STATUS ENQUIRY message shall use the Global call reference in the Call reference information element.
- The STATUS ENQUIRY message shall contain a Reference list information element containing a list of up to 1000 call reference values.
- Timer T322 shall be started for each call reference on the list.

The above extensions may also apply when the status enquiry procedures are invoked as a result of expiry of timer T322. Specifically, when timer T322 expires, a STATUS ENQUIRY message may be sent using the call reference of the call, or the status of the call (and possibly the status of other calls) may be queried using the above extensions.

When a STATUS ENQUIRY message is received on the Global call reference and the message contains a Reference list information element that contains a list of call references, the receiver shall respond with a single STATUS message, which:

- Shall use the Global call reference in the Call reference information element.
- Shall contain call state information for all or a subset of the call references specified in the received Reference list information element.
- Shall contain one or more Call state information elements, at most one per state.
- Each Call state information element shall contain all or a subset of the call references that are specified in the received Reference list information element, and that are in the state specified in this Call state information element.

For example, if all the call references are in either the Active state or in the Null state then two call state information elements would be included – one with the call state indicating Active state followed by a list of all the call references from the Reference list information element that are in the Active state and – a second one with the call state indicating Null state followed by a list of all the call references from the Reference list information element that are in the Null state.

- Shall contain a Cause information element with cause No. 30, “response to STATUS ENQUIRY”.

The procedures of Section 6.5.6.12 shall apply with the following additions:

When a STATUS message is received on the Global call reference and the message contains one or more Call state information elements that contain one or more call reference values, the following shall apply:

- For each Call state information element the receiver shall follow the same procedure as if it had received one STATUS message for each of the call references listed in the Call state information element with a Call state information element indicating the same state as in this received Call state information element and with the same Cause information element as in the received STATUS message.
- For each call reference not present in any Call state information element of the STATUS message, but included in the Reference list information element in the corresponding STATUS ENQUIRY message, the receiver shall:
 - Stop timer T322 and may re-initiate the status enquiry procedures, if the received STATUS message contains at least one call reference value present in the corresponding STATUS ENQUIRY. In this case, the re-initiation of the status enquiry procedure shall not be counted as a retransmission.
 - Keep timer T322 running if the received STATUS message does not contain at least one call reference value present in the corresponding STATUS ENQUIRY.

18.5 Point-to-multipoint Procedures

18.5.1 Call state enquiry

The procedures of Section 18.4 shall apply.

18.5.2 Party state enquiry

The procedures of Section 6.6 §9.5.11/Q.2971 shall apply with the following additions:

When it is necessary to query the status of multiple parties (e.g. when a Signalling AAL connection reset or release occurs - see Section 6.6 §9.5.9/Q.2971 and Section 6.6 §9.5.10/Q.2971), the following extensions may be used to query the status of up to 1000 parties of the same call:

- The STATUS ENQUIRY message shall contain a Reference list information element containing a list of up to 1000 endpoint reference values.
- Timer T322 shall be started for each endpoint reference on the list.

The above extensions may also apply when the status enquiry procedures are invoked as a result of expiry of timer T322. Specifically, when timer T322 expires, a STATUS ENQUIRY message may be sent using the endpoint reference of the party or the status of the party (and possibly the status of other parties) may be queried using the above extensions.

When a STATUS ENQUIRY message is received for a point-to-multipoint call and the message contains a Reference list information element that contains a list of endpoint references, the receiver shall respond with a single STATUS message, which:

- Shall contain a Call state information element with the call state of the point-to-multipoint call.
- Shall contain party state information for all or a subset of the endpoint references specified in the received Reference list information element.
- Shall contain one or more Endpoint state information elements, at most one per party state.
- Each Endpoint state information elements shall contain all or a subset of the endpoint references that are specified in the received Reference list information element, and that are in the state specified in this Endpoint state information element.

For example, if all of the endpoint references are in either the Active party-state or in the Null party-state then two endpoint state information elements would be included – one with the endpoint state indicating Active party-state and a list of all the endpoint references from the Reference list information element that are in the Active party-state and – a second one with the endpoint state indicating Null party-state and a list of all the endpoint references from the Reference list information element that are in the Null party-state).

- Shall contain a Cause information element with cause No. 30, “response to STATUS ENQUIRY”.

The procedures of Section 6.6 §9.5.12/O.2971 shall apply with the following additions:

When a STATUS message is received for a point-to-multipoint call and the message contains one or more Endpoint state information elements that contain one or more endpoint reference values, the following shall apply:

- For each Endpoint state information element, the receiver shall follow the same procedure as if it had received one STATUS message for each of the endpoint references listed in the Endpoint state information element with an Endpoint state information element indicating the same party-state as in this received Endpoint state information element and with the same Cause and Call state information elements as in the received STATUS message.
- For each endpoint reference not present in any Endpoint state information element of the STATUS message, but included in the Reference list information element in the corresponding STATUS ENQUIRY message, the receiver shall:
 - Stop timer T322 and may re-initiate the status enquiry procedures, if the received STATUS message contains at least one endpoint reference value present in the corresponding STATUS ENQUIRY. In this case, the re-initiation of the status enquiry procedure shall not be counted as a retransmission.
 - Keep timer T322 running if the received STATUS message does not contain at least one endpoint reference value present in the corresponding STATUS ENQUIRY.

18.6 Compatibility with nodes not supporting the capability

When a STATUS ENQUIRY message with the extensions specified in this Annex is received by a node that does not support the optional procedures of this Annex, the Reference list information will be treated as an unrecognized information element and the node will respond with a STATUS message with cause No. 30, “response to STATUS ENQUIRY”. If the Reference list information element in the STATUS ENQUIRY message contained call references, then the Call state information element in the STATUS message does not contain a list of call references. If the Reference list information element in the STATUS ENQUIRY message contained endpoint references, then there will be no Endpoint state information element in the STATUS message.

The node receiving the STATUS ENQUIRY message might also respond with a second STATUS message to report the unrecognized information element. This second STATUS message can be prevented by setting the instruction indicators of the Reference list information element as follows:

- The IE instruction flag field (bit 5 of octet 2) set to "follow explicit instructions", and
- The action indicator (bits 1-3 of octet 2) set to "discard information element and proceed".

When either:

- a STATUS ENQUIRY message is sent with a Reference list information element containing call references and a STATUS message is received with cause No. 30, “response to STATUS ENQUIRY” and a Call state information element that does not contain a list of call references, or
- a STATUS ENQUIRY message is sent with a Reference list information element containing endpoint references and a STATUS message is received with cause No. 30, “response to STATUS ENQUIRY” and no Endpoint state information element,

then, the receiver shall revert to the status enquiry procedure specified in Section 6.5.6.11 or Section 6.6 §9.5.11/O.2971 without the extensions specified in this Annex.

19. Annex S: Explicitly routed calls³

The procedures of Section 7 shall apply with the following modifications:

- *Add the following paragraph before the first paragraph of Section 7.2.1:*

The DTL originator may compute a path for an arriving call or may optionally support the ability to have a path pre-provisioned from network management for some types of calls (e.g. Soft PVCs). The case where a path is pre-provisioned is described in Section 7.2.1.1. Following are the procedures for the case where the node computes a path.

- *Add the following new Section:*

7.2.1.1 Pre-provisioned DTLs

As an option, a DTL originator may support pre-provisioned DTLs for certain network applications.

The pre-provisioned DTL may contain either:

1. A hierarchically complete list of logical nodes and optionally logical links, producing a DTL stack as described in Section 7.2.1 or
2. A list of lowest level nodes and optionally logical links including nodes from different peer groups. This type of DTL is referred to as an explicit route DTL.

Case #1 could be used, for example, to steer calls through peer groups that PNNI routing would not normally choose. Case #2 can be used, for example, to provide path diversity over physical links and transmission facilities to ensure that no single network failure affects both paths, as described in Section 4.7.1.

In case #1, the DTL shall be encoded as a hierarchically complete DTL stack as described in Section 7.2.1. Calls originated with this type of DTL can be progressed by PNNI nodes that do not support this feature.

In case #2, the explicit route shall be encoded as a last in, first out DTL stack as described in Section 7.2.1, except that each DTL information element shall only include lowest level nodes and optionally logical links along the path from the source to the destination. The complete DTL stack shall contain a strict source route comprised of all lowest level nodes from the source node to the destination node. Each information element may include lowest level nodes from different peer groups. Nodes adjacent in the DTL must be topologically adjacent to each other in the network. Having nodes from different peer groups in the same DTL information element is supported to allow an explicitly routed call to traverse a large number of transit nodes.

- *Modify the first paragraph of Section 7.2.2 as follows:*

When a call enters a peer group, the border node shall examine the top designated transit list information element in the SETUP or ADD PARTY message. If the node supports transiting explicit route DTLs, and if the node identifier indicated by the current transit pointer is the same as that node's own lowest level node identifier, then the procedures of Section 7.2.3 shall apply. Otherwise, if the logical node identifier indicated by the current transit pointer is not the same as the node ID of the border node's ancestor at the level of the common peer group for the receiving link, then the call shall be cleared with cause #41 "temporary failure" and optionally cranked back with either (i) a blocked transit type of "call or party has been blocked at the succeeding end of this interface" and crankback cause #128 "next node unreachable", or (ii) crankback cause #160 "DTL transit not my node ID" and the DTL transit listed as the blocked node. If the logical port identifier is not set to 0, it indicates the logical port to be used to progress the call when it exits the peer group.

- Add a new item before item a) in Section 7.3 (change the existing a) and b) to b) and c), respectively):
 - a) Indicates a transit which is a lowest level node Id of an adjacent node in another peer group and the node supports transiting explicit route DTLs, the connection shall be progressed to that transit, using the specified logical port, if any. However,
 - if the specified logical port does not correspond to a logical link to the next transit, then the call shall be cranked back with crankback cause #128 “next node unreachable” and cause #2 “no route to specified transit network” or cause #3 “no route to destination”.³

- Modify the 5th paragraph in Section 7.3 as follows (reference to step a) in the added text is to the new item a) added above):

If the current transit pointer indicates the end of the DTL, the DTL shall be popped from the stack, saving the level of the DTL as the path scope if this is the last DTL on the stack. If there are any DTLs remaining on the stack, the node shall examine the next designated transit list. If the logical node identifier indicated by the current transit pointer of the next designated transit list is the node ID of a lowest level node adjacent to the current node (either in the same peer group or in a different peer group) and this node supports transiting explicit route DTLs, then perform the procedures of Section 7.3 starting at step (a) without advancing the current transit pointer. If the logical node identifier indicated by the current transit pointer of the next designated transit list is not a node ID of one of the border node’s ancestors, then the call shall be cleared with cause #41 "temporary failure" and optionally cranked back with crankback cause #160 "DTL transit not my node ID". If the logical port identifier is not set to 0 and does not contain all logical ports found during previous recursions of these procedures (i.e., specified in DTLs at lower levels of the hierarchy), such that there is conflicting information as to which port to use to progress the call, then the call shall be cleared with cause #41 "temporary failure". If the logical port identifier is not set to 0 and no logical port has been specified yet, then the port identifier indicates the logical port to be used to progress the call. The first specific logical port which is found during these procedures (i.e., the one at the lowest level of hierarchy of those specified) is to be used to progress the call.

- Modify the pseudocode in Section 7.5 as follows:

The operations required to process the received stack of DTLs and to generate the new stack of DTLs are as follows:

- 1) receive a PNNI SETUP or ADD PARTY message.
- 2) extract a DTL stack from the SETUP or ADD PARTY message and initialize both OneAncestorIsRestrictedTransit and LowestLevelIsRestrictedTransit flags to FALSE.
- 3) does the current transit in the topmost DTL on the stack correspond to me at any level of the routing hierarchy?
 - a. yes: set the current node and current port (local variables) to the current transit in the topmost DTL on the stack.
 - b. no: abort, an error has occurred.
- 4) does the current node (from 3) correspond to me at the lowest possible level of the routing hierarchy?
 - a. yes: am I a restricted transit node (at the lowest level)?
 - a.1 yes: is the current transit pointer in the topmost DTL on the stack pointing to the last transit?
 - a.1.1 yes: set the LowestLevelExitBorderIsRestrictedTransit flag to TRUE and save my logical node identifier at the lowest level. goto 6
 - a.1.2 no: abort, an error has occurred
 - a.2 no: set the LowestLevelExitBorderIsRestrictedTransit flag to FALSE and goto 6.
 - b. no: am I at the corresponding hierarchy level a restricted transit node ?
 - b.1 yes: set the OneAncestorIsRestrictedTransit flag to TRUE and save my logical node identifier at the corresponding hierarchy level, and goto b.3.
 - b.2 no: set the OneAncestorIsRestrictedTransit flag to FALSE, and goto b.3.
 - b.3 is the current transit pointer referencing the last element in the DTL?
 - b.3.1 yes: are there any other DTLs lower down on the stack?
 - b.3.1.1 yes: check the next DTL down on the stack.
(Note: do *not* pop any DTLs off the stack at this stage.)
Does the current transit in the DTL correspond to me at any level of the routing hierarchy?

- 7) is the current transit pointer in the topmost DTL on the stack not pointing to the last transit and is the LowestLevelExitBorderIsRestrictedTransit flag set to TRUE ?
- a. yes: abort, an error has occurred.
 - b. no: is the current transit pointer referencing the last element in the DTL?
 - b.1. yes: is this the last DTL on the stack?
 - b.1.1 yes: you have arrived at a node that has direct reachability to the called party number or specified transit network. Set the path scope (a local variable) to the level of this DTL, then pop the DTL off the stack. The connectivity to the called party number or specified transit network must have scope higher than or equal to the path scope. Send a UNI SETUP message directly to the called party or specified transit network.
 - b.1.2 no: pop the DTL off the stack. Does the current transit in the next DTL on the stack correspond to me at any level of the routing hierarchy?
 - b.1.2.1 yes: is the output port set to zero (unspecified)?
 - b.1.2.1.1 yes: reset the output port to that of the current transit in this DTL. goto 7.
 - b.1.2.1.2 no: is the output port included within the current transit's port in this DTL?
 - b.1.2.1.2.1 yes: goto 7.
 - b.1.2.1.2.2 No: abort, an error has occurred.
 - b.1.2.2 no: does this node support transiting explicit route DTLs and does the current transit in the next DTL on the stack correspond to the node ID of a lowest level node adjacent to me (either in the same peer group or in a different peer group)?
 - b.1.2.2.1 yes: goto 10
 - b.1.2.2.2 no: abort, an error has occurred.
 - b.2 no: continue.
- 8) advance the current transit pointer in the topmost DTL on the stack.
- 9) put the resulting DTL stack back into the SETUP or ADD PARTY message.
- 10) send the PNNI SETUP or ADD PARTY message directly to the current transit listed in the topmost DTL on the stack, through the output port.

** The way to specify a path and convert the resulting path to a DTL stack can be described in many ways. These possible descriptions vary depending on where to draw the line between the routing algorithm and the specification of DTLs.

To summarize the algorithm, the main steps are as follows:

- determine current node (including current level of hierarchy) (step 3)
- determine target of path selection (step 4)
- determine route and push path onto stack of DTLs (step 5)
- determine output port (step 6)
- pop completed DTLs from stack (step 7)
- advance current transit pointer (step 8)

20. Annex T: Support of the OAM traffic descriptor³

The support of the OAM traffic descriptor information element is an optional feature of PNNI 1.1.

The OAM traffic descriptor information element may be included in the SETUP message by the calling user; however, its absence does not mean that there will be no OAM flow used within the call. If a node does not support this information element, it will treat the information element as an unrecognized information element.

20.1 Coding

20.1.1 Messages

20.1.1.1 SETUP

Figure 6-8 shall apply with the following changes:

- Add the following information element:

<u>Information Element</u>	<u>Reference</u>	<u>Type</u>	<u>Length</u>
<u>OAM traffic descriptor</u>	<u>20.1.2.1</u>	<u>O(1)</u>	<u>6</u>

20.1.1.2 CONNECT

Figure 6-5 shall apply with the following changes:

- Add the following information element:

<u>Information Element</u>	<u>Reference</u>	<u>Type</u>	<u>Length</u>
<u>OAM traffic descriptor</u>	<u>20.1.2.1</u>	<u>O(1)</u>	<u>6</u>

20.1.2 Information element

20.1.2.1 OAM traffic descriptor

See Section 4.5.24 of Q.2931.

20.2 Handling of the OAM traffic descriptor information element in the SETUP message

When the succeeding side receives a SETUP message with an OAM traffic descriptor, the node shall, as a minimum, transfer this information element and include it in the forwarded setup indication.

The use of ATM traffic shaping is optional (see the Traffic Management 4.1 specification, [14]). If no ATM traffic shaping is applied, the node shall transfer the Shaping indicator subfield of the OAM traffic descriptor information element transparently.

The Shaping indicator subfield shall be interpreted by a node if it applies ATM traffic shaping. A node which applies ATM traffic shaping but cannot support the request to avoid aggregate ATM user information and end-to-end OAM F5 flow shaping shall clear the call and return cause No. 63, "service or option not available, unspecified". In the case that separate shaping is indicated in the received OAM traffic descriptor information element, the node may shape only the user data information flow on the basis of its specific traffic descriptor, letting the OAM information flow bypass the shaping function, provided that the node can accommodate the resulting traffic incurred by the OAM cell stream. If, as an option, the node performs traffic shaping in conjunction with a Network Parameter Control (NPC) function, the node may perform user data and OAM F5 aggregate shaping or separate shaping, according to the requirement specified in the Shaping indicator field of the received OAM traffic descriptor information element.

The use of a received OAM traffic descriptor with regards to Call Admission Control (CAC), NPC and traffic shaping shall be as specified in the Traffic Management 4.1 specification, [14].

20.3 Handling of the OAM traffic descriptor information element in the CONNECT Message

When the preceding side receives an OAM traffic descriptor information element in a CONNECT message, it shall be transferred transparently in the forwarded connect indication.

20.4 Compatibility with nodes not supporting the capability

When a node which does not support the OAM traffic descriptor information element receives a message containing the OAM traffic descriptor information element, it will treat the information element as an unrecognized information element.

Nodes supporting the OAM traffic descriptor information element shall set the action indicator (bits 1-3 of octet 2) to "Discard information element, proceed and report status" or "Discard information element and proceed", the IE instruction flag field (bit 5 of octet 2) to "follow explicit instruction" and the pass along request field (bit 4 of octet 2) to "pass along request". With these settings, nodes that do not support the OAM traffic descriptor information element will treat the call as they would if the information element was not present.

21. Appendix A: Examples of Message Sequences

21.1 General

This section describes the relationship between the Call States, Connection Establishment/Release messages and timers used in the symmetric procedures.

21.2 Finite State Machine

Figure 21-1 shows the message sequence chart of PNNI for normal ATM connection establishment and release.

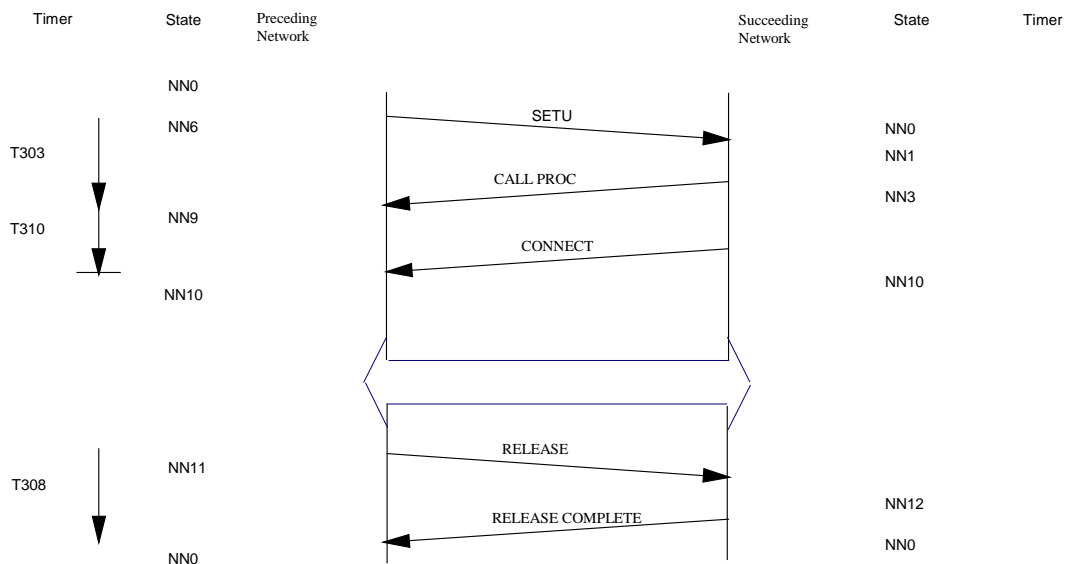

Figure 21-1 : PNNI Finite State Machine

21.3 Example of Message Sequences

The flows shown below describe, in a simplified manner, the initiation of a Call establishment and call clearing across multiple PNNIs.

21.3.1 Successful Call Establishment

Figure 21-2 shows an example of the message sequence across the PNNI when a call is initiated from TE X to TE Y for a successful call.

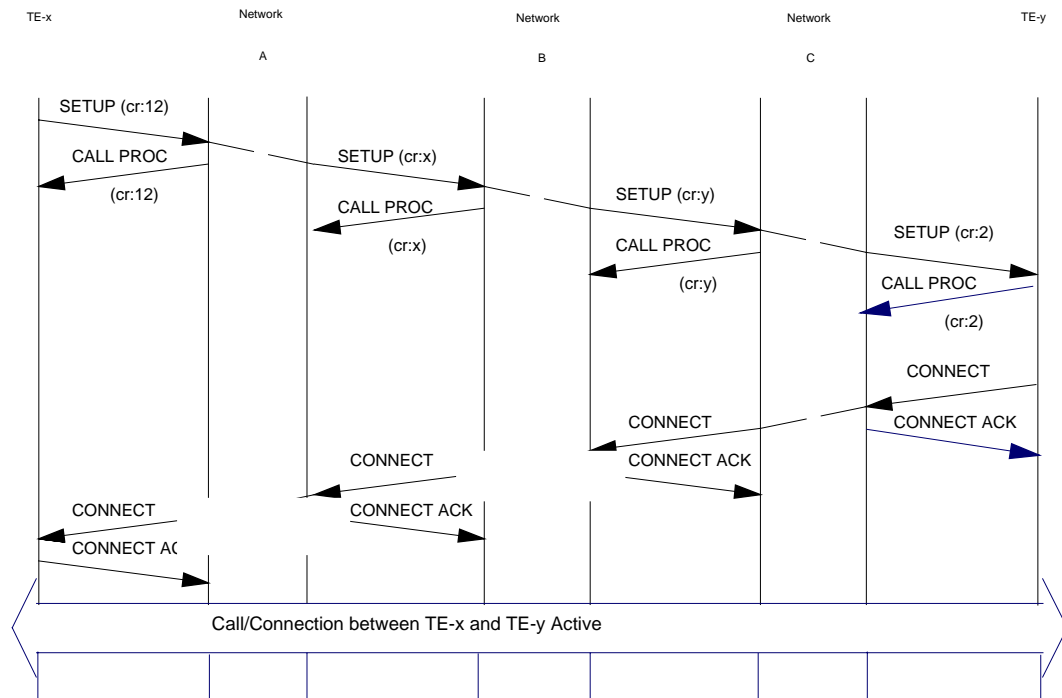

Figure 21-2 : Setup, successful call

21.3.2 Unsuccessful Call Establishment

Figure 21-3 shows an example of the message sequence across the PNNI when a call is initiated from TE X to TE Y for a unsuccessful call (called user rejection).

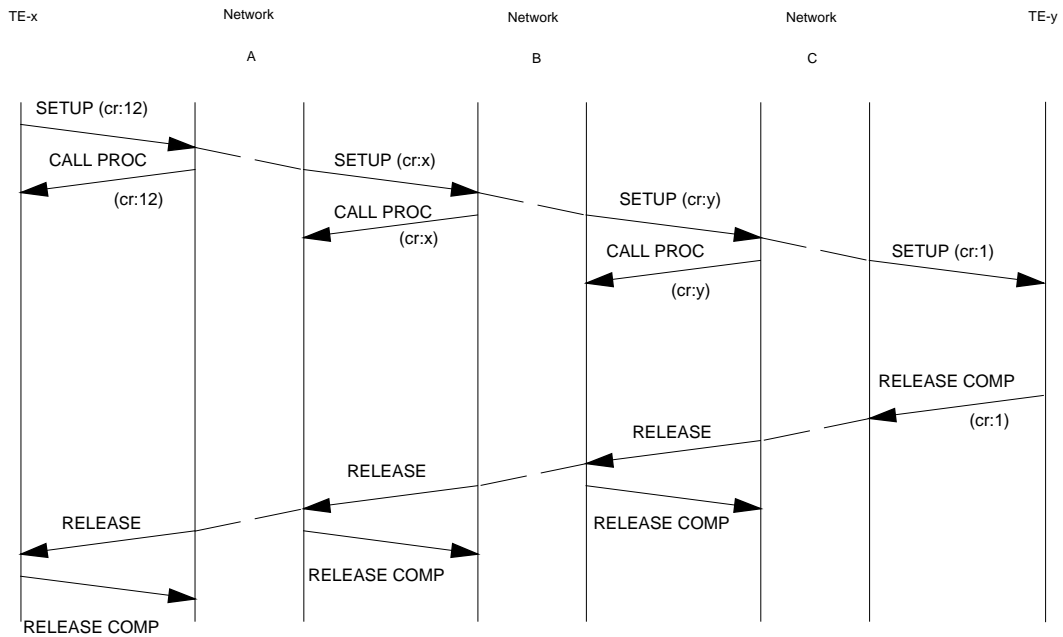

Figure 21-3 : Setup, unsuccessful call

21.3.3 Normal call clearing (from originator)

Figure 21-4 shows an example of call clearing from the active state, initiated by TE x.

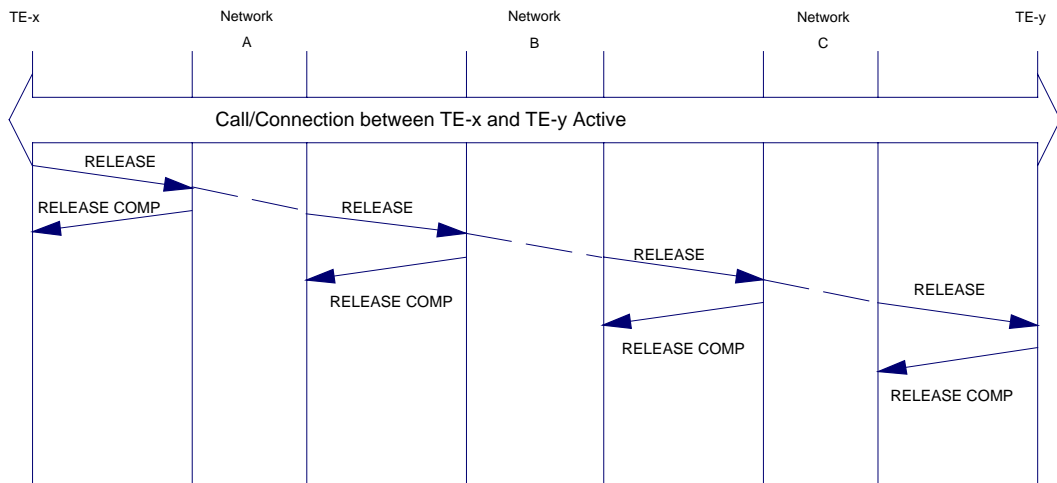

Figure 21-4 : Normal call clearing by originator

21.3.4 Call termination by a Private network

Figure 21-5 shows an example of a Private network terminating a call (for some reason, but not normal clearing) which is in the active state.

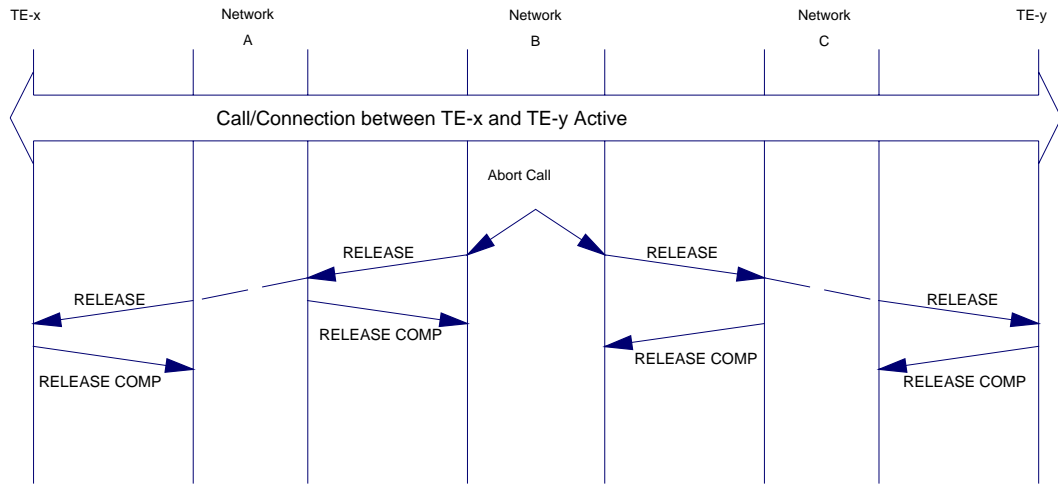

Figure 21-5 : Call termination by Network B

22. Appendix B: Derivation of Generic Connection Admission Control

As part of providing quality of service (QoS) and throughput guarantees, a switching system performs connection admission control (CAC) during connection setup phase to determine if a connection request can be accepted without violating existing connections' QoS and throughput requirements. To enable routing to produce paths that will likely be accepted, it is necessary for switching systems to advertise some information about their internal CAC states. Requiring switching systems to expose detailed and up-to-date CAC information, however, may result in unacceptably high routing traffic. Furthermore, CAC is not subject for standardization in PNNI, and so it is not practical for the switching systems to advertise their potentially different detailed CAC states. Generic connection admission control (GCAC) solves this problem by allowing switching systems to advertise CAC information that is generic (i.e., independent of the actual CAC used in the switching systems) and compact, but yet rich enough to support any CAC.

GCAC defines a set of parameters to be advertised and a common admission interpretation of these parameters. This common interpretation is in the form of a generic CAC algorithm to be performed during path selection to determine if a link or node can or cannot be included for consideration. The algorithm uses the advertised GCAC parameters (available from the topology database) and the characteristics of the connection being requested (available from signalling) to determine if a link/node will likely accept or reject the connection. A link/node is included if the GCAC algorithm determines that it will likely accept the connection, and excluded otherwise.

22.1 Generic CAC for CBR and VBR Service Categories

GCAC for CBR and VBR service categories uses the following parameters:

- ACR - Available Cell Rate, a measure of effective available bandwidth
- CRM - Cell Rate Margin, a measure of the difference between the allocated bandwidth and the aggregate sustained rate of existing connections
- VF - Variance Factor, a relative measure of the cell rate margin normalized by the variance of the aggregate rate

The assumption behind the generic CAC is that the ratio between CRM, which represents the safety margin the switching system is putting above the aggregate sustained cell rate, and the standard deviation of the aggregate rate (to be defined below) does not change significantly as one connection is added on the link. Using this assumption, each link advertises the current CRM and CRM-to-standard-deviation ratio. Any ingress switch doing path selection can then compute the new standard deviation of the aggregate rate (from the old value and the connection's traffic descriptors) and an estimate of the new CRM. From this, the increase in bandwidth required to carry the new connection can be computed and compared to ACR.

To expand on the discussion above, let AAC denote the actual allocated capacity, i.e., the amount of bandwidth that has been allocated to existing connections by the actual CAC used in the switching system. CRM is the difference between AAC and the aggregate sustained rate (ASR) of the existing connections. ASR can be either the sum of existing connections' declared sustainable cell rates (SCRs) or a smaller - possibly measured or estimated - value. Let MaxCR denote the maximum cell rate that is usable by either CBR or VBR connections (or both). The following diagram illustrates the relationship among MaxCR, AAC, ACR, ASR and CRM:

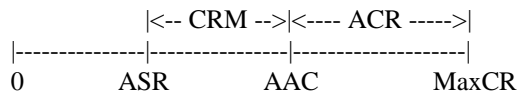

The assumption is that CRM is proportional to some measure of the burstiness of the traffic generated by the existing connections, this measure being the standard deviation of the aggregate traffic rate defined as the square root of the sum of $SCR_{excon}(PCR_{excon} - SCR_{excon})$ over all existing connections, where SCR_{excon} and PCR_{excon} are declared sustainable and peak cell rates, respectively. This assumption is based on the simple argument that AAC needs to be some multiple of the standard deviation above the mean aggregate traffic rate to guarantee some levels of cell loss ratio and cell queuing time. Depending on the actual CAC used, the CRM-to-standard-deviation ratio may vary as connections are established and taken down. It is reasonable to assume, however, that around some sufficiently large value of AAC, this ratio will not vary significantly. What this means is a link can advertise its current CRM-to-standard-deviation ratio (actually in the form of VF, which is the square of this number), and the GCAC algorithm can use this number to estimate how much bandwidth is required to carry an additional connection.

The GCAC algorithm is derived as follows: Consider a new connection with peak cell rate PCR and sustainable cell rate SCR, and a link with the following advertised GCAC parameters: ACR_{link} , CRM_{link} , and VF_{link} . Denote the variance (i.e., square of standard deviation) of the aggregate traffic rate by VAR_{link} (not advertised). Denote other unadvertised GCAC quantities by AAC_{link} and ASR_{link} . Then,

$$VAR_{link} = \text{SUM}_{\text{over existing connections excon}} SCR_{excon} * (PCR_{excon} - SCR_{excon}) \quad (1)$$

and

$$VF_{link} = \frac{CRM_{link}^{**2}}{VAR_{link}} \quad (2)$$

Using the above equation, VAR_{link} can be computed from the advertised VF_{link} and CRM_{link} as:

$$VAR_{link} = CRM_{link}^{**2} / VF_{link}.$$

Let Δ_{CR} be the additional capacity needed to carry the new connection. The GCAC algorithm basically computes Δ_{CR} from the advertised GCAC parameters and the new connections traffic descriptors, and compare it with ACR_{link} . If $\Delta_{CR} \leq ACR_{link}$ then the link is included for path selection consideration; otherwise, it is excluded, i.e.,

$$\begin{array}{l} \text{Include link} \\ ACR_{link} \geq \Delta_{CR} \\ < \\ \text{Exclude link} \end{array} \quad (3)$$

Let CRM_{new} denote the cell rate margin if the new connection were accepted. Denote other 'new' quantities by AAC_{new} , ASR_{new} , and VAR_{new} . Then,

$$\Delta_{CR} = CRM_{new} - CRM_{link} + SCR \quad (4)$$

since $CRM_{new} = AAC_{new} - ASR_{new}$, $CRM_{link} = AAC_{link} - ASR_{link}$, and $ASR_{new} - ASR_{link} = SCR$. Substituting (4) into (3), rearranging terms, and squaring both sides yield:

$$\begin{array}{l} \text{Include link} \\ [ACR_{link} + CRM_{link} - SCR]^{**2} \geq CRM_{new}^{**2} \\ < \\ \text{Exclude link} \end{array} \quad (5)$$

Using the GCAC assumption made earlier, CRM_{new}^{**2} can be computed as:

$$CRM_{new}^{**2} = VF_{link} * VAR_{new}, \quad (6)$$

where

$$VAR_{new} = VAR_{link} + SCR * (PCR - SCR). \quad (7)$$

Substituting (2), (6) and (7) into (5) yields:

$$\begin{array}{l}
 \text{Include link} \\
 [\text{ACR_link} + \text{CRM_link} - \text{SCR}]^{**2} \geq \text{CRM_link}^{**2} + \text{VF_link} * \text{SCR}(\text{PCR} - \text{SCR}), \\
 < \\
 \text{Exclude link}
 \end{array} \tag{8}$$

and moving CRM_link^{**2} to the left-hand side and rearranging terms yield

$$\begin{array}{l}
 \text{Include link} \\
 [\text{ACR_link} - \text{SCR}] * [\text{ACR_link} - \text{SCR} + 2 * \text{CRM_link}] \geq \text{VF_link} * \text{SCR}(\text{PCR} - \text{SCR}). \\
 < \\
 \text{Exclude link}
 \end{array} \tag{9}$$

In general Δ_{CR} is between SCR and PCR. So the above test is not necessary for the cases $\text{ACR_link} \geq \text{PCR}$ and $\text{ACR_link} < \text{SCR}$. In the former case, the link is included; in the latter case, the link is excluded.

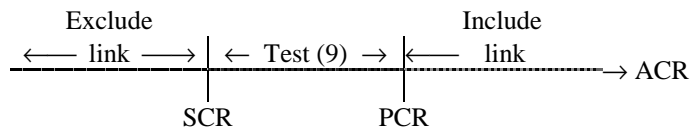

22.2 Generic CAC for UBR and ABR Service Categories

In UNI 3.0 Sec. 3.6.2.4, it is stated that connection admission control shall not reject a UBR call based on bandwidth availability but it may reject based on other reasons such as number of UBR calls exceeding a chosen threshold. GCAC defines only one parameter for UBR service category - maximum cell rate (MaxCR) - to advertise how much capacity is usable for UBR connections. The purpose of advertising this parameter is twofold: MaxCR can be used for path optimization, and $\text{MaxCR} = 0$ is used to indicate that a link is not accepting any (additional) UBR connections.

23. Appendix C: Guidelines for Topology Aggregation

To preserve the flexibility of the complex node representation for PNNI Routing, no requirements are specified for when and how the nodal state parameters constituting the complex node representation should be generated. Nevertheless, the following guidelines are provided for discretionary use only.

23.1 Diameter and Radius

For each nodal state parameter, the “diameter” of a logical node is defined as an aggregation of all parameter values in a full-mesh representation of the logical node. Each “diameter” must be converted to a “radius” for the default node representation in the PNNI complex node representation. For a nodal metric, the “radius” is simply half the “diameter”. For a nodal attribute, the “radius” is the same as the “diameter”.

23.2 Presumed Nodal State Parameters

PNNI routing does not specify how presumed nodal state parameters are determined for the default node representation. A conservative approach determines the entire set of parameters based on a single path selection criterion, whereas an aggressive approach determines each of them based on a possibly different path selection criterion. The degree of aggressiveness is left to the discretion of the advertisers.

23.3 Significant Exceptions

Exceptions are useful if they provide “significantly different” topology information than that revealed by the default node representation in the PNNI complex node representation. For example, one could designate a connectivity between a port and the nucleus on a default node representation as an exception to expose an outlier, which is a node whose exclusion from the peer group it belongs to would significantly improve the accuracy and simplicity of the aggregation of the remainder of the peer group topology.

23.4 Useless Exceptions

It is useful to identify conditions under which a link is not to be designated as an exception. For example, we may consider the following condition. A link is said to be dominated by a path if at least one parameter value of the link is less desirable than the corresponding parameter value of the path, and all other parameter values are pair-wise equal. Since PNNI Routing selects internal paths through a logical group node from the best concatenation of links in the complex node representation in a normal manner, it is not useful to designate a logical link to be an exception if it would be dominated by at least one alternate path in the advertised topology.

23.5 Number of Exceptions

While PNNI Routing does not specify a hard limit on the number of exceptions, it is recommended that the number of exceptions used to configure a complex node representation of a logical group node be normally kept smaller than 3 times the number of ports in the logical group node. For logical group nodes with a small number of ports, it is acceptable for as many as all the port-to-port connectivities to be designated as exceptions.

24. Appendix D: Multi-Peer Group Systems

There are a number of cases in which it is useful for a single physical system to implement the functions of multiple PNNI nodes. This allows a single physical system to be included in multiple peer groups. This does not require any change in the PNNI protocol, and therefore cannot in fact be prohibited. This capability also significantly expands upon the flexibility and usefulness of the PNNI Routing Protocol.

This section describes some of these cases, and is intended as explanatory material. This section does not require nor propose any actual change in the PNNI protocol.

The following situations have been identified in which one physical system may want to directly participate in the operation of multiple peer groups:

1. Peer group leader (in a child and a parent peer group)
2. Border systems (in two bordering peer groups)
3. Core systems in branchy networks
4. Backbone and local area topology

24.1 Technical Details

24.1.1 Peer Group Leader

The most obvious case of a single real physical system operating in multiple peer groups is the peer group leader (PGL). The PGL operates as a normal member of a peer group, and also, as the elected leader of the peer group, operates as a normal member of the parent peer group.

The PGL is required to feed information between the parent and child peer group. In order to allow nodes within the child peer group to route to destinations outside of the peer group, the PGL feeds higher level PTSEs into the peer group. In order to allow nodes outside of the peer group to route to destinations within the peer group, the PGL announces (in its PTSEs transmitted into the parent peer group) reachability to one or more address prefixes which summarize the destinations reachable within the child peer group.

24.1.2 Border Systems

In some cases, a single node may sit on the boundary between two neighboring peer groups. This situation is illustrated in Figure 24-1. Here a single real physical system "X" sits on the boundaries between peer groups A and B.

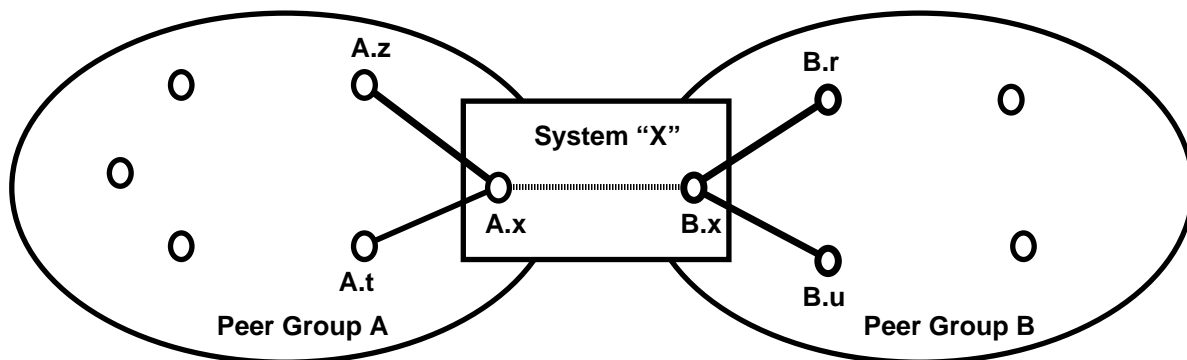

Figure 24-1: Border Node between Peer Groups A and B

The situation illustrated in Figure 24-1 may occur in the normal operation of PNNI within a single larger ATM Private Network which is also running PNNI. In this case, the border system X operates just as if it were two separate systems A.x and B.x, using the normal PNNI protocol mechanisms. The information exchange corresponding to the dotted line internal to system X corresponds to the normal exchange of PNNI information between neighboring PNNI systems in different peer groups. System X may choose to run PNNI internally in this case, or may use a proprietary implementation as long as the external behavior conforms to normal PNNI behavior for border nodes.

This situation may occur at administrative boundaries between different organizations. In this case, separate instances of PNNI routing may be used on each side of the administrative boundaries. It may be necessary to carefully control the exchange of information between these two instances. This is similar to the exchange of routing information between OSPF and BGP at domain boundaries in an IP network. This allows PNNI to be used both as an intra-domain "interior" routing protocol in a private organization, and as an inter-domain routing protocol between organizations.

In this latter case, the exchange of routing information between different instances of PNNI may be referred to as "inter-domain PNNI". A "Router Management" function allows the inter-domain routing exchange to follow specific administrative requirements.

The details of the router management function is for further study (this is a common function in the IP Internet, and we may use current Internet practice as a start in definition of a router management function for PNNI). Typically, the routing manager allows configuration of which summary addresses to advertise as reachable, and which summary addresses to accept if the other system advertises these as reachable.

In many inter-domain cases, the system may choose to announce reachability to specific address prefixes, plus metrics describing the cost of reaching addresses which match that prefix, without being able to (or choosing to) announce sufficient detail to allow creation of associated DTLs. This implies that in some cases the DTL may terminate at a boundary system. In this case, if PNNI routing is used in both domains, the system may create a new DTL to continue the call into the other domain.

In many cases, organizations want to maintain control over their own networks, including management of border nodes. Thus the situation illustrated in Figure 24-1, in which one border node is shared between two routing domains, may be unacceptable.

A further extension of the border case is illustrated in Figure 24-2. Here the two domains A and B do not share a common border system. Rather, domain A has control over border system X, and domain B has control over border system Y. Systems X and Y communicate via a simple instance of PNNI Routing, which comprises one peer group and two nodes. This peer group may be called an "interdomain peer group", in that its sole purpose is to interconnect the two domains A and B.

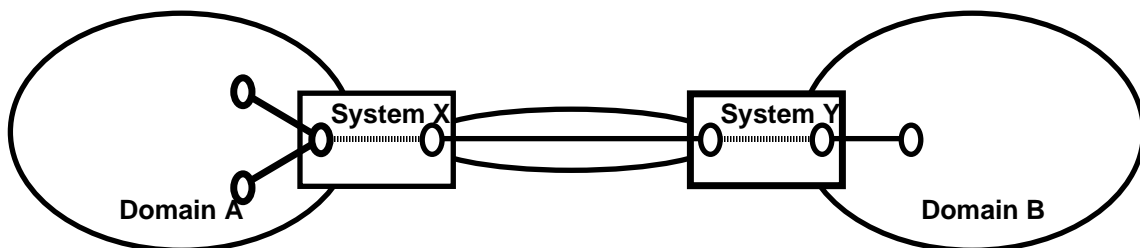

Figure 24-2: Two Domains with Individual Border Nodes

The operation of the border nodes in Figure 24-2 is very similar to the operation of the single border node in Figure 24-1.

In this case, note that it is not necessary for both (or either) domains to run PNNI routing internally. For example, Domain A may represent a private ATM network which is running PNNI internally. System X is therefore configured to control the exchange of reachability information between the private PNNI domain internal to Domain A, and the inter-domain instance of PNNI. On the other hand, Domain B may be either another private domain, or a public domain, which is running some other routing protocol internally. Thus, PNNI provides one possible way to exchange information between domains, and can be used even when one or both domains is not running PNNI internally.

24.1.3 Core System in a Very Branchy Network.

Some networks are characterized by a relatively moderate number of high performance "core systems", each of which has links to a large number of smaller (generally lower performance) non-transit stub systems. The core systems may be attached in a high-performance backbone. The stubs receive connectivity to other sites (including other stubs) via the backbone.

Where there are a large number of non-transit stubs attached to a single common core system, any one stub does not need to know the detail regarding the other stubs. This implies that the large number of stubs attached to a single core system should not be considered part of a single common peer group. This implies that the core system needs to operate as a member of multiple peer groups.

24.1.4 Backbone and Local Area Topology

Figure 24-3 illustrates another common topology, in which a network has a central backbone, plus multiple local areas. This is somewhat similar to the branch topology described above, except that in this case the core systems are each attached to only one (or a small number of) local areas. In Figure 24-3, there are six high performance backbone nodes A through F, connected via high bandwidth links (shown as heavy lines in our example). There are also three local areas X, Y, and Z, each of which contains a number of lower speed switches and lower bandwidth links (only the internal structure of area X is illustrated in Figure 24-3).

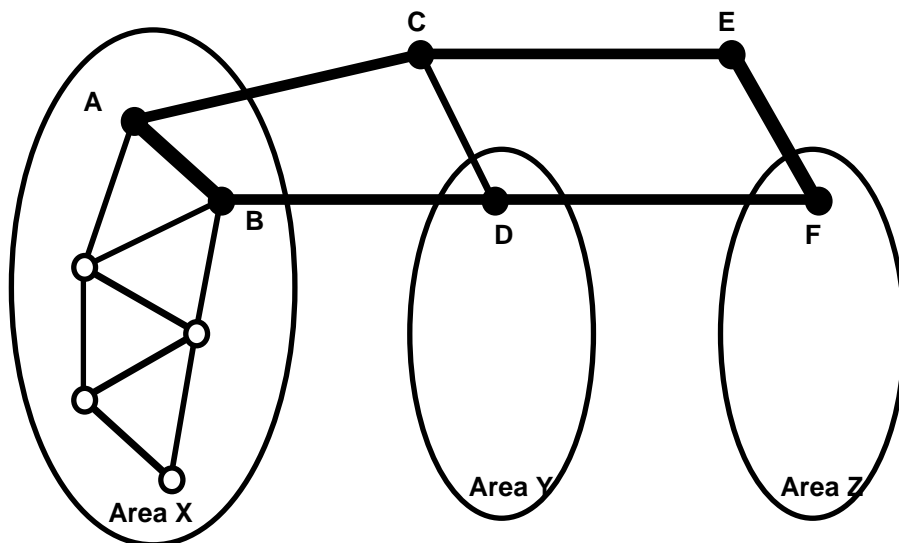

Figure 24-3: Backbone and Local Area Topology

In topologies such as this, a sensible way to manage the network is for each local area (areas X, Y, and Z in our example) to be configured as low level peer groups, and the backbone (comprising nodes A through F, plus the high bandwidth links) to be configured as the higher level parent peer group for each of the lower level peer groups. This implies, for example, that systems A and B are part of both the peer group consisting of Area X, and also the backbone peer group.

Proposed Disposition Of This Section

This section has pointed out a number of cases in which a single real physical system will need to participate in multiple peer groups, and therefore implement the functions of multiple logical nodes (one logical node in each peer group). It is suggested that this is a relatively normal case, and that the flexibility and usability of PNNI routing will be enhanced by allowing for these cases. It is suggested that the precise interactions between the multiple logical nodes represented within a single physical system may depend upon the topology of the network. Thus, the PNNI Subworking group should identify specific topologies of interest, and should specify the proper operation in each case.

~~The text contained in Section 19.1 may be thought of as an outline for explanatory material. This is intended to point out ways that PNNI routing may be used. This material does not require any change in the PNNI protocol, however, this material may serve as useful guidance to implementers and users of PNNI Routing.³~~

25. Appendix E: Allocating Resources in Transit Peer Groups

When a switch calculates a DTL (either in advance or in response to a call request) the calculations make assumptions about the amount of resources that peer groups along the selected path will consume. For example, the calculator assumes that the peer group will be prepared to use up only as much delay as it has advertised. For any cumulative metric, the total of the values from each traversed peer group are then compared with what the caller requested.

If now a transit peer group chooses a path with a longer delay than the advertised value, it is quite possible for the call to become blocked by exceeding the delay request somewhere further along the path.

This is a particular problem if the transit peer group could have chosen a lower delay path, but chose not to. The crankback message will come past the transit peer group, and that group will never be told that there was a delay problem, and that it should pick a lower delay path.

An attractive first cut solution was to communicate the optimization objective that was used originally. However, it can easily be seen that the problem is related to the values used, and not the optimization objective. For example, the initial optimization may have been on the basis of administrative weight. The calculated path may just barely meet the needed delay. Depending on how the transit peer group derived its announced delay metric, it may well be that an administrative-weight optimized path will not meet the needs. Further, it can be seen that communicating the objective function would constrain systems from implementing new and different optimization functions, when such local flexibility is intended as a feature of this protocol.

If that will not solve the problem, what will? The following are heuristics that will increase the probability of a transit peer group picking a useful internal path. These are not mandatory behaviors. Several are included because they address several cases and have differing complexity. In the following, what is being described is the behavior of a switch at a peer group border upon receiving a call from outside the peer group with a DTL which transits the peer group. The concern is what delay budget to allow when calculating a path across the peer group. The assumption in the following is that the call did have a delay bound, and therefore the amount of delay consumed in this transit peer group is significant.

- 1) Use the advertised value. If the peer group was advertised with a single nodal metric for delay (for the relevant category of service), then use the advertised value as the target. If a path can not be calculated which meets the other call objectives and meets the advertised delay, then calculate a path with the best possible delay meeting the call.
- 2) Use the call and the path. The call has an indication of how much of the requested delay has already been consumed. It also has a DTL stack. Examining the DTL stack, the switch can attempt to calculate how much delay would be used by the remainder of the call. Adding this to the amount consumed, and subtracting from the original request gives a good target for the value which this peer group should attempt to meet. This algorithm refers to attempting to calculate the consumed delay due to complex nodal metrics. If there are no complex nodal metrics along the path, then a value equivalent to that used by the originating switch will be generated (equivalent up to any changes in advertised information). However, if there are nodes with complex metrics, the switch will have to pick a path, which appears to meet the call, across the peer group. This parallels what the originating switch did, but could pick a different crossing path. Thus, even here there is the potential for mismatching behavior and unfortunate crankback.

Once the delay target has been selected, the same use can be made of it as in (1) above.

26. Appendix F: PNNI Packet Sizes

This appendix provides formulae for conservative estimates of the octet counts in the PNNI packets.

26.1 PNNI Hello Packet (PHP)

PHPs are exchanged between neighbor nodes over each physical link and VPC in order to discover and verify the identity of neighbor nodes and to determine the status of the links to those nodes. In addition, Hellos are also exchanged between neighbor LGNs over each SVCC-based RCC to identify port IDs and determine the status of horizontal links.

Let L denote the number of known higher levels with respect to a neighbor of a given node.

Let C denote the number of service categories. Each RAIG consists of 32 octets of required information and 12 octets of optional GCAC related information. Thus, the maximum number of octets in an RAIG is 44. The bit-mask encoding in each RAIG allows for one IG to be used to specify resource availability information for several service categories which share common resource availability information. Separate RAIGs must be used for service categories which do not share common resource availability information. In this respect, a conservative estimate (upper bound) for the total number of octets in RAIGs for all service categories is $44C$.

The contents of a PHP are listed in Table 26-1.

Table 26-1: Contents of PNNI Hello Packet

Information Entities	Number of Octets
Hello Common Part	100
Aggregation Token IG	8
Nodal Hierarchy List IG	$12 + 56L$
Uplink Information Attribute IG	$8 + 44C$
LGN Horizontal Links Extension IG	X

Let H denote the number of horizontal links. In Table 26-1, $X = 0$ at the lowest hierarchical level where there is no LGN, and $X = 8 + 12H$ at higher levels.

Total number of octets in a PHP transmitted within a peer group = $100 + X$.

Total number of octets in a PHP transmitted across a peer group boundary = $128 + 56L + 44C$.

26.2 PNNI Topology State Packet (PTSP)

PTSPs are used to distribute topology information throughout a peer group. A PTSP originated by a node captures the topology information about the node, including its complex node representation, as well as all horizontal links and uplinks attached to the node. In PNNI Routing, a complex node representation is a collection of nodal state parameters that provide detailed state information associated with a logical group node.

Let P denote the number of ports in the complex node representation associated with the node that originates the PTSP.

Let D be denote the number of octets for next higher level binding information. $D = 84$ if there is a higher level, and $D = 0$ otherwise.

Let N denote the number of octets in a Network Identification (one octet per IA5 character).

Let W denote the number of octets in an Uplink Information Attribute IG, where $W \leq 8 + 44C$ octets.

The contents of a PTSP are listed in Table 26-2.

Table 26-2: Contents of PNNI Topology State Packet

Information Entities	Number of Octets
PTSP Header	44
PTSE Header	20
Nodal State Parameter IG	16 + 44C
Nodal IG	48 + D
Internal Reachable ATM Address (IRA) Information	A
Exterior Reachable ATM Address (ERA) Information	B
IRA IG Overhead	16 + 2*44C
ERA IG Overhead	16 + 2*44C
Transit Network ID	7 + N
Horizontal Links IG	40 + 44C
Uplinks IG	72 + 44C + W

Note that IRA information and ERA information each includes the reachable address prefix as well as 1 octet indicating prefix length.

In Table 26-2, padding must be included, if necessary, in the estimates for the IRA information, the ERA information, and the Transit Network ID.

$$\text{Total number of octets in a PTSP} = 44 + 20 * (\text{Number of PTSEs in the PTSP}) \\ + (\text{Total payload of PTSEs in the PTSP})$$

$$\text{Total payload of PTSEs in the PTSP} = (16 + 44C) * f(P) \\ + 48 + D \\ + (16 + 2*44C) * (\text{Number of IRA Igs}) \\ + A * (\text{Total Number of IRA Prefixes}) \\ + (23 + 2*44C + N) * (\text{Number of ERA Igs}) \\ + B * (\text{Total Number of ERA Prefixes}) \\ + (40 + 44C) * (\text{Number of Horizontal Links}) \\ + (72 + 44C + W) * (\text{Number of Uplinks})$$

where $f(P)$ is the number of nodal state parameters in the complex node representation.

The above estimate is obtained with the following assumptions:

- All IRA prefixes with padding have the same length.
- All ERA prefixes with padding have the same length.
- All transit network identifications with padding have the same length.

With the above assumptions, one can determine an upper bound on the total payload of PTSEs in a PTSP by letting the constants respectively take on conservative estimates.

26.3 PTSE Acknowledgement Packet (PTSE_AP)

PTSE_APs are used to acknowledge the receipt of PTSEs from a neighbor node. Each PTSE_AP consists of multiple Nodal PTSE Acknowledgement IGs, and each of these IGs is used to acknowledge the receipt of multiple PTSEs with the same originating node and transmitted by the same neighbor node.

The contents of a PTSE_AP are listed in Table 26-3.

Table 26-3: Contents of PTSE Acknowledgement Packet

Information Entities	Number of Octets
PTSE_AP Header	8
Nodal PTSE Acknowledgement IG	28
PTSE Acknowledge Overhead	12

$$\begin{aligned}
 \text{Total number of octets in a PTSE_AP sent by a given node} &= 8 \\
 &+ 28 * (\text{Total Number of PTSE Ack Sets in the PTSE_AP}) \\
 &+ 12 * (\text{Total Number of PTSE Acks in the PTSE_AP}) \\
 &\leq 8 + 40 * (\text{Total Number of PTSE Acks in the PTSE_AP})
 \end{aligned}$$

The upper bound is obtained by assuming the worst case where each PTSE Ack Set contains only one PTSE Ack.

26.4 Database Summary Packet (DBSP)

DBSPs are used during the initial database exchange process and contains the header information of all PTSEs in a node's topology database. Each DBSP consists of multiple Nodal PTSE Summaries IGs, and each of these IGs contains the PTSE header information of multiple PTSEs with the same originating node and transmitted by the same neighbor node.

The contents of a DBSP are listed in Table 26-4.

Table 26-4: Contents of Database Summary Packet

Information Entities	Number of Octets
DBSP Header	16
Nodal PTSE Summary IG	44
PTSE header Overhead	16

$$\begin{aligned}
 \text{Total number of octets in a DBSP sent by a given node} &= 16 + 44 * (\text{Total Number of PTSE Summary Sets in the DBSP}) \\
 &+ 16 * (\text{Total Number of PTSE Headers in the DBSP}) \\
 &\leq 16 + 60 * (\text{Total Number of PTSE Headers in the DBSP})
 \end{aligned}$$

The upper bound is obtained by assuming the worst case where each DB Summary Set contains only one PTSE Header.

26.5 PTSE Request Packet (PTSE_RP)

PTSE_RPs are used during database synchronization to request from a neighboring peer those PTSEs that have been newly discovered or that have been found to be obsolete. Each DBSP consists of multiple Requested PTSEs IGs, and each of these IGs contains multiple request PTSEs with the same originating node and transmitted by the same neighbor node.

The contents of a PTSE_RP are listed in Table 26-5.

Table 26-5: Contents of PTSE Request Packet

Information Entities	Number of Octets
PTSE_RP Header	8
Requested PTSE IG	28
Requested PTSE Overhead	4

Total number of octets in a PTSE_RP sent by a given node
 $= 8 + 28 * (\text{Total Number of PTSE Request Sets in the PTSE_RP})$
 $+ 4 * (\text{Total Number of PTSE Requests in the PTSE_RP})$
 $\leq 8 + 32 * (\text{Total Number of PTSE Requests in the PTSE_RP})$

The upper bound is obtained by assuming the worst case where each PTSE Request Set contains only one PTSE Request.

27. Appendix G. Flooding Parameter Selection Guidelines

The objective of flooding is the dissemination of information in the fastest possible way reliably in the network. The flooding speed will depend on many factors like link speeds, node processing speed, network topology etc. It seems very likely that the flooding bottleneck will be the switching system processing speed. One way to reduce the processing load on the switches is to acknowledge a group of PTSE's in a single packet. This is done by appropriately selecting the PeerDelayedAckInterval. The PeerDelayedAckInterval is the time interval between consecutive checks of the PeerDelayedAcks list to verify if we have any outstanding unacknowledged PTSE's. If there are any unacknowledged PTSE's their headers are bundled in an acknowledgment packet and sent out the link.

27.1 Basic Parameter Relations

In order for the ATM network to function without excessive retransmissions PTSERetransmissionInterval and PeerDelayedAckInterval need to satisfy the following basic inequality:

$$\text{PTSERetransmissionInterval} > \text{PeerDelayedAckInterval} + \text{Rtdelay}$$

where Rtdelay is the round trip delay suffered by the PTSP. This delay might be negligible for links at the lowest level of the hierarchy, and could be important as we move up the hierarchy.

27.2 Higher Hierarchical Levels

When we move up the hierarchy, parameters like PTSERetransmissionInterval will have to be configured with higher values due to the fact that links are represented by virtual ~~circuits-connections~~³ and nodes by Peer Groups. Logically this is equivalent to having a network with links and nodes that are slower (more delay while traversing the virtual ~~circuit-connection~~³ forming the logical link, and nodes that are Logical Group nodes). More the cell loss ratio on such links and nodes might be increased which makes it more likely for retransmissions to occur while flooding. The PTSERetransmissionInterval for a selected hierarchical level has to take these facts into consideration for the ATM network to behave efficiently.

27.3 Varying the PeerDelayedAckInterval

The selection of the PeerDelayedAckInterval will affect the average number of PTSE acknowledgments grouped in a single packet. The longer the PeerDelayedAckInterval the more likely we will gather a larger number of acknowledgments and reduce the number of packets flooded in the network. We can increase the PeerDelayedAckInterval as long as we satisfy the inequality stated above. In the case of intensive flooding we might reach a scenario where we have gathered many elements in the Delayed Acknowledgment list and we would like to acknowledge them. In such a case we can achieve the grouping effect with a small PeerDelayedAckInterval and could risk running out of buffers if we continued to delay the acks. As we can see the selection of the PeerDelayedAckInterval might be influenced by the switch performance and memory. More it could be related to the frequency at which new PTSPs are generated in the network (intensive flooding due to frequent significant changes in the nodal and link metrics).

27.4 Default PeerDelayedAckInterval Value

Viewing the reasoning presented above we need to establish a default value for the PeerDelayedAckInterval. We can make a rather safe assumption that the Rtdelay for a worst case scenario at the highest level of the hierarchy would not be greater than 2 seconds. In such a case a default PTSERetransmissionInterval could be in the order of 5-10 seconds. If we assume PTSERetransmissionInterval 5 seconds as default, then the PeerDelayedAckInterval should not be greater than 1 or 2 seconds to assure some security margin in the inequality stated above.

Thus the default values of 5 second for PTSERetransmissionInterval and 1 second for PeerDelayedAckInterval would be independent of the hierarchy level (worse case scenario). The user might select to modify these values to tune its network flooding parameters for specific hierarchical levels viewing the guidelines presented.

28. Appendix H: A Sample Algorithm for Route Generation

As part of the PNNI specification, it is desirable to specify sample algorithms which generate useable routes in a fashion compliant with the formal specification.

There are two general categories of route generation algorithms. One category is an algorithm used to generate route(s) to all possible destination. The sample given here does this for a single service category and a single optimization criteria. A straightforward process might be to run this in the background for each service category and for each single optimization criteria within that category. This would produce a set of precalculated routes to use for an incoming call. In addition, one needs an algorithm to calculate a route for a given call. This is needed when the precalculated routes do not meet the callers parameters.

It should be noted that in these algorithms the structure of the received information is assumed (as it will) to reflect the hierarchical structure, and therefore the algorithm does not need proceed iteratively through hierarchical levels. However, when the path is convert into DTLs, level analysis is needed.

In order to describe this algorithm, we need an abstract description of the database. We will use arrays for most of the description, with arrays being indexed from 1.

Nodecount = The number of nodes in the database. For this purpose, a node with complex metrics counts as one node.

AllNodeCount = The count of all nodes, with ports which are identified in complex metrics counting as well.

Linkcount = count of links, include links described in complex metrics. **Classcount**= The number of supported service categories

AllNodes[AllNodeCount] = The array of nodal structures. This includes the reachability information and, for nodes without complex metrics, (or default nodes in the complex case) the nodal metrics. Subfields are:

LinkCount: The number of links out of this node.

Classinfo[classcount]: The metric info for each class. The metric info includes whether the class is supported.

Reachability: The list of prefixes reachable from this node.

IsComplex: True for everything except the default-entry of a complex node

CenterNode: If this is a node created by a complex metric, this points to the default node for reachability purposes.

ParentNode: The index of the Parent, or -1 if there is none.

Links[Linkcount] = The attributes of the link. These include

SrcNode, DestNode: The indices of the starting and ending node of the link.

IsUplink: True if this is an uplink from a node.

PairedLink: The link in the obverse direction **Classinfo[Classcount]**: metrics for the service categories

IsInternal: True if this link is generated by a complex node metric.

For an Uplink, there will be a backlink. However, no node will point to the backlink as an outward-going link. It is only used as the reverse of an uplink. If one wishes to calculate from destinations towards the source, then one would put the DownLinks as the actual link, and the uplinks would only be reachable as the obverse of the DownLinks. It is necessary to avoid having both, or looping paths can result.

MaxOutLink = The maximum number of outward links from a node. Note that in a practical implementation this is unlimited and a different structure should be used.

OutLinks[AllNodeCount, MaxLinkCount] = The index into "Links" of the links out of a given node.

This = This index of the starting node in AllNodes

We will also use a data type of "path". This represents node traversal sequence. It also has cumulative values of the metrics in use.

Description of Generate_All_Routes_Q(C)

C is the service category, and Q is the metric index to optimize. This must be an additive metric, so that it can be the target of a Dijkstra. To generate all possible routes for a given service category C, with an optimization criterion Q, we will need some auxiliary information. For purposes of this sample, the optimization is on a single forward-direction metric. It could as easily be a backwards-direction metric. This is independent of whether paths are calculated from the source or from the destination. In fact, any mathematical function of the forward and reverse direction metrics and attributes could be used, so long as the result of the function is a single value such that when elements are added to a path, the single positive non-zero value for that element is added to the value for the path. (So, one could use a scaled average of the forward and backwards administrative weight and delay if one so chose.) In most cases, simply optimizing once for the forward administrative weight, and once for the forward delay, will give reasonable pre-computed paths.

BestCosts[AllNodeCount]: This is the best cost to each destination node. While we are actually only interested in basic nodes, this array must have size equal to AllNodeCount for accumulation purposes. This is initialized to -1 to indicate that no paths have been found.

To initialize BestCosts, set the cost for "This" node and all its containing nodes to 0. This represents the fact that we are already here and do not need to find a way here.

BestPaths[AllNodeCount]: This is an array of paths select to the destinations. It is initialized to Empty. If multiple paths are to be recorded, this will be a double array, [AllNodeCount, pathcount]

Tent: A list of paths sorted by the optimization criteria. To initialize this, create the set of paths consisting of "This" Node and each link out of "This" Node.

Then, the algorithm will proceed to run a Dijkstra on the database. The Dijkstra will use whatever optimization criteria (an accumulating metric) has been selected. If desired, paths within a cost "epsilon" of best may also be retained. Epsilon must be small enough that looping is impossible. (For administrative cost, this turns out to be 2 since we internally suppress immediate backtracks.)

PseudoCode:

A number of utility routines are used in the algorithm:

Admit_Link_All(Link, C, Q):

This routine tests whether a link can be used for a given service category and optimization criteria. It checks that the category is supported, and that a non-zero value exists for the metric.

Create_Path(...):

This routine creates a path data structure, with the elements given.

Make_Path(Node, Link, C, Q)

```

    path p;
    p = Create_Path(Node, Link, Links[Link].DestNode);
    p.cost    =    AllNodes[Node].Classinfo[C].Metric[Q]    +    Links[Link].Classinfo[C].Metric[Q]    +
                  AllNodes[Links[Link].DestNode].Classinfo[C].Metric[Q];
    return(p);

```

Append_Path(Path, Link, C, Q)

```

    path p;

```

```

integer i;

p = Create_Path(Path, Link, Links[Link].DestNode);
p.cost = Path.cost +
        Links[Link].Classinfo[C].Metric[Q] +
        AllNodes[Links[Link].DestNode].Classinfo[C].Metric[Q];
/* accumulate all metrics */
for (i = 1 to metric_count)
    path.metric[i] = Path.metric[i] + Links[Link].Classinfo[C].Metric[i] +
        AllNodes[Links[Link].DestNode].Classinfo[C].Metric[i];
/* Now combine attributes using the appropriate min, max, mask,
   or other rule depending on the attribute */
for (i = 1 to attribute_count)
    path.attribute[i] = combine_attribute(path.attribute[i], Links[Link].Classinfo[C].attribute[i],
        AllNodes[Links[Link].DestNode].Classinfo[C].attribute[i]);
return

```

Add_to_Tent(Path, C, Q, Tiebreakers):

Insert the path into the tent, sorted by C/Q and the Tiebreakers so that one can remove entries from the tent in sorted order.

Remove_Smallest(Tent):

returns the lowest cost path in tent, and removes it from the tent.

Last_Node(Path):

returns the index of the last node in the path.

Last_Link(Path):

returns the index of the last link of the path.

Tent_Empty(Tent):

tests whether the tent is empty.

Record_Path(Path, C, Q, Tiebreakers):

Check whether the path is good enough to record. If so, record it, updating Best_Costs and Best_Paths.

If multiple paths are being allowed, with a metric tolerance, this routine enforces that tolerance. It uses Tiebreakers to decide between otherwise equally good paths. In order to prevent paths from re-entering the same node through different complex metrics, a special check is done in Record_Path.

When a path with given "cost" to a given "node" is being considered, and "node" is a complex node, and the last link is not an internal link (e.g. this is an arrival), then the path is admitted against the list for the real node, as well as the individual complex node. This results in the node as a whole being used for external paths, while still generating internal paths.

This behavior, while it prevents re-entry, also restricts finding certain classes of alternate paths. Specifically, it can not find paths which have a more expensive path to a certain transit node with a complex nodal metric, and then a cheaper transit cost leading to a cheaper total cost. Using the approach above gives robust path generation. All switches are required to follow the DTLs exactly, whether they have been generated with such loop avoiding behavior or not. As such, implementers may consider removing the special check described above, or relaxing it.

Generate_all_routes(C, Q, Tiebreakers)

/* For Service Category C, with optimization criteria Q, generate optimal and

```

nearly optimal paths. Tiebreakers helps order otherwise equal paths/links */

integer i, j, k;
path p, q;

for (i = 1 to AllNodeCount)
    BestCosts[i] = -1;
    for (j = 1 to Pathcount)
        BestPaths[i, j] = NIL;

Tent = Empty;

i = This;
while (i > 0)
    BestCosts[i] = 0;
    i = AllNodes[i].ParentNode;

for (i = 1 to AllNodes[This].LinkCount)
    /* Make sure that the links can be used for this service category
    and optimization parameter */
    if (Admit_Link_All(OutLinks[This,i], C, Q))
        /* The Path carries the cumulative cost for the prime condition */
        p = Make_Path(This, OutLinks[This, i], C, Q);
        Add_to_Tent(p, C, Q, Tiebreakers);

while (not Tent_Empty(Tent))
    p = Remove_Smallest(Tent);
    i = Last_Node(p);
    k = Last_Link(p);

    /* Check if the cost is good enough to be useable */
    if (Record_Path(p, i, C, Q, Tiebreakers))

        /* Now examine the outlinks, and put them into the tent */
        for (j = 1 to AllNodes[i].LinkCount)
            /* check if the link is useable */
            if (Links[k].PairedLink != j /* do not backtrack directly */ && Admit_Link_All(OutLinks[i, j],
                C, Q))
                q = Append_Path(p, OutLinks[i, j], C, Q);
                Add_to_Tent(q);

```

When this is complete, there will exist a set of paths to each destination node for the given service category and optimization criteria. These can then be used to create candidate DTLs for locally originated calls to the destinations reachable at the given node. The behavior in Record_Path of associating node entries with the node as a whole, combined with the fact that reachability is associated with the node as a whole, means that nodal reachability is associated with any entry, and therefore is not affected by internal partitions, spanning tree representations, or other issues. If we associated reachabilities with entry ports at some later time, then again the association will work.

It should be noted that the data structure for recording the selected pre-calculated paths should obey the rule of "longest match" whereby a longer match is better than a shorter one, no matter what the metric.

There is one caveat to be borne in mind. The paths generated thus far are NOT directly suitable for use in generating paths to obey a received DTL. If we are in node B.1 and we receive a DTL which specified (A, B, C) then we must generate a path across B, to C. That path may not traverse an additional top level peer group D. In contrast, when we originate a call, it is perfectly ok to go through D to C, even when C is a neighbor.

To handle this, one additional data structure should be pregenerated.

Go through the list of links, and find all Uplinks. create two tables, DownCount[AllNodeCount] and DownLinks[AllNodeCount, MaxOccurrences]; DownCount tells how many uplinks there are to a given node. DownLinks contains the index of each uplink. When given a DTL to obey, look up the destination. If DownCount is 0, give up. Otherwise, the set of candidate paths are the paths to the sources of the DownLinks[DTL_Entry, ...]. These are all within the peer group, and therefore are valid destinations. By the re-entry suppression of the generation algorithm, the paths are all valid.

On demand calculation

When the set of precalculated paths does not meet the need, it is necessary to attempt on demand calculation of a route. This can be done either for originating a call, or for propagating a call with a DTL. If a DTL is being processed, then the database must be reduced to those nodes within the scope of the current DTL entry, and the single node that is the next hop on the DTL.

The algorithm proceeds almost precisely as before except that a different link admission test is used, and a check for completion is added. (Path recording must also actively accumulate all additive metrics in a forward and backwards direction.

The new utility routine is:

```
Admit_Link(Call, Link, C, Q, path_metrics)
/* The service category comes from the call, but it is simpler to pass it as a
parameter */
if (not Admit_Link_All(Link, C, Q)) return (false);

/* Then test whether the call will fit on the link */
if (not GCAC(Call.bandwidth, Link, C)) return false;
if (not GCAC(Call.reverse_bandwidth, Links[Link].PairedLink, C))
    return (false);

/* now test the cumulative metrics */
foreach (cumulative_metric m)
    if (Outside_Range (Call.m, Cumulate(Links[Link].Classinfo[C].m,
    path_metrics[m])))
        return (false);

    if (Outside_Range (Call.m,
    Cumulate(Links[Links[Link].PairedLink].Classinfo[C].m, path_metrics[reverse+m])))
        return (false);

foreach (attribute a)
    if (Invalid_attr(Call.a, Links[Link].Classinfo[C].a)) return (false);
    if (Invalid_attr(Call.a,
    Links[Links[Link].PairedLink].Classinfo[C].a)) return (false);

return (true);
```

Reachable(Destination, Node):

If destination is a node (from a DTL) Reachable returns true if Node is that destination. If Destination is an address, Reachable returns true if Node advertises reachability to a prefix of the destination address.

Generate_routes(Dest, Call, C, Q, Tiebreakers)

/* Generate routes to the destination. The service category has been determined to be C, and Q/Tiebreakers are the selected optimization criteria */

```
integer i, j, k;
path p, q;
```

```

/* check if we are already there */
if (Reachable(Dest, This))
    /* return NIL; */
/* Due to longest match: */
save_path(NULL);

for (i = 1 to AllNodeCount) BestCosts[i] = -1;
    for (j = 1 to Pathcount)
        BestPaths[j, i] = NIL;

Tent = Empty;

i = This;
while (i > 0)
    BestCosts[i] = 0;
    i = AllNodes[i].ParentNode;

for (i = 1 to AllNodes[This].LinkCount)
    /* Make sure that the links can be used for this service category
    and optimization parameter */
    if (Admit_Link(Call, OutLinks[This,i], C, Q, NIL))
        /* The Path carries the cumulative cost for the prime condition */ p = Make_Path(This,
        OutLinks[This, i], C, Q);
        Add_to_Tent(p, C, Q, Tiebreakers);

while (not Tent_Empty(Tent))
    p = Remove_Smallest(Tent);
    i = Last_Node(p);
    k = Last_Link(p);

/* check if we have gotten there */
if (Reachable(Dest, i))
    save_path(p);
    /* it would be desirable to exit at this point. However,
    in order to enforce longest match, it is either necessary to
    know which node has the longest match for the destination
    address, or to generate all of them */

/* Check if the cost is good enough to be useable */
else if (Record_Path(p, i, C, Q, Tiebreakers))

    /* Now examine the outlinks, and put them into the tent */
    for (j = 1 to AllNodes[i].LinkCount)
        /* check if the link is useable */
        if (Links[k].PairedLink != j /* do not backtrack directly */ &&
        Admit_Link(Call, OutLinks[i, j], C, Q, metrics(p))
            q = Append_Path(p, OutLinks[i, j], C, Q);
            Add_to_Tent(q);

```

It should be noted that while this example runs the precalculation on the entire database, some implementations may choose to run it only on the lowest level peer group, or only for some sub-group of the destinations which by configuration are known to be significant. The on-demand portion of the algorithm can then be used to fill in.

It should also be noted that the correct optimization criteria for pre-calculated routes is very sensitive to the actual calls that the users are setting up. Implementers may want to consider allowing some customer choice in the selection of what to pre-calculate.

DTL Generation:

Having generated reachability paths, and inverted them into reachability tables, it is still necessary to transform a path selection into a DTL stack.

The procedure is very straight forward, and works for all known path generation algorithms:

1) Create a DTL stack with a single DTL containing only the starting node at the lowest level. Set a pointer to the start of the generated route.

Repeat the following two steps:

- 2)
 - A) If the current path entry is a regular node, add it to the DTL.
 - B) If the current path entry is a complex nodal metric entry, add the regular node it is part of to the DTL if it is not already the current entry in the DTL.
- 3)
 - A) If the link from the current entry is a horizontal link then
 - a) if it points to a complex nodal metric node, put the port number of this link in the current DTL entry
 - b) advance the pointer in the route
 - B) The link from the current entry in the route is an uplink:
 - a) End the current DTL
 - b) for each hierarchical level between the current one and the one containing the next route entry, create a single entry DTL containing the nodeid for the peer group which contains the starting node at that level
 - c) Create a new DTL with an entry for the peer group which contains the starting node at the level of the next entry in the route, and advance the route pointer
 - C) If there is no next entry in the route, you are done

This will give a DTL with those links explicitly identified which the technical analysis has said need to be called out, and no others.

29. Appendix I: Using PNNI To Connect Non-PNNI Routing Domains

PNNI may be used to connect routing domains running non-PNNI routing protocols into larger PNNI routing domains. One way for a non-PNNI routing domain to appear in a larger PNNI routing domain is by representing the non-PNNI routing domain as a single node. It can appear either as a lowest-level node, or as a logical group node. In either case, the complex node representation may be used to represent the connectivity across the non-PNNI routing domain.

The mechanisms required in non-PNNI routing protocols in order for non-PNNI routing domains to be represented as PNNI nodes are outside the scope of this specification. However, this appendix lists several requirements of PNNI nodes that may affect the operation of such non-PNNI routing domains.

If a routing domain running a non-PNNI routing protocol appears as a lowest level node in a larger PNNI routing domain:

- Connectivity must be established between all ports on the node. If the non-PNNI routing domain partitions, each partition must either become a separate lowest level node, or all links from the partition must not be advertised as reachable from the PNNI routing domain.
- The lowest-level node must be capable of exchanging topology information through the Hello protocol (over physical links and VPCs), Database Synchronization, and Flooding. The information flow over all ports must be consistent, based on the same topology database. The lowest-level node must participate in the Peer Group Leader Election.
- The lowest-level node will appear in DTLs. SETUP or ADD PARTY messages entering the lowest-level node must be routed across the current port specified in the DTL, if any, to the next node in the DTL stack.
- If the lowest-level node is capable of becoming peer group leader of its peer group, the switching system instantiating the parent logical group node must be capable of establishing and receiving SVCC-based RCCs through any of its ports, and of exchanging topology information over those SVCs through the SVCC-based RCC Hello protocol, the Horizontal Link Hello Protocol, Database Synchronization, and Flooding.

If a routing domain running a non-PNNI routing protocol appears as a logical group node in a larger PNNI routing domain:

- Connectivity must be established between all ports on the logical group node. If the non-PNNI routing domain partitions, each partition must either become a separate logical group node, or all links from the partition must not be advertised as reachable from the PNNI routing domain.
- Lowest-level Hellos on PNNI physical links and VPCs must appear as if they are attached to lowest-level border nodes contained in the logical group node.
- The lowest-level border nodes only appear in terms of the operation of outside Hellos. They must be able to create and to process nodal hierarchy lists, and to create ULIA for those links. They do not appear in DTLs, and so connectivity between the lowest-level border nodes is not required, except for satisfying the above conditions.
- The physical system instantiating the logical group node must be capable of establishing and receiving SVCC-based RCCs, and of exchanging topology information over those SVCs through the SVCC-based RCC Hello protocol, the Horizontal Link Hello Protocol, Database Synchronization, and Flooding. The LGN must participate in the Peer Group Leader Election.
- The logical group node will appear in DTLs. SETUP or ADD PARTY messages entering the logical group node must be routed across the current port specified in the DTL, if any, to the next node in the DTL stack.

Other methods for representing non-PNNI routing domains in larger PNNI routing domains are possible. Representation of a non-PNNI routing domain as multiple connected PNNI nodes is not described in this specification.

30. Appendices J to P³

These appendices can be found in [8].