

# Installation and Operating Guide

---

## VLS 4mm



Advanced Digital Information Corporation

---

---

# Copyright Notice

© Copyright *adic* 1994

The information contained in this document is subject to change without notice.

This document contains proprietary information which is protected by copyright. All rights are reserved. No part of this document may be photocopied, reproduced, or translated to another language without the prior written consent of *adic*.

*adic* shall not be liable for errors contained herein or for incidental or consequential damages (including lost profits) in connection with the furnishing, performance or use of this material whether based on warranty, contract, or other legal theory.

Printed in the U.S.A.

May 1997

Document Number 62-0075-01 Rev D

Advanced Digital Information Corporation

Telephone: (206) 881-8004

Fax: (206) 881-2296

Customer Assistance: (206) 883-HELP

World-Wide Web: <http://www.adic.com>

BBS: (206)883-3211

Shipping Address: 10201 Willows Road N.E.

Redmond, WA 98052

Mailing Address: P.O. Box 97057

Redmond, WA 98073-9757

*adic* Europe

Z.A. du Bel-Air

21-23 Avenue Saint Fiacre,

Saint Germain-en-Laye,

78100 France

33 1 3087 5300

Fax: 33 1 3087 5301

*adic* and *adic* Europe are trademarks of Advanced Digital Information Corporation.

---

## Copyright Notice (Europe)

© *Copyright 1995 ađic Europe*

All rights reserved. No part of this document may be copied or reproduced in any form or by any means, without prior written permission of ađic EUROPE, Z.A. du Bel-Air, 21 avenue Saint-Fiacre, 78100 - Saint-Germain en Laye, FRANCE.

ađic EUROPE assumes no responsibility for any errors that may appear in this document, and retains the right to make changes to these specifications and descriptions at any time, without notice.

This publication may describe designs for which patents are pending, or have been granted. By publishing this information, ađic EUROPE conveys no license under any patent or any other right.

ađic EUROPE makes no representation or warranty with respect to the contents of this document and specifically disclaims any implied warranties of merchantability or fitness for any particular purpose. Further, ađic EUROPE reserves the right to revise or change this publication without obligation on the part of ađic EUROPE to notify any person or organization of such revision of change.

Every effort has been made to acknowledge trademarks and their owners. Trademarked names are used solely for identification or exemplary purposes, any omissions are made unintentionally.

---

# EMI/RFI Compliance

## United States – FCC

**WARNING:** This equipment has been tested and found to comply with the limits for a Class B digital device, pursuant to Part 15 of the FCC Rules. These limits are designed to provide reasonable protection against harmful interference in a residential installation. This equipment generates, uses, and can radiate radio frequency energy and, if not installed and used in accordance with the instructions, may cause harmful interference to radio communications. However, there is no guarantee that interference will not occur in a particular installation. If this equipment does cause harmful interference to radio or television reception (which can be determined by turning the equipment off and on) the user is encouraged to try to correct the interference by one or more of the following measures:

- Re-orient or relocate the receiving antenna.
- Increase the separation between the equipment and receiver.
- Connect the equipment into an outlet on a circuit different from that to which the receiver is connected.
- Consult the dealer or an experienced radio/TV technician for help.

You may find the following booklet prepared by the Federal Communications Commission helpful: *How to Identify and Resolve Radio-TV Interference Problems*. This booklet is available from the U.S. Government Printing Office, Washington, DC 20402, Stock No. 004-000-00354-04.

## Canada – Department of Communications

This digital apparatus does not exceed the Class B limits for radio noise emissions from digital apparatus as set out in the interference-causing equipment standard entitled "Digital Apparatus", ICES-003 of the Department of Communications.

Cet appareil numérique respecte les limites de bruits radioélectriques applicables aux appareils numériques de Class B prescrites dans la norme sur le matériel brouilleur: "Appareils Numériques", NMB-003 édictée par le ministre des Communications.

## Shielded Cables

Shielded data cables are required in order to meet EMI/RFI limit specifications. The *ad/c* data cable meets this requirement. If you need a replacement cable, be sure to use an *ad/c* - approved shielded cable (to assure acceptability to EMI/RFI requirements).

Two or more VLS units cabled to each other on the same SCSI channel must have a ferrite bead clamped on the interface cable between the units. The ferrite bead is required to satisfy the EMI/RFI limit specification. See Appendix A for instructions on installing the ferrite bead.

# Declaration of Conformity

according to EN 45014

Manufacturer's Name: Advanced Digital Information Corporation

Manufacturer's Address: 10201 Willows Road NE 21-23 Av. Saint-Fiacre  
Redmond, WA 98052 F-78100 Saint-Germain-en-Laye  
USA France

declares, that the product:

Product (Produit, Erzeugnis): Virtual Library System

Model Number (Marque Commercial, Warenbezeichnung): VLS 4mm

conforms to the following international specifications, as required by 89/336/EEC & 92/31/EEC:

EMI: EN 50081-1, EN-55022 Class B

EMC: EN 50082-1, IEC 801-2, IEC 801-3, IEC 801-4

Safety: EN 60950

Supplementary Information:

Redmond, Washington USA

3-Jan-1996



Project Engineering Mgr

**Location**

**Date**

**Signature/Title**

---

## Safety Warnings

### **Caution**

All safety and operating instructions should be read before this product is operated, and should be retained for future reference. This unit has been engineered and manufactured to assure your personal safety. Improper use can result in potential electrical shock or fire hazards. In order not to defeat the safeguards, observe the following basic rules for its installation, use and servicing.

1. Heed Warnings - All warnings on the product and in the operating instructions should be adhered to.
2. Power Source - The product should be connected to a power source only of the type directed in the operating instructions or as marked on the product.
3. Power Cord Protection - The AC line cord should be routed so that it is not likely to be walked on or pinched by items placed upon or against it, paying particular attention to the cord at the wall receptacle, and the point where the cord exits from the product.
4. Power Switch - The power switch used in this product does not disconnect both supply conductors when placed in the **OFF** position. To completely disconnect power from this product, unplug the AC power cord from the receptacle on the back of the unit.
5. Servicing - The user should not attempt to service the product beyond that described in the operating instructions. All other servicing should be referred to qualified service personnel.

---

# Table of Contents

Copyright Notice.....	ii
Copyright Notice (Europe).....	iii
EMI/RFI Compliance.....	iv
Safety Warnings .....	vi
Quickstart.....	ix
Chapter 1: Getting Started.....	1
Introduction.....	2
Requirements.....	2
Unpack and Inspect .....	3
Equipment Description .....	4
The VLS Unit .....	4
Magazine.....	4
Media .....	5
Cleaning Cassette.....	6
System Software.....	6
Preparing the Host Computer System.....	7
Power Off the Computer .....	7
Confirm and/or Install the SCSI Host Interface.....	7
Chapter 2: Connecting the VLS .....	9
Connecting the Interface Cables.....	10
Connecting More Than One VLS.....	12
Powering on the System.....	13
Installing the Backup Software .....	14
Chapter 3: Equipment Description.....	15
Front Panel Switches and Indicators.....	16
Rear Panel Switches and Connectors.....	18
Menu Items .....	18
Configuration Menu .....	20
Buzzer Configuration .....	20
SCSI ID Config.....	21
SCSI Parity .....	22
Off-Line Time .....	22

---

Drive Configuration.....	23
On-Line Mode.....	23
Sequential-Access Mode Configuration.....	24
Diagnostics Menu.....	25
Write EEPROM Mode.....	26
Chapter 4: Operation and Maintenance.....	27
DDS-2 Media.....	28
Inserting Data Cassettes into the Magazine .....	29
Inserting the Magazine into the VLS .....	31
Loading the Magazine .....	33
Attempting to Load the Magazine with a Cassette Already in Drive.....	34
Manually Removing a Cassette Loaded in the Drive .....	35
Removing the Magazine from the VLS.....	36
Removing the Magazine while a Cassette is in the Drive .....	37
Loading an Individual Cassette .....	37
Removing a Cassette from the Magazine.....	39
Storing the Magazine.....	39
Cleaning the Drive Head.....	39
Cleaning the Enclosure .....	43
Chapter 5: Troubleshooting and Diagnostics.....	45
VLS Error Messages .....	46
Error Messages .....	47
Drive Warning Signals .....	49
Environmental Considerations.....	52
When You Call ADIC Customer Assistance.....	52
Return for Repair RMA (Return Merchandise Authorization).....	54
Appendix A: Installing the Ferrite Bead.....	55
Appendix B: Diagnostics Menu .....	57
Appendix C: Glossary .....	65
Appendix D: Specifications .....	71
Index .....	75



---

## Quickstart

### This Section ...

- provides a quickstart guide for experts who are familiar with installing computer hardware and software.

---

### Note

The VLS has been shipped with the SCSI ID for drive A set at "1", drive B set at "2" and the robotics set at "3".

- ❑ Confirm that power is off and that you have a SCSI interface (either a separate board as offered by **adic** or integrated on the mother-board) installed in the host computer. Consult your computer manual.
- ❑ Place the **adic** VLS near the host computer to which it will be connected.
- ❑ Connect the SCSI interface cable between the SCSI connectors on the computer and the back of the VLS.

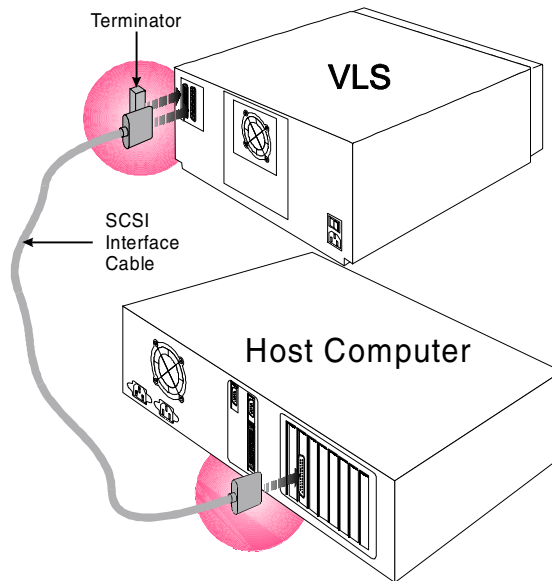

- ❑ Make sure there is a terminator installed on the last device of the SCSI chain.

---

### Note

adic recommends the use of an "Alt-2" active single ended terminator such as adic p/n 61-1124-01.

- ❑ Connect the AC power cord first to the VLS and then to the AC outlet. Power on the VLS. Power on the host computer.

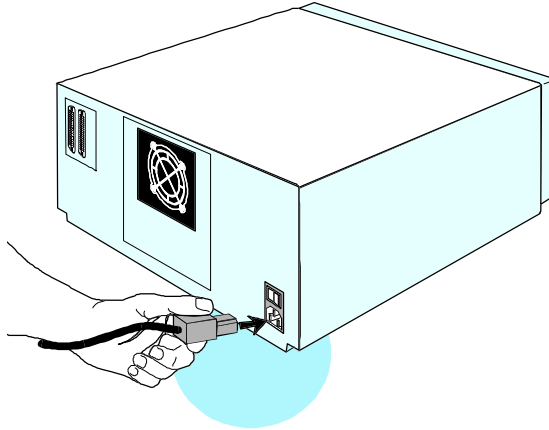

- ❑ Place the magazine on the carriage by slipping it over the left "magazine position" pin and then rotating toward the right and pressing into place on the right "magazine position" pin.

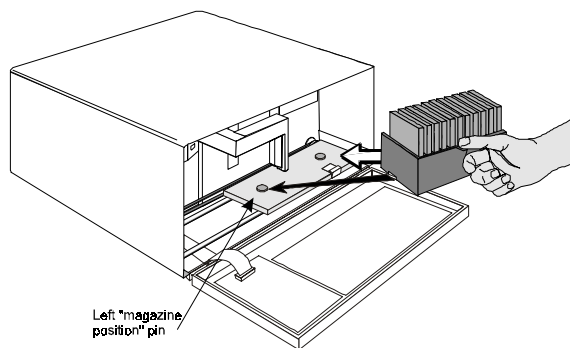

- ❑ If the application has not already done so, load the magazine by pressing first the **ALT** button and then the **LOAD** button. (If you are in sequential mode, the first cassette will be inserted in the drive when the load finishes.)

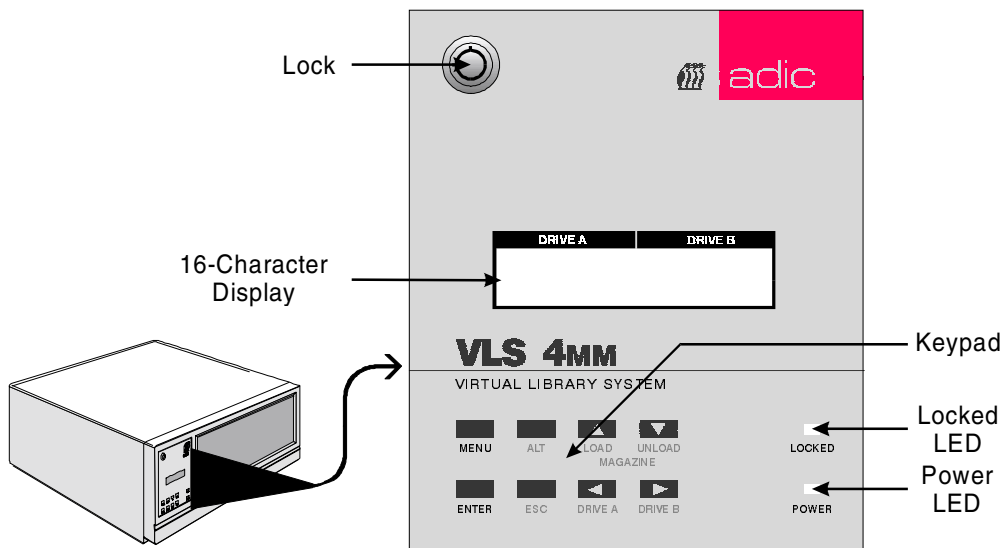

- ❑ Install or confirm the backup software (to run the VLS) on the host computer.
- ❑ Run any diagnostic tests provided with the backup software to make sure the VLS is communicating correctly with the host computer.

You are now ready to run the VLS at a system level.

# Chapter 1

---

## Getting Started

### This Chapter ...

- ❑ covers what you need (and what you need to know) to install the **adlc** Virtual Library System. Read this section before you begin installation.

---

## Introduction

The Virtual Library System (VLS) is designed for high-capacity, near and off-line storage applications, backup, hierarchical storage management (HSM), and video/design/data file libraries. For the most part, installation is simply a matter of checking all necessary SCSI connections, installing the software (backup or otherwise) and applying power. The defaults set at the factory should be sufficient for most applications.

---

## Requirements

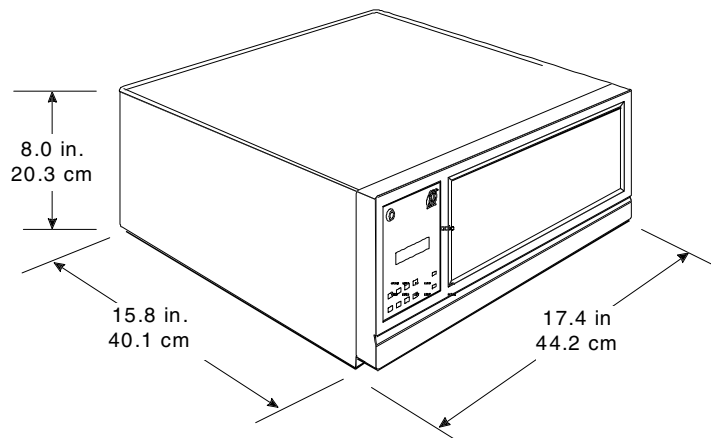

- Space requirements: the VLS has a footprint of 17.4" x 15.8". You must allow adequate clearance to the rear and bottom to allow air flow and enough room at the front to open the door which stands 8" high and is hinged at the bottom.
- We assume that you are familiar with your computer system. The VLS must be incorporated into the host computer system. The backup software, SCSI interface and SCSI interface cable(s) must be purchased separately.
- Mode of operation: You must know whether the VLS will be operating in sequential or random-access mode. This will be determined by the backup software you use.

- 
- ❑ Necessary tools: No special tools are required to install the VLS. If you are installing a host adapter (SCSI controller) card at this time, refer to the installation manual for your host adapter.

---

## Unpack and Inspect

**Caution**

If the operating environment differs from the storage environment by 15° C (30° F) or more, let the unit acclimate to the surrounding environment for at least 12 hours.

- ❑ Unpack all items from the carton. Save the packing materials in case you need to move or ship the system in the future.

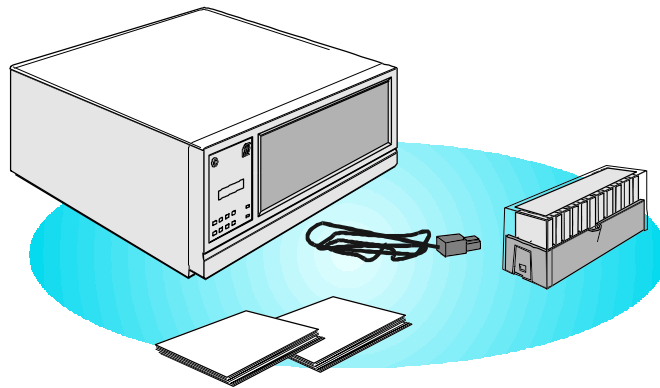

**Caution**

You must ship the  VLS in the original or equivalent packing materials or your warranty may be invalidated.

---

## Equipment Description

---

### The VLS Unit

The *adic* VLS is a fully automated, high performance, high capacity, mass storage system designed with a removable data cassette magazine. The door can be locked to deactivate the unit's keypad, assuring only authorized removal of the magazine and media. In addition, to protect the unit, data and media, the VLS will not operate unless the door is closed.

---

### Magazine

**Note**

*adic* strongly recommends that you use *adic* approved data-grade media only. Do not attempt to use "audio-grade media" (such media can damage the heads and tape handling parts – voiding your warranty).

The magazine for the VLS holds fifteen 4mm cassettes. It includes a clear dust cover to protect the cassettes and for ease of storage. Figure 1 shows a 4mm cassette and a filled magazine with the cover in place.

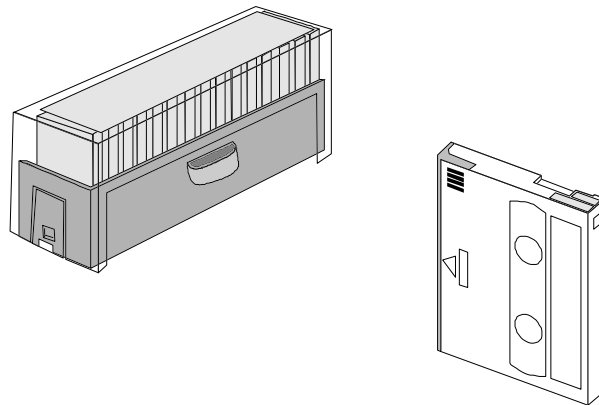

Figure 1. VLS Magazine for 4mm Cassettes



---

## Media

The 4mm VLS uses 4mm DDS data cassettes. Before inserting the cassette into the magazine check the position of the write-protect switch. Set all switches to the enabled position – hole closed (refer to Figure 2). (The write-protect switch enables or disables the ability to write [or delete] files on the data cassette.)

### Caution

Only cassettes labeled "DDS" should be used. *Never* use audio DAT cassettes, because the media is not certified. Also, DAT cassettes have a different mechanical specification which can cause them to jam in the mechanism.

- ❑ To write-protect the data cassette, move the write-protect switch away from the edge of the data cassette, as shown in Figure 2. If the hole is open, the cassette is write protected and cannot be written to (or erased).
- ❑ To write-enable the data cassette, move the write-protect switch toward the edge of the data cassette, as shown. If the hole is closed, the data cassette is write enabled and can be written to or erased. Use a ball-point pen or similar instrument to set the write-protect switch.

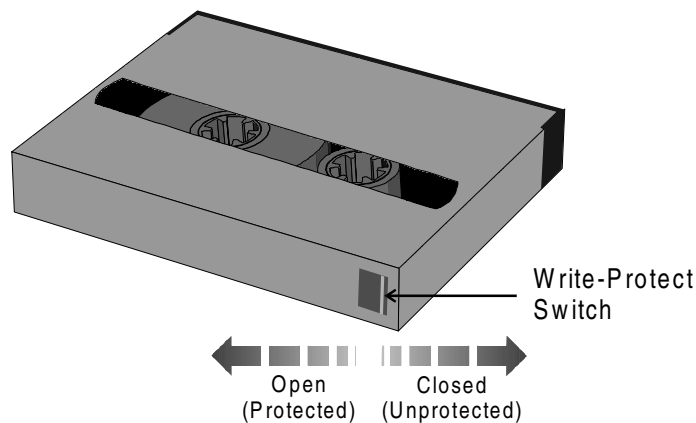
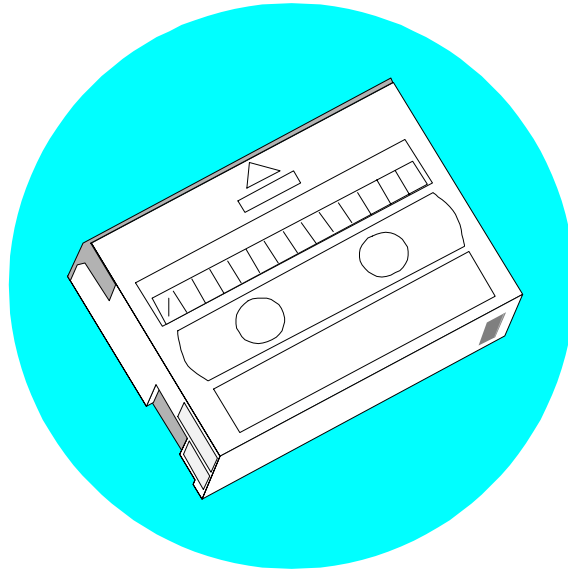

Figure 2. 4mm Cassette Showing Write-Protect Switch

---

## Cleaning Cassette

The tape heads should be cleaned after every 8 to 10 hours of tape motion or when the Media Caution indication is displayed. A cleaning cassette (ADIC 39-1028-01) is shipped with your **adic** VLS. Discard it after approximately 20 uses and replace it with the same or equivalent type cleaning cassette. See *Cleaning the Drive Head* later in this manual.



*Figure 3. 4mm Cleaning Cassette*

---

## System Software

A variety of backup and data storage software is available for use with the VLS. Please check with **adic** Sales or Customer Assistance if you have a question on the compatibility of a particular software package.

---

## Preparing the Host Computer System

---

### Power Off the Computer

- Turn off the power switch.
  - Unplug the cord from the AC outlet.
- 

### Confirm and/or Install the SCSI Host Interface

The VLS must be connected to either an integrated SCSI host or a SCSI interface (host adapter) card installed in the computer – either directly to the I/O connector on the card or as part of an existing SCSI chain. The SCSI interface must be installed before you connect the VLS. Refer to the instructions supplied with your selected SCSI interface.

Now you are ready to connect the VLS to your host computer. Follow the instructions provided in the next chapter.

**Note**

*The host computer system normally is the server.*

---

**Blank Page**

# Chapter 2

---

## Connecting the VLS

This Chapter ...

- provides instructions for physically connecting your VLS to your host system.
- steps you through the final phase of the installation process.

---

## Connecting the Interface Cables

**Note**

The interface cables must be shielded – **adic** can supply you with the correct type(s).

Make sure the interface cable you are using has the appropriate connectors on each end. If the host computer's SCSI connector is different from that on the VLS, you will need to obtain a different cable than the one supplied with the unit. Consult your dealer or **adic** Customer Assistance if you need help. Connect the interface cables as shown in Figure 4 and explained in the following steps:

- ❑ Check that the power switches on both the VLS and the host computer are off.
- ❑ Attach one end of the SCSI interface cable to either connector on the rear of the VLS. Press firmly and secure the bail locks.

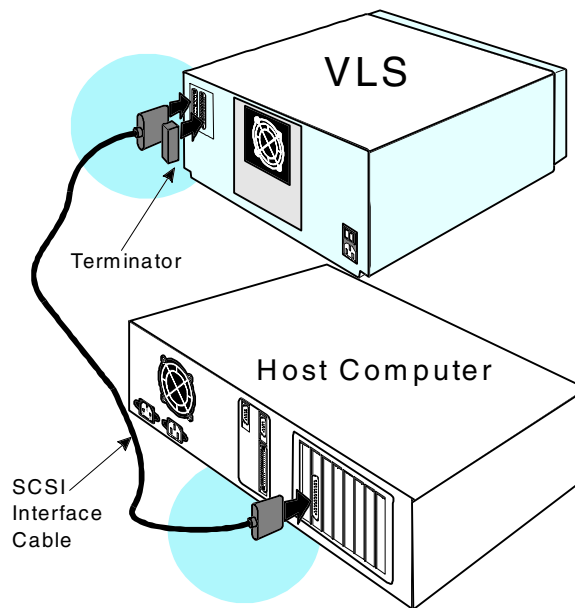

Figure 4. Connecting the Interface Cables

---

**Note**

The bail locks at both ends of the SCSI cable must be securely fastened in order for the VLS to communicate properly with the computer.

- ❑ Plug the other end of the SCSI interface cable into the external connector on the SCSI port card. Secure firmly.
- ❑ If this is the only unit you are installing, insert an external terminator plug into the second SCSI connector at the rear of the VLS. If you plan to connect another unit on the same SCSI channel, see the next section.

---

## Connecting More Than One VLS

If you are connecting additional VLS units on the same SCSI channel, simply attach each subsequent unit to the previous unit with an interface cable. Make sure all cables are properly secured. You can attach up to seven devices on each SCSI channel.

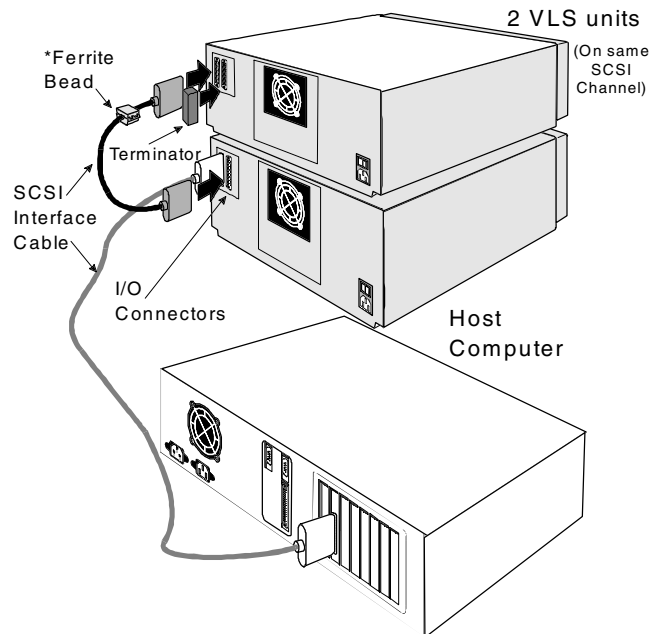

Figure 5. Cable Diagram for two VLS Units

### Note

\* When connecting two or more VLS units to a single SCSI channel, you must install a ferrite bead on the cable. Refer to Appendix A for details.

Each VLS unit contains more than one SCSI device and may require more than one SCSI ID (depending on the mode of use and number of drives). The first chart below shows various configurations and the number of SCSI IDs required. The second chart illustrates how many VLS units you can attach to one SCSI channel (if there are no other devices on the channel).



---

**Note**

When counting SCSI devices, keep in mind that a VLS can contain up to three devices (Drive A, Drive B and the robotics). Don't forget to include in your count other devices on your SCSI channel (i.e., a tape unit, an additional hard drive, etc.).

VLS	Number of SCSI IDs Required	
	Sequential Mode	Random Mode
One drive	1	2
Two drives	N/A	3

VLS	Maximum VLS units on one Channel	
	Sequential Mode	Random Mode
One drive	7	3
Two drives	N/A	2



---

## Powering on the System

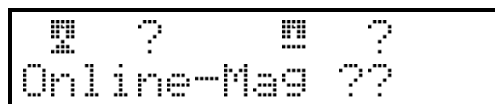

- Plug the power cord into the back of the VLS.
- Plug the power cord from the VLS into a grounded electrical outlet.
- Plug the power cord from your host computer into a grounded electrical outlet.
- Turn on the VLS power. Turn on the host computer power.



A display similar to the following will appear on the VLS display:



The top line of the LCD is logically divided into a Drive A side (left), and a Drive B side (right). When the VLS is in the On-Line mode, the LCD displays the current status of the drives on the top line. The  symbol indicates that the drive is configured, on-line, and is aligned with the Media Picker. The  symbol indicates that

---

the drive is configured and on-line, but is not aligned with the Media Picker. The  symbol indicates that there is no *configured* drive in that position. The  in the 5<sup>th</sup> character position for each drive indicates that the VLS does not know if a cartridge is currently loaded in that drive. If the VLS had loaded a cartridge into a drive prior to shut-down, this character and the one preceding it would reflect the slot number of the magazine that the cartridge was loaded from (01 to 15). The 7<sup>th</sup> character position may display a  symbol, indicating that the drive is actively writing or reading.

The bottom line of the LCD, when the VLS is in the On-Line mode, displays the current status of the magazine. The  characters indicate that the VLS does not know the current status of the magazine. This is normal immediately following power-up. If the magazine had been loaded prior to shut-down, the VLS would display  when repowered..

You are now ready to install the backup software – if it has not already been installed.

---

## Installing the Backup Software

At this point you need to refer to your software installation guide for instructions on installing the backup/controlling software for the VLS onto the host computer.

After you have completed installation of the VLS and the backup/controlling software, make sure that your unit is operating correctly by running any diagnostic test(s) supplied with the backup software.

# Chapter 3

---

## Equipment Description

### This Chapter ...

- describes the switches, indicators and connectors on the front and rear of the VLS.
- describes the various functions available via the front panel buttons.
- describes the power-up procedure and messages on the front panel LED display.

---

Once your VLS has been connected to your host computer system and the software has been installed, the VLS is ready for use. Just turn on the power switch, place a magazine on the carriage and press **ALT** and then **LOAD**.

**Note**

This is the software that runs the VLS, not the data being transferred to the VLS cassettes. Two examples of backup software are Cheyenne's ARCserve and Legato's NetWorker.

If you need to change certain operating functions, you can use the front panel buttons (as described in the next section).

---

## Front Panel Switches and Indicators

Switches and indicators on the front of the VLS are shown in Figure 6.

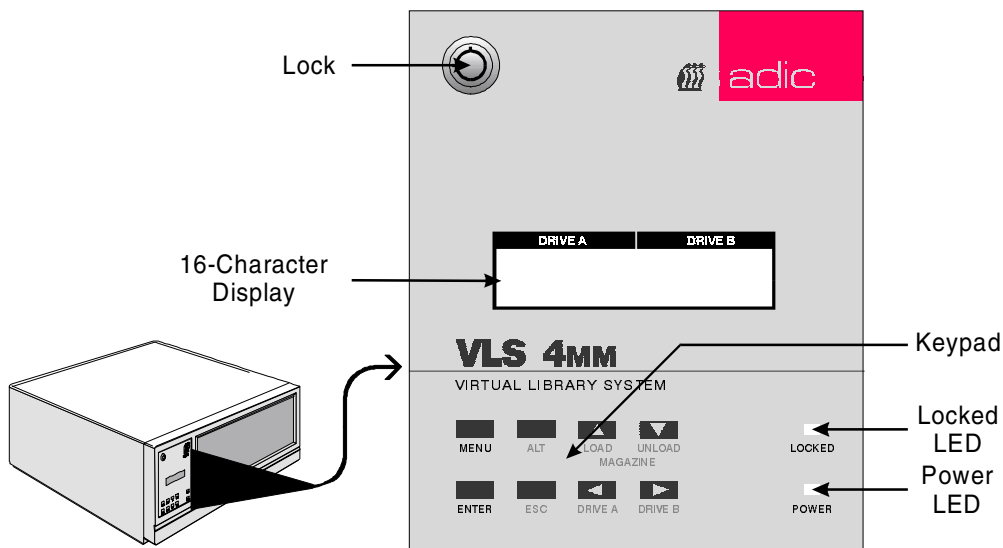



Figure 6. Front of ADIC VLS

- Lock** In the locked position, you cannot access any functions of the keypad.
- Display** The two-line 16-character LCD shows current drive status of the VLS, allows access to change features or displays error messages.

---

<b>Power LED</b> (green)	Lights when power is on.
<b>Locked LED</b> (green)	Lights when door is locked. The magazine, drive, or keypad cannot be accessed while the Locked LED is on.
<b>MENU</b>	Press this button to enter or exit Off-line mode menus
<b>ALT</b>	Selects alternate function for another button. For example, press the <b>ALT</b> button and the <b>UP</b>  button to activate the load function.
<b>Up</b> 	Selects previous item or value in the menu.
<b>LOAD</b>	Press the <b>ALT</b> button and then this button to initiate a "load magazine" – the VLS will check all cassettes in the magazine (making note of empty spaces) and that all cassettes can be inserted in the drive.



**Note**

*The VLS uses the LOAD function to detect cassettes (or the absence of a cassette).*

<b>Down</b> 	Selects next item or value in the menu.
<b>UNLOAD</b>	Press the <b>ALT</b> button and then this button to initiate the unload program – the VLS will return the magazine to the unload position.

**Caution**

Never attempt to remove a magazine unless it is in the unload position – you may damage the pick arm.

<b>ENTER</b>	Selects currently displayed item.
<b>ESC</b>	Exits current menu and returns to previous menu.
<b>Left</b> 	Scrolls message display to the left or selects previous field on same line.
<b>DRIVE A</b>	Press the <b>ALT</b> button and then this button to select drive A.
<b>Right</b> 	Scrolls message display to the right or selects next field on same line.
<b>DRIVE B</b>	Press the <b>ALT</b> button and then this button to select drive B.

---

## Rear Panel Switches and Connectors

Switches and connectors on the rear of the VLS are shown in Figure 7.

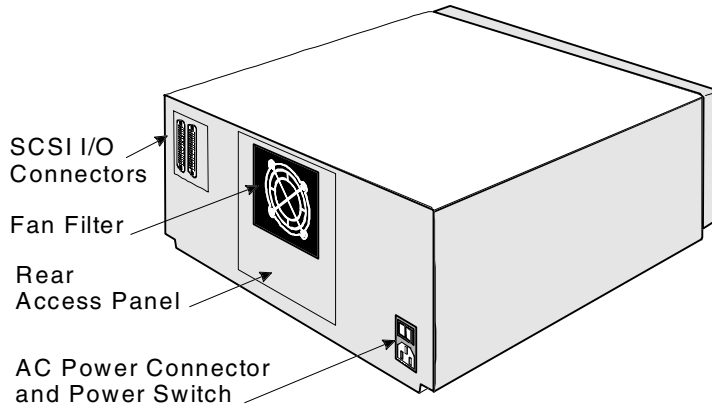

*Figure 7. Back of ADIC VLS*

<b>Power Switch</b>	Turns on the AC power to the VLS.
<b>AC Power Connector</b>	Plug the VLS AC power cord into this connector.
<b>SCSI I/O Connectors</b>	Connections for the interface cable which connects the VLS to the computer, to other VLS units and/or to other devices on the SCSI channel.

---

## Menu Items

The menus and mode shown at the top of the following diagram are selections available from the Main Menu. When you choose one of the Main Menu items, a set of options appears; these options are listed below the Main Menu selections. If an option has sub-options, these sub-options are listed below and to the right of the option.

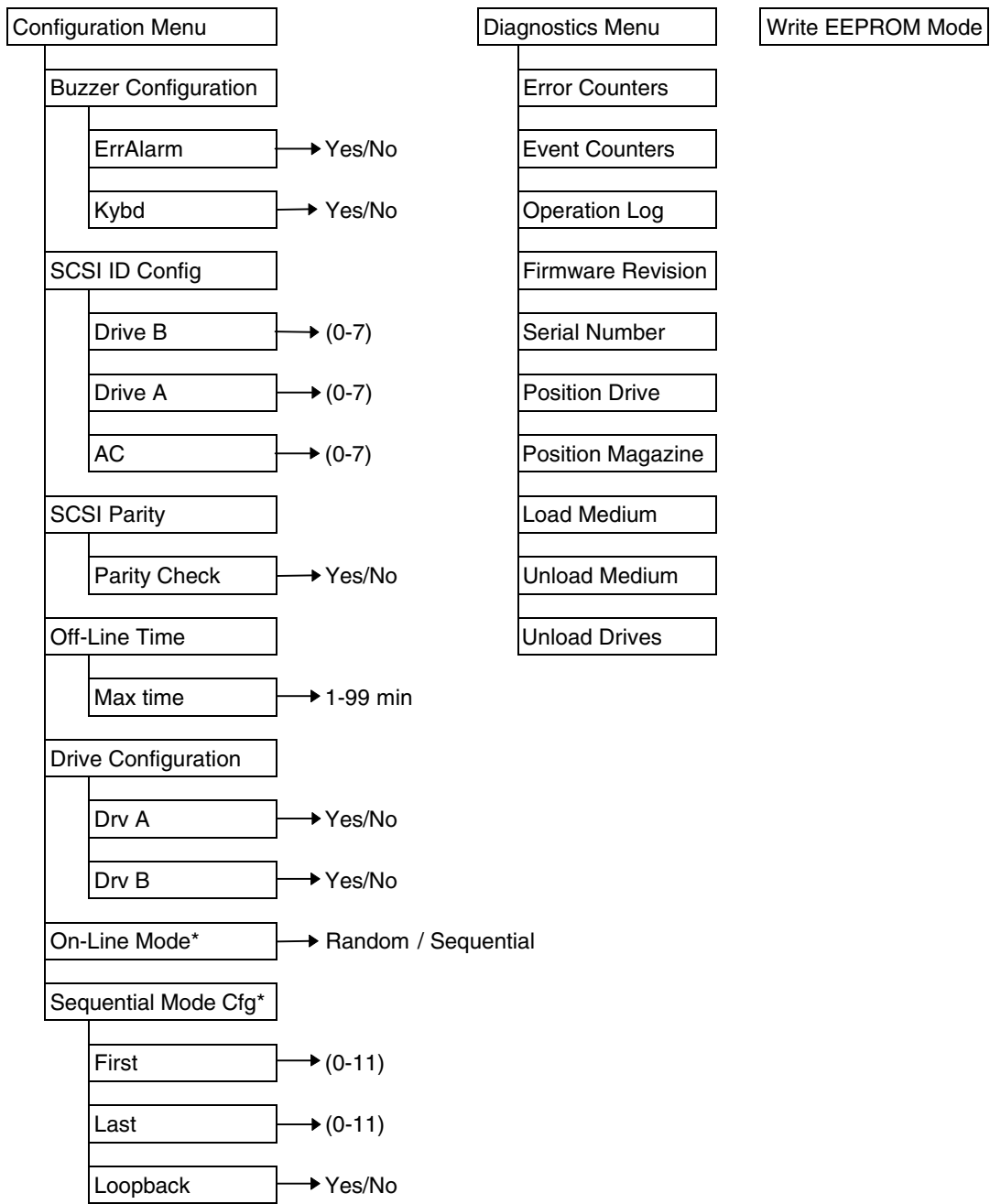





\* Available only when VLS is configured as a single-drive unit.

---

To access the Off-Line menu, press the **MENU** button. The display will appear as follows:



```
OFF-LINE MENU
Config Menu  →
```

Use the **UP**  or **DOWN**  buttons to scroll through the menu. Press **ENTER** to select a displayed item. Use the **RIGHT**  or **LEFT**  buttons to scroll through fields on the same line.

To exit the Off-Line menu press the **MENU** button.

---

## Configuration Menu

The Configuration Menu allows you to select the following operating parameters:

- Buzzer Configuration
- SCSI ID Configuration
- SCSI Parity
- Off-Line Time
- Drive Configuration
- On-Line Mode (Single Drive models only)
- Sequential-Access Mode Configuration (Single Drive models only)

### Buzzer Configuration

Enables/disables the sounding of an alarm when an error message is displayed.  
Enables/disables the beep sound when you press a keypad button.



When you select the Buzzer Configuration option a display similar to the following appears:





```
BUZZER CONFIG
ErrAlarm:N Kybd:
```



---

To enable the error alarm use the **LEFT**  button to select the ErrAlarm field. Use **UP**  or **DOWN**  to select "Y" to enable alarm or "N" to disable alarm. When Error Alarm mode is enabled, a continuous alarm tone will sound in the event of an error message. The alarm will sound until the condition that caused the error has been removed or any key is pressed. To clear an error message from the display, press **ALT** and **ENTER**.

If you wish to change the status of the keyboard beep, use the **RIGHT**  button to select the Kybd field. Use **UP**  or **DOWN**  to select "Y" to enable a beep when you press a button or "N" to disable the beep. Press **ENTER** to make the changes effective or press **ESC** to return to previous menu item.





**Note**

Buzzer Configuration default: Err Alarm: N, Kybd: Y

### SCSI ID Config

Lets you select the SCSI ID for drive A, drive B and the robotics on the VLS.

```
SCSI ID CONFIG
DA:1 DB:2 AC:3
```

Use **LEFT**  or **RIGHT**  to select the desired field. DA is Drive A, DB is Drive B and AC is the robotic unit (autochanger) on the VLS. Use **UP**  and **DOWN**  to scroll to the desired ID for that particular element. Press **ENTER**.

**Notes**

SCSI ID changes entered do not take effect until you cycle power on the VLS unit.

SCSI ID Configuration default: Drive A:1, Drive B:2, AC:3



See the section in Chapter 2 noting the SCSI IDs needed for the VLS.

---

## SCSI Parity

Lets you enable or disable the reporting of SCSI parity. Press **ENTER** to access this function.

```
SCSI PARITY
Parity Check:N
```

Use **UP**  or **DOWN**  to select "Y" to enable the reporting of parity check or "N" to disable the reporting of parity check. Press **ENTER** to activate the change.



### Note

SCSI Parity default: Parity Check: N

## Off-Line Time

Lets you set the number of minutes the VLS will remain in the Off-Line mode. If someone leaves the VLS in an Off-Line mode, after the pre-set number of minutes the VLS will automatically return On-Line. This assures that your automatic backup will be done even if the VLS has accidentally been left Off-Line.

```
OFF-LINE TIME
Maxtime:5 min
```

Use **UP**  or **DOWN**  to select the number of minutes you wish the VLS to remain Off-Line. Press **ENTER** to execute the change.

### Note





Off-line time default: "5" minutes.

---

## Drive Configuration

This function lets you enable or disable which drives are on-line.

```
DRIVE CONFIG
Drv A:Y Drv B:Y
```

Use **LEFT**  or **RIGHT**  to select the drive you wish to change. Use **UP**  or **DOWN**  to select "Y" to put the drive on-line or "N" to disable the drive. If you have only one drive installed, you cannot access the Drv B field.

### Note

A disabled drive is still connected to the SCSI bus and will respond to the last address setting. To assure that address changes and drive configuration changes are fully initiated, you must cycle power.

Disabling both drives is not allowed (setting "N" in Drv A or Drv B field automatically places "Y" in the other field).

### Note

Drive Configuration default setting is "Y" for each installed drive.

## On-Line Mode

Lets you select random-access or sequential-access operating mode.

When used in random-access mode, the VLS allows software selection of *any* cassette in the magazine in *any* order. You can logically divide cassette usage to satisfy particular data storage needs. For example, you can assign one or more cassettes to specific data functions (such as certain directories or network servers), or you can assign specific cassettes to individual users.



---

**Note**

If you have both drives on line, you will not be able to access this function. The software you use with the VLS determines whether you can operate the VLS in sequential and/or random mode.

adic's VLS can also be used as a stacker in sequential-access mode if your software does not support the random-access mode function.

```
ON-LINE MODE
Mode: RANDOM
```

Use **UP**  or **DOWN**  to select "random" or "sequential".

**Note**

Operating Mode default setting is "Random".



### Sequential-Access Mode Configuration

If you are using Sequential-Access Mode, this option lets you select which cassettes the drive will write to, and whether or not you wish the drive to start again at the beginning after the last cassette has been written to.

**Note**

If you have a dual-drive system and both drives are on line, you will not be able to access this function.

```
SEQ MODE CFG
F:01 L:15 Lpbk:Y
```

Use **LEFT**  or **RIGHT**  to select the item you wish to change. "F" is the number of the First cassette you wish the VLS to insert into the drive. "L" is the number of the Last cassette you wish the VLS to insert into the drive.

---

The Loopback (LPBK) mode determines what happens when the last cassette has been filled. If you select "Y" for "Lpbk" the designated first cassette will be loaded into the tape drive after the last cassette has been filled and ejected. If you select "N" an error message will be issued and the backup will stop.

**Note**

Default setting is F: 01 L: 11 Lpbk: Y

---

## Diagnostics Menu



```
OFF-LINE MENU
Diag Menu      ▸
```

The following functions are available under the Diagnostics Menu:

- Error Counters
- Operation Log
- Serial Number
- Position Magazine
- Unload Medium
- Event Counters
- F/W Revision
- Position Drive
- Load Medium
- Unload Drives

For information on these options, refer to Appendix B.

**Warning**

We highly recommend that these diagnostic functions be used only by a qualified service technician (or on the instruction of a qualified technician). Some of these functions assume that the unit has been set up correctly and thus many of the normal built-in safety checks are turned off. Misusing these diagnostic functions without the normal safety checks could result in improper operation (or even damage to media or VLS).

---

## Write EEPROM Mode



```
OFF-LINE MENU
Write EEPROM
```

The Write EEPROM Mode is used whenever you upgrade the VLS firmware. Refer to Appendix C in this manual for additional information.

# Chapter 4

---

## Operation and Maintenance

This Chapter ...

- describes normal operation features of the VLS
- provides details on the media and magazine
- explains normal maintenance procedures

---

The VLS unit is composed of one or two DAT drives and the robotics that control the drive(s), magazine and media. The drive(s) are unmodified. The drive status LEDs function per the manufacturer's specifications.

No routine maintenance is required – apart from cleaning the heads after approximately each 8 to 10 hours of tape motion or when the Media Caution indication is displayed on the drive LEDs (see *Cleaning the Drive Head* later in this manual).

**Note**

Since the drive status LEDs are located on the lower front of the drive, to see them you must be eye-level with the gripper arm of the VLS. Look beyond the arm to the drive.

---

## DDS Media

Use only industry-standard 4mm DAT cassettes with the VLS. These data-grade cassettes are manufactured under more stringent environmental, reliability and durability specifications than audio-grade cassettes, producing superior data reliability. The 125-meter cassettes, used only in DDS-3 drives, and the 120-meter cassettes, which can be used in both DDS-3 and DDS-2 drives, are marked with the DDS-3 and DDS-2 logos, respectively.

A write-protect switch is used to prevent recording over existing data. To prevent recording or deleting, place the write-protect switch to the open position. The drive senses the position of the switch and will not allow writing in this position. When inserting cassettes in the magazine, place the switch in the closed position (unless you do not wish to record on a specific cassette).



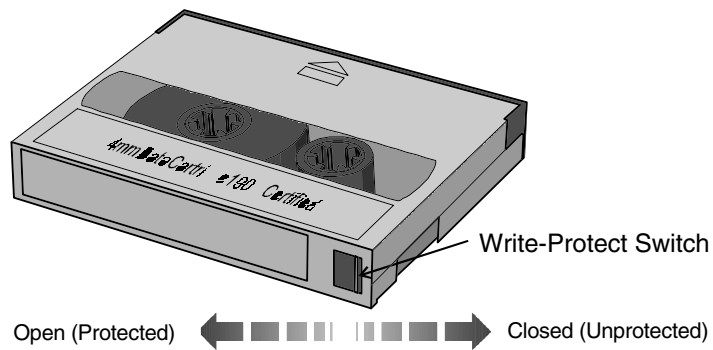

---

## Inserting Data Cassettes into the Magazine

The magazine for the 4mm VLS holds fifteen 4mm cassettes. It includes a clear dust cover to protect the cassettes and for easy storage. See Figure 8. Insert each cassette into a slot of the magazine making sure that the write-protect tab is on the top and the cassette faces toward you when the magazine is loaded onto the carriage of the VLS (as illustrated).

A spring holds each cassette in place even if the magazine is turned upside down.

### **Note**

*adic strongly recommends that you use adic-recommended data-grade media only. Do not attempt to use "audio-grade" media (such media can damage the heads and tape handling parts – voiding your warranty).*

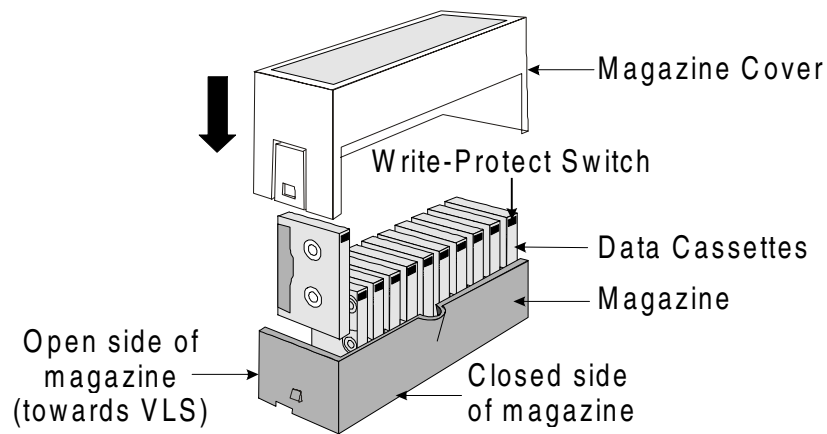

*Figure 8. VLS Magazine*

The open side of the magazine faces the VLS. Make sure each cassette touches the bottom floor of the magazine.

Do not use wrap-around labels on the individual cassettes. Most labels use a removable adhesive and have a tendency to curl or tear after multiple uses. This can jam the movement of the VLS. Place labels only in the space provided on the cassette.

Note the following:

- Store magazines (and data cassettes) in a dry, cool environment. Keep the dust cover on the magazine.
- Never reset or power down your computer or VLS while a function is in process or a tape is moving. In addition to getting tape with missing or corrupted data, you may also get tape run-on within the drive (a condition that can produce internal contamination requiring factory cleaning).
- If a power outage occurs during a back-up sequence, restart your backup from the beginning.

---

## Inserting the Magazine into the VLS

**Note**

*Do not attempt to place a covered magazine onto the VLS carriage.*

- ❑ Remove the magazine cover. You can remove the cover by pressing the middle of both ends (where it is labeled PUSH) and lifting up (see Figure 9).

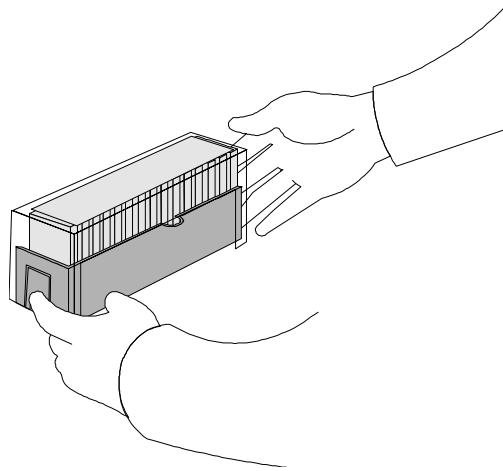

*Figure 9. Removing the Magazine Cover*

- ❑ Open the VLS door.
- ❑ Holding the magazine by the thumbhole handle, and at a 45° angle to the carriage, slip the magazine onto the left side of the carriage, over the magazine position pin (see Figure 10).

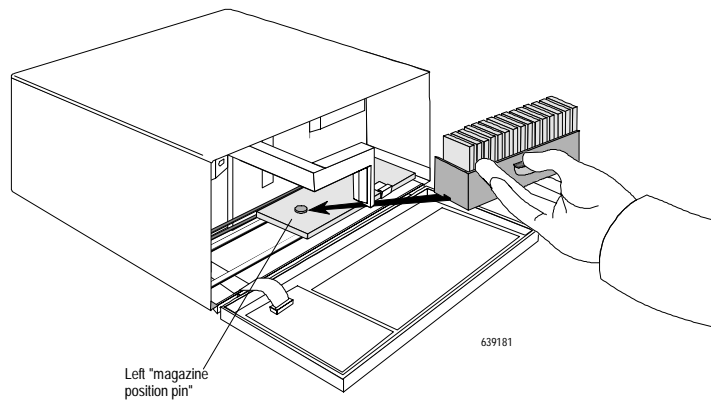
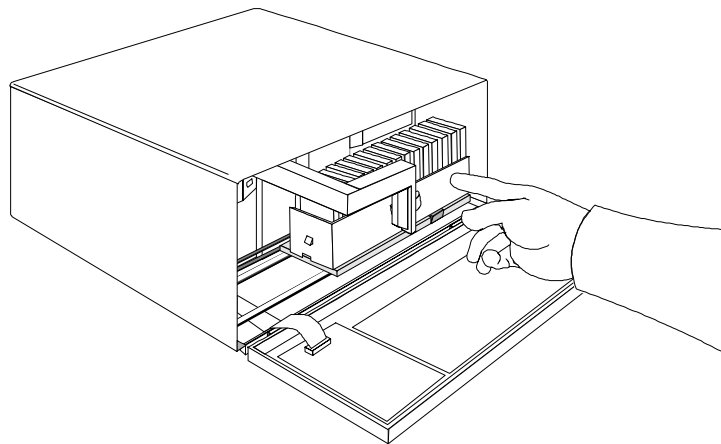

*Figure 10. Placing the Magazine onto the VLS*

- ❑ Push the right side of the magazine over the right hand magazine position pin until you hear a click. See Figure 11.

**Note**

You may need to apply downward pressure as you slip the magazine over the right magazine pin, and then press the magazine into place with your index finger.



*Figure 11. Pushing the Magazine in Place*

---

The magazine will snap into place. If you don't hear a click, make sure that the slot on the right side of the magazine has slipped around its magazine position pin and is not just sitting on top of it. The magazine will not load correctly in this position.

---

## Loading the Magazine

Once you have placed the magazine on the carriage, the VLS must initiate a loading process. During this procedure the VLS checks and maps the position of each cassette and makes sure that all cassettes are inserted into the magazine correctly. If you are using the sequential mode the VLS inserts the first cassette into the drive.

**Note**

The door must be closed before the **LOAD** or **UNLOAD** functions will activate.

- Make sure the magazine is placed correctly on the carriage.
- Close the door and press **ALT** and then **LOAD**. The VLS will initiate the load magazine procedure.

**Note**

In the *sequential mode*, if you press **UNLOAD** before the VLS has finished loading the magazine, the robotics will finish mapping and checking the cassettes and then move the magazine to the unload position (the far right) without inserting a cassette into the drive.

In *random mode*, if you press **UNLOAD** before the VLS finishes loading the magazine, it will have no effect.

---

## Attempting to Load the Magazine with a Cassette Already in Drive

**Random Mode:** If the cassette was loaded manually, it must be unloaded manually – before you attempt to have the VLS load the magazine. Refer to the next section for manual removal of a cassette. If the VLS robotics was used to load the cassette via applications software, attempting to "load magazine" from the keyboard will fail – the unit will remain on-line.

**Sequential Mode:** If the cassette was loaded manually, it must be unloaded manually – before you attempt to have the VLS load the magazine. Refer to the next section for manual removal of a cassette. If the VLS robotics was used to load the cassette, the VLS will remember and not allow a "load magazine" from the keyboard. Press **ALT** and then **ENTER** to bring the VLS back on-line.

---

## Manually Removing a Cassette Loaded in the Drive

- Press **ALT** and then **UNLOAD**. This will place the magazine in the unload position.
- Open the VLS door. Remove the magazine from the carrier.
- Press the eject button on the drive (see Figure 12). It may take 30 seconds or more for the drive to eject the cassette.

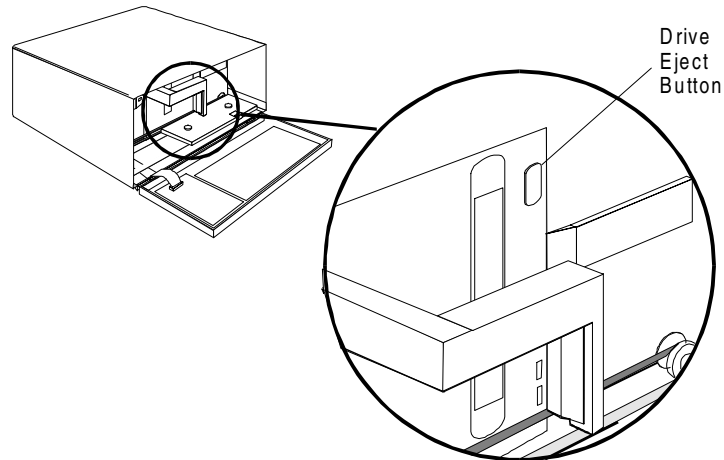

*Figure 12. Typical Position of Drive Eject Button.*

**Note**

Since the Drive Eject Button and Drive Warning Lights are located on the front of the drive, to see them you must be eye-level with the gripper arm of the VLS. Look beyond the arm to the drive.

- Remove the cassette manually.
- Replace the magazine onto the carriage.
- Close the door. You can now initiate the load procedure.

---

## Removing the Magazine from the VLS

Before physically removing the magazine from the carrier, you must first initiate the UNLOAD procedure.

- ❑ Make sure there is no cassette in the drive. If there is, go to the next procedure, *Removing the Magazine while a Cassette is in Drive*

**Note**

You cannot initiate an UNLOAD, or remove the magazine, if the door is locked. When the Locked light is on, the VLS ignores the LOAD and UNLOAD buttons.

- ❑ Press **ALT** and then **UNLOAD** and wait until the unload procedure is finished. (If the carriage is not in the unload position, it will move to the right. In addition, the grippers on the pick arm will close.) Press the Magazine Release on the carriage. See Figure 13. The magazine will release from the holding pins.

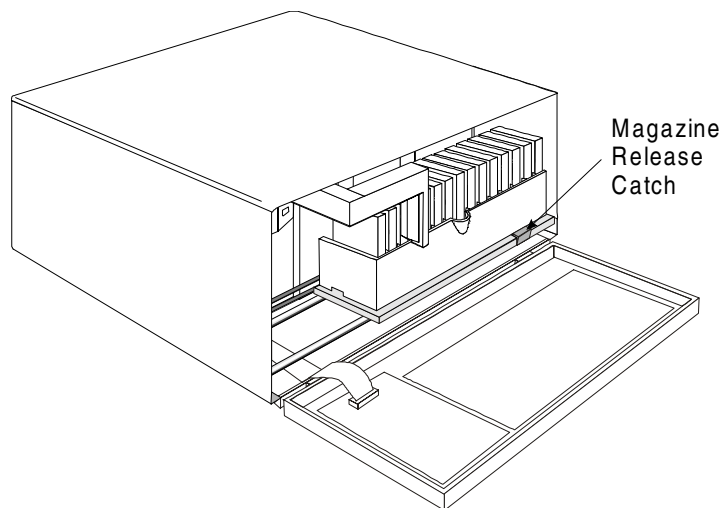

*Figure 13. The Magazine Release*

- ❑ Grab the thumb handle on the magazine and pull the right side of the magazine toward you. The magazine will come out at a 30-40 degree angle.



- 
- Place the transparent cover over the magazine and store the unit in a cool, dry place.

**Note**

*Make sure you have labeled each cassette as to magazine and slot number. If you drop the magazine without the cover on, the cassettes will fall out.*

---

## Removing the Magazine while a Cassette is in the Drive

If you wish to remove the magazine but there is a cassette in the drive, do the following:

- Open the VLS door.
- Press the eject button on the drive (see Figure 12).
- Close the door of the VLS. It will take about 30 seconds for the drive to unload the tape.
- Press **ALT** and then **UNLOAD**. The arm will return the cassette to the magazine slot and the VLS will move the magazine to the unload position.
- Remove the magazine as noted earlier.

---

## Loading an Individual Cassette

If for some reason you need to use a single cassette, you can load it manually (this operation is the same as loading a cleaning cassette).

- Unload the magazine by pressing **ALT** and then **UNLOAD**. The magazine will move completely to the right.
- Open the door and remove the magazine from the carriage. (See previous instructions).

- 
- ❑ Insert the cassette into the drive opening with the label side to your left and the write-protect switch positioned down. Apply steady pressure on the back of the cassette until the autoloading mechanism takes the cassette and loads it into the drive. The cassette is now in a semi-loaded state. If the humidity level is acceptable, the drive threads the tape, initiates a load sequence and goes on-line. The drive will take approximately 20 seconds to load the cassette.

**Note**

If the humidity on the internal head-drum is excessive, the cassette will not be accepted.

If you should ever experience this condition, allow the system to stabilize to the surrounding temperature and humidity and try again.

- ❑ Close the door and initiate desired program.
- ❑ If the drive does not eject the cassette when the program is finished, open the VLS door (the gripper arm should still be fully extended) and press the drive eject button (refer back to Figure 12 if necessary). It will take about 30 seconds for the drive to eject the cassette.

If the normal eject procedure fails to eject a cassette, a Power Eject can be initiated. Press and hold the drive's Eject button. The upper LED (on the drive) will begin flashing amber, as it does during a normal Eject cycle. Holding down the Eject button for 10 seconds will initiate a Power Eject cycle. The cassette will be ejected immediately. ***Using the Power Eject function may cause a tape to be generated that does not conform to the format standard.*** After the cassette is ejected, the drive will reset.

**Warning**

Power Eject should only be used as a last resort in case of an apparent drive failure, or if there is no other way to eject a cassette.

---

## Removing a Cassette from the Magazine

The data cassettes easily slip into and out of the slots of the magazine. To remove a cassette, simply grasp it with two fingers and pull up. Make sure each cassette is labeled so you know the contents (and where it belongs in the magazine sequence).

---

## Storing the Magazine

Store magazines in a dry, cool environment. Always keep the dust cover on the magazine.

The removable magazine allows for long-term archiving or off-site safety storage of groups of data.

You can duplex multiple changers so your system can mirror data backups on each separate unit. With duplexing you have real time data assurance and the ability to remove one magazine set for off-site storage while the other remains for on-line data access.

---

## Cleaning the Drive Head

### **Caution**

Using cloth swabs, cotton swabs, cleaning agents, or *unapproved* cleaning cassettes will void the warranty. Use only an *adic* recommended cleaning cassette. Audio DAT cleaning cassettes do not have the proper ID hole configuration to initiate the cleaning cycle: their use will cause excessive head-wear (voiding the warranty).

To prevent contamination of the drive and damage to the heads, do not use the cleaning cassette for more than the number of cleaning cycles specified on the cassette label. Discard the cleaning cassette after you have used it the specified number of cleaning cycles. *Do not attempt to rewind the material in the cleaning cassette and reuse it.*

---

Clean the drive head and tape path after every 8-10 tape motion hours (about once a week under typical use). You should also clean after the first use of a new tape cassette.

As an absolute visual reminder, the drive status LEDs will flash the Media Caution indication during cassette load/unload operations after approximately 24 hours of head-tape motion since the last cleaning. To see the status LEDs, the magazine must be in the unloaded position and you must look at the drive (see Figure 13). ***We urge you to clean the drive as soon as possible after the LEDs begin flashing the Media Caution indication.***

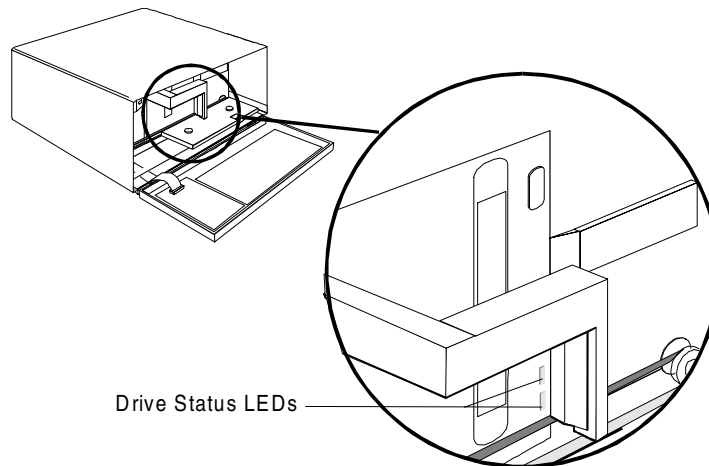

Figure 13. Typical Position of Drive LEDs

Please follow these cleaning directions carefully to assure that no damage will occur to the tape drive, VLS or media.

- Unload the magazine by pressing **ALT** and then **UNLOAD**. The magazine will move completely to the right .
- Open the VLS door and remove the magazine from the carriage.
- Check the usage record on the label of the cleaning cassette to make sure that there is at least one cleaning cycle remaining. If there are no cleaning cycles remaining, discard the cleaning cassette and use a new one. If you attempt to insert a cleaning cassette which is fully used, the drive will eject the cassette immediately and will not reset the internal 24-hour cleaning timer. Both drive LEDs will continue to

---

flash amber during cassette load/unload operations. Figure 14 shows a sample cleaning cassette with the label on which to write the date of each use.

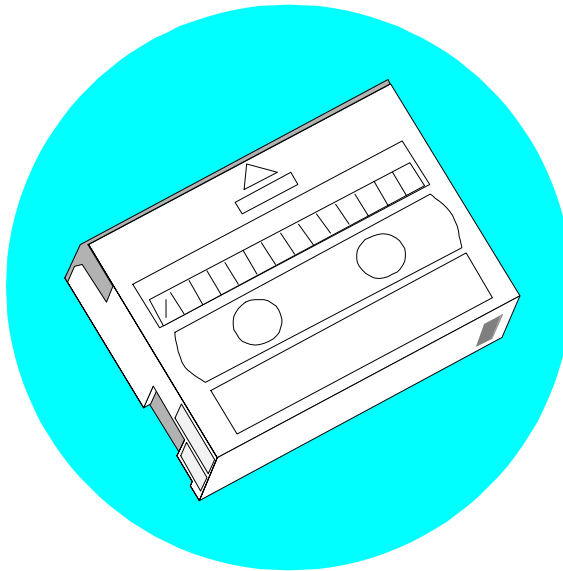
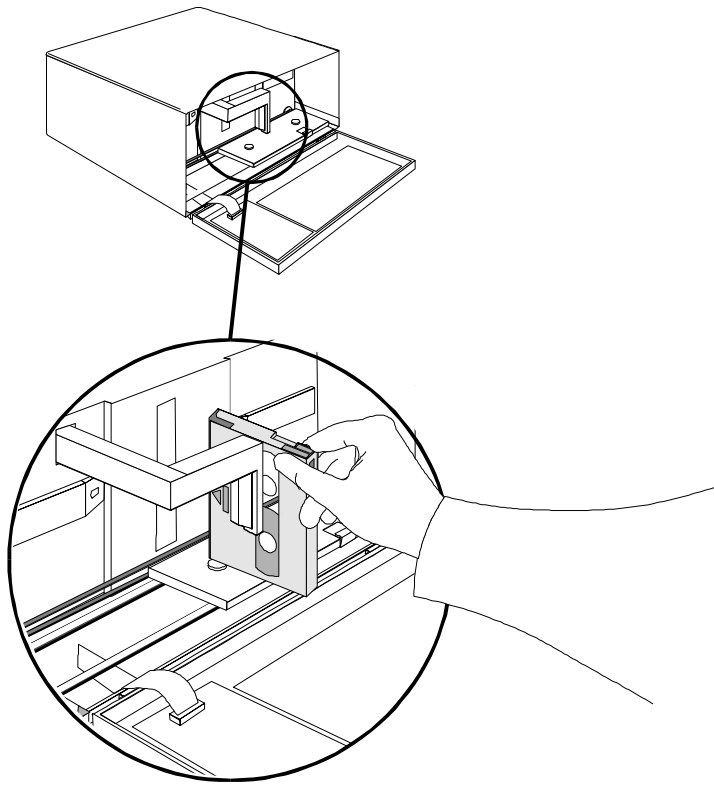

*Figure 14. Representative Cleaning Cassette*

**Caution**

DO not attempt to RE-USE or REWIND the cleaning cassette after all the cleaning cycles (approx. 20) have been used.

- ❑ Insert the cleaning cassette into the drive opening (see Figure 15). The drive will load the cassette and automatically begin the cleaning process. The cleaning cycle may take from 2 to 3 minutes. The media status LED will flash amber during the entire cleaning cycle.



*Figure 15. Inserting the Cleaning Cassette into the Drive.*

- ❑ When the cleaning is finished the drive will automatically eject the cassette. Remove the cleaning cassette and write the date on the label so you have a record of how many times it has been used and when.
- ❑ To confirm that a cleaning was done, look at the LEDs on the front panel of the drive. If the cleaning cycle was successful, the LEDs will be off. If the cleaning cycle was not performed, the LEDs will continue to flash.
- ❑ Place the magazine onto the carriage. Close the VLS door. Press **ALT** and then **LOAD** to initiate the load procedure.

---

**Caution**

Cleaning cassettes are considerably more abrasive to the drive's recording heads than standard data cassettes. Usage should be kept within the recommended limits, or the warranty may not be applicable to the affected equipment.

The VLS is once again ready for use.

**Caution**

If you encounter a hard error during normal operation, first try a new 4mm data cassette. If this solves the problem, continue on with the new cassette.

If the symptom persists, try one cleaning cycle with the cleaning cassette. If this does not resolve the problem, we recommend that you do NOT use the cleaning cassette again – instead, call the *adic*'s Customer Assistance group.

---

## **Cleaning the Enclosure**

The outside of the enclosure can be cleaned with a damp towel. If you use a liquid all-purpose cleaner, apply it to the towel. Do not directly spray the enclosure.

---

**Blank Page**



# Chapter 5

---

## Troubleshooting and Diagnostics

This Chapter ...

- contains some general suggestions to aid you in solving problems – should you ever run into them.
- includes information on error codes and the built-in diagnostics.

---

## VLS Error Messages

If any component of the VLS is not communicating correctly, a warning message will appear on the front display.

A list of error messages is included on the following page. If the error you see is not on this list, please call **adic** Customer Assistance.

In all cases, after removing the cause of the problem (or if you can't find a cause) push **MENU** to return the VLS to the on-line condition.

If the error message is not listed, try to return to the on-line mode by pressing **ALT** and/or **ENTER**. If that does not work or if you get the error again, call **adic** Customer Assistance and be prepared to tell them what the error message is – and what the conditions are.

---

## Error Messages

**Note**

Some, or all, of the error messages may result from one or more conditions. The definition given is for a single condition only. If you believe that the condition which caused your error message is other than the definition, please call **adic** Customer Assistance at: (206) 883-4357.

Error Name	Description
Source location empty	The source location was empty when the VLS attempted to pick a cartridge from it.
Destination location full	The destination location was full when the VLS attempted to place a cartridge in it.
Mag unload disabled by software	The application has issued the <b>SCSI PREVENT/ALLOW MEDIA REMOVAL</b> command, preventing the magazine from being unloaded.
Can't unload, media in drive	The VLS will unload the magazine only if all drives are empty.
Drive failed to eject media	The VLS attempted to return a cartridge to a magazine slot, but the drive had not previously ejected it.
Unexpected Gripper Arm Sensor break	The VLS sensed that the Gripper Arm Sensor was blocked when it should not have been.
Unexpected Magazine Sensor break	The VLS sensed that the Magazine Sensor was blocked when it should not have been.
No Gripper Arm Sensor break	The VLS sensed that the Gripper Arm Sensor was not blocked when it should have been.
No Magazine Sensor break	The VLS sensed that the Magazine Sensor was not blocked when it should have been.
Unexpected Medium Sensor break	The VLS sensed that the Medium Sensor was blocked when it should not have been.
Unable to return medium to slot	The VLS attempted to return a cartridge to a magazine slot but failed, possibly due to a magazine positioning error.

---

<b>Error Name</b>	<b>Description</b>
Unable to load medium in drive	The VLS attempted to load a cartridge into a drive but failed, possibly due to a drive positioning error.
Door has been opened	The front door of the VLS had been opened, but is now closed.
Door is open	The front door of the VLS is open. This error will appear whenever the front door is opened while power is on.
Operation disabled by keyboard lockout	Whenever the front panel lock is engaged, the keypad is disabled, disabling any off-line operations.
All configured drives are empty	The VLS received a command (through SCSI, or the front panel keypad) to unload medium from a drive, but, since the VLS had not previously loaded a cartridge, the drives are empty.
Slot not empty, can't unload drive	A cartridge is occupying the magazine slot currently aligned with the drive, and the VLS cannot place the cartridge ejected by the drive into this slot.
SCSI RESET OCCURRED	A SCSI RESET has occurred, coming from either the SCSI bus, or from the front panel keypad.
Drive positioning time-out	The drive shuttle failed to position correctly in the allowed time.
Medium incorrectly oriented	The cartridge is incorrectly oriented in the magazine. This can occur when the VLS attempts to load the magazine.
Flash RAM erase failure	The VLS could not successfully erase the Flash RAM during the firmware download process.
Flash RAM write failure	The VLS could not successfully write to the Flash RAM during the firmware download process.
NV-RAM selection failure	The VLS could not successfully select a particular area of the NV-RAM.
NV-RAM write failure	The VLS could not successfully write to the NV-RAM.
Boot ROM checksum failure	The checksum of the boot code in the Boot ROM is incorrect.
Unknown error code XXh	An unknown error has occurred.

---

## Drive Warning Signals

The 4mm drives used in the VLS employ front panel LEDs to indicate SCSI interface activity, drive fault conditions, and cartridge status. Figure 16 is a close-up of the Sony SDT-5000 (SDT-7000/SDT-9000 are the same) drive and the location of the warning LEDs. The LEDs on all other drives are located in approximately the same place. Refer to the following tables for descriptions of the methods employed by different drives to indicate activity, status, and fault conditions.

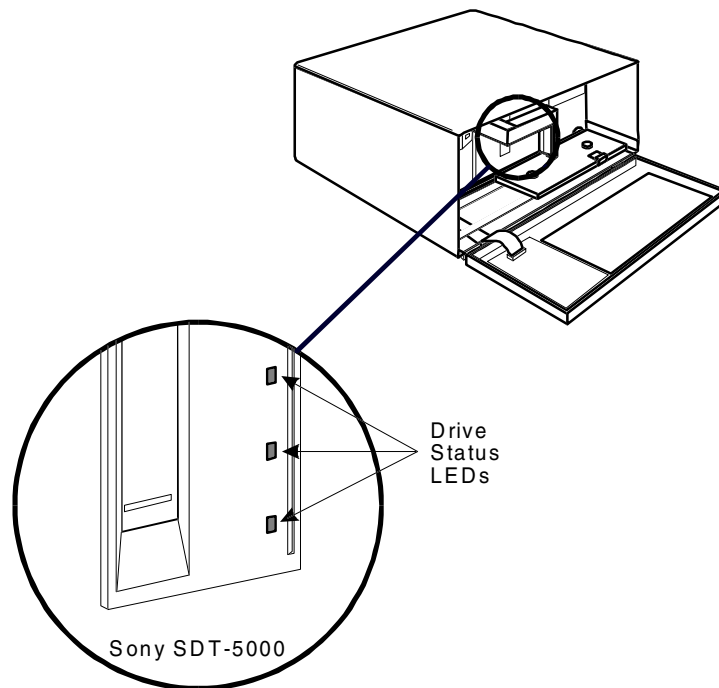

*Figure 16. VLS Drive Status LEDs*

---

<b>Hewlett Packard C1533A/C1537A Drive Status LEDs</b>		
<b>Tape LED (bottom)</b>	<b>Clean LED (top)</b>	<b>Meaning</b>
Flashing green (½ sec on, ½ sec off)	Off	Cartridge activity — load or unload
Fast flashing green (¼ sec on, ¼ sec off)	Off	SCSI activity — read or write
Steady green	Off	Cartridge loaded, drive online
Off	Flashing amber (½ sec on, ½ sec off)	Media Caution Signal
Off	Steady amber	Drive fault
Flashing green (½ sec on, ½ sec off)	Off	Self-test in progress

*Table 3. HP C1533A/C1537A LEDs*

Sony SDT-5000/SDT-7000/SDT-9000 Drive Status LEDs			
Busy LED (Top)	Tape LED (Middle)	Status LED (Bottom)	MEANING
Off	Off	Off	No cartridge present/no activity
On	Off	Off	SCSI activity — read or write
Fast flashing (¼ sec on, ¼ sec off)	Fast flashing (¼ sec on, ¼ sec off)	Off	Drive loading/unloading
Fast flashing (¼ sec on, ¼ sec off)	Fast flashing (¼ sec on, ¼ sec off)	On	Drive loading/unloading with cartridge write protected
Off	On	Fast flashing (¼ sec on, ¼ sec off)	Cleaning cartridge at end of media (no cleaning cycles remaining)
Off	On	Off	Cartridge loaded/no activity
On	On	Off	Cartridge loaded/SCSI activity
Fast flashing (¼ sec on, ¼ sec off)	On	Off	Cartridge loaded/SCSI and drive activity
*	On	On	Cartridge loaded/write protected
*	Long, slow flashing (3½ sec on, ½ sec off)	*	Media Caution Signal — excessive errors detected
Long, slow flashing (3½ sec on, ½ sec off)	*	*	High humidity detected
*	*	Long, slow flashing (3½ sec on, ½ sec off)	Media Caution Signal — predetermined number of tape head motion hours reached
*	*	Flashes once for ¼ sec then stays off for 1 sec	Drive mechanical failure detected
*	*	Flashes twice once for ¼ sec then stays off for 1 sec	Drive circuitry failure detected
Flashes once for ¼ sec then stays off for 1 sec	*	*	Waiting for reset
*	Flashes once for ¼ sec then stays off for 1 sec	*	Waiting for eject

Table 4. Sony SDT-5000/SDT-7000/SDT-9000 LEDs

---

## Environmental Considerations

For best performance of your VLS, please observe the following guidelines:

- If you expose cassettes to temperatures outside the operating limits – 40-113°F (5-40°C) – stabilize them by leaving the cassettes in the operating temperature for a minimum of two hours before you use them.
- Avoid temperature problems by ensuring that the VLS's side and rear are not obstructed so that the drive has adequate ventilation.
- Position the VLS where the temperature is relatively stable (i.e., away from open windows, fan heaters, and doors).
- Avoid leaving cassettes in severe temperature conditions, for example, in a car standing in bright sunlight.
- Avoid transferring data (reading from and writing to cassettes) when the temperature is changing by more than 15°F (10°C) per hour.

---

## When You Call **adic** Customer Assistance

Before calling **adic** Customer Assistance, follow these steps – which will help you take full advantage of your call:

- Review all documentation carefully. (Experience has demonstrated that most questions are answered in your documentation.)
- Be prepared to explain whether the software or hardware has worked properly at anytime in the past. Have you changed anything recently?
- Pinpoint the exact location of your problem, if possible. Note the steps that led to the problem. Are you able to duplicate the same problem or is it a one-time occurrence?
- Note any error messages displayed on your PC screen or file server. Write down the exact error message.



- 
- ❑ If at all possible, call while at your computer, with **adic** 's system installed and turned on.
  - ❑ If running on a network, have all relevant information available (i.e. type, version #, network hardware, etc.).

Be prepared to provide:

- Your name and your Company's name
- Model number
- Serial number of unit (located on the rear face by the power switch)
- Software version numbers
  - device driver
  - archive/restore
- Hardware configuration, including firmware version, date and number
- Type of PC, DOS version, clock speed, RAM, network type, network version, and any special boards installed
- A brief description of the problem
- Where you purchased the **adic** system

Having this information available when you call for customer assistance will enable **adic** to resolve your problem in the most efficient manner possible.

**Note**

Call **adic** Customer Assistance at: (206) 883-4357.

If you wish, you may contact **adic** Customer Service through the **adic** BBS at: (206) 883-3211, or by leaving Internet E-mail at: [support@adic.com](mailto:support@adic.com)

---

## Return for Repair RMA (Return Merchandise Authorization)

When you and **adic** Customer Assistance have determined that you need an RMA number (see previous section *When You Call adic Customer Assistance*), be prepared with the following information:

- Model number, serial number, and a brief, descriptive explanation of the problem.
- Complete address information (be sure you give any mail stops or special codes at the time the RMA is issued).
- If the item is NOT in warranty, you will be charged for the repairs. Therefore, the Customer Assistance personnel will need a P.O. number at the time the RMA number is issued. Until credit information can be obtained by our accounting department, the system may be shipped back COD to first-time customers.
- It is also necessary to send the *complete* system, including the SCSI interface card/controller, interface cables, and the unit. Problems may have been caused by a defective external component and/or the drive itself.

Current labor rates will be quoted at the time the RMA is issued.

Loaner or replacement systems are generally NOT available. In extreme circumstances, they may be arranged for, depending on the nature of the problem and past history with the customer.

Keep the RMA number as a reference if you call to check on the status of an open RMA. It MUST also be written on the outside of the package for identification purposes.

**Note**

Following this RMA procedure will expedite handling, repairs, and the return of equipment.

# Appendix

# A

---

## Installing the Ferrite Bead

This Appendix ...

- ❑ describes how to install a ferrite bead (supplied) on the SCSI cable to assure compliance with EMI/RFI suppression specifications with dual VLS installations.

---

If you are using two or more VLS units on the same SCSI channel, you must install a ferrite bead on the interface cable between the units.

- Clip the clamp-on bead on the cable at any point between the two units. Refer to Figure 17.

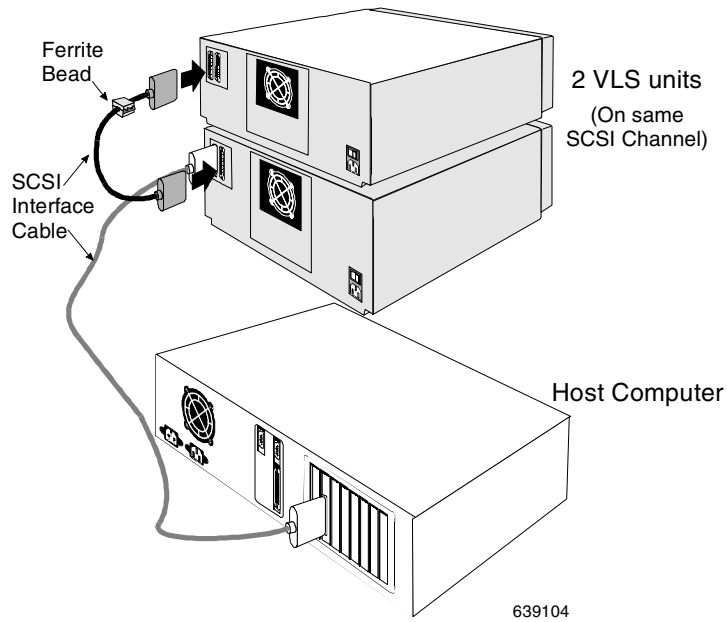

*Figure 17. Installing the Ferrite Bead*

The ferrite bead is required to satisfy the EMI/RFI suppression limits. The bead does not affect the functionality of your system in any way.

# Appendix B

---

## Diagnostics Menu

This Appendix ...

- describes the built-in diagnostic functions as available via the Diagnostics Menu

---

One of the most valuable features of the VLS is the extensive built-in diagnostics. In this Appendix we discuss each of the Diagnostic functions available through the front panel keypad.

To access the Diagnostics Menu, press the **MENU** button. The display will read as follows:



A rectangular display box with a black border. The text inside is in a monospaced font. The top line reads "OFF-LINE MENU" and the second line reads "Config Menu" followed by a small cursor symbol on the right.

Press **DOWN** to access the Diagnostics Menu. Press **ENTER**; a display similar to the following will appear.

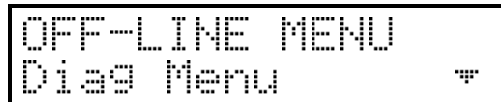

A rectangular display box with a black border. The text inside is in a monospaced font. The top line reads "OFF-LINE MENU" and the second line reads "Diag Menu" followed by a small cursor symbol on the right.

The following items are available under the Diagnostics Menu:

- Error Counters
- Operation Log
- Serial Number
- Position Magazine
- Unload Medium
- Event Counters
- F/W Revision
- Position Drive
- Load Medium
- Unload Drives

Use **UP** or **DOWN** to scroll through the list. Press **ENTER** to choose a particular function.

Use the **ESC** button to return to a previous menu (or to abandon current change).

---

## Error Counters

```
ERROR COUNTERS
nnnnnnnn#cccc
```

Provides a chronological listing (beginning with the last error issued) of the errors encountered by the VLS system. These are VLS internal hardware/firmware errors. This register records each error name and assigns it a sequential number.

nnnnnnnn = Counter name.

cccc = Counter value (0 - 65535)

## Event Counters

```
EVENT COUNTERS
nnnnnnnn#cccc
```

Provides a listing of the various VLS operations and how many times they have occurred.

nnnnnnnn = Counter name.

cccc = Counter value (0 - 65535)

## Operation Log

```
OPERATION NNN ▲▼
SCSI selection ▶
```

Provides a chronological logging (beginning with the latest) of up to 255 operations. These operations can be SCSI commands, operator requested operations, errors, and status operations. This information can be vital for trouble shooting problems. The following is a partial listing of some of the loggable operations. You may encounter other operations not included here.

---

NNN = Logged operation number (1-255).  
When log is full, new operations are  
logged in as operation 255, scrolling the  
old operation 1 off the log.

Power on or user reset

Unit online due to user request

Unit off-line due to user request

Cmd: 03 00 00 00 20 00 (cmd from SCSI host adapter)

SCSI selection by SCSI ID N (N = SCSI ID of host adapter)

SCSI reselection of SCSI ID N

SCSI disconnect from SCSI ID N

SCSI status = 00h (status to SCSI host adapter)

Load magazine

Unload magazine

Door opened

Door closed

Position drive d (d = Drive A or B)

Position magazine to slot ss (ss = 01- 11)

Load from slot ss to drive d

Unload from d to slot ss

ERROR: Can't unload, media in drive(s)

ERROR: Source location empty

ERROR: Unexpected Gripper Arm Sensor brk

Retrying operation



---

## Firmware Revision

```
F/W REVISION
Rev:VV.vv Date:*
```

Provides a record of the internal revision date and number. This information is vital for trouble shooting problems. Be prepared to provide this information to your reseller's Customer Assistance personnel if you ever need to talk with them. The following chart shows what each character in the sequence means.

VV	=	Major version number (00-99)
vv	=	Minor version number (00-99)
mm	=	Build-date month (01 - 12)
dd	=	Build-date day (01 - 31)
yy	=	Build-date year (00 - 99)
cccc	=	Internal checksum (0000 - FFFF)

## Serial Number

```
SERIAL NUMBER
ccssymdd r1
```

Provides a record of the unit's unique hardware serial number. This information is vital for trouble shooting problems. Be prepared to provide this information to your reseller's Customer Assistance personnel if you ever need to talk with them. The following chart shows what each character in the sequence means.

cc	=	Model code
ss	=	Sequence number
y	=	Year code (one digit only)
m	=	Month code (one digit only)
dd	=	Day code
r	=	Revision level

---

1 = Modification level

### Position Drive

```
POSITION DRU
Position drive:A
```

Use the Position Drive function to line a drive up with the cassette window. Select drive A or B using **UP** or **DOWN**. Press **ENTER** to activate.

### Position Magazine

```
POSITION MAG
Slot number:05
```

Use the Position Magazine function to line up the magazine with the on-line drive at a particular slot. Select the slot number using **UP** or **DOWN**. Press **ENTER** to activate.

This option is usually used for diagnostics only by a trained technician.

ss = Slot number (01 - 15)

### Load Medium

```
LOAD MEDIUM
Slot:ss Drive:d
```

The Load Medium function is used to line up the magazine with a particular drive at a particular magazine slot and load that cassette.

Use **LEFT** or **RIGHT** to select the desired field. Select the slot and/or drive using **UP** or **DOWN**. Press **ENTER** to activate.

This option is usually used for diagnostics only by a trained technician.

ss = Slot number (01 - 11)





d = Drive (A or B)

---

## Unload Medium

```
UNLOAD MEDIUM
Slot:ss Drive:d
```

The Unload Medium function is used to line up the magazine with a particular drive at a particular slot so that the cassette will be placed in that slot when ejected.

Use **LEFT**  or **RIGHT**  to select the desired field. Select the slot or drive using **UP**  or **DOWN** . Press **ENTER** to activate.

ss            =    Slot number (01 - 11)  
d             =    Drive (A or B)

### Note

If you have disabled a drive in the Drive Configuration Option (selected from the Configuration Menu) or there is no drive present, that drive field is not selectable.

This option is usually used for diagnostics only by a trained technician.

## Unload Drives

```
UNLOAD DRIVES
All configured *
```

The Unload Drives function provides a message prompting the operator to manually eject media from the drive(s) and then returns the media to the magazine, or informs the operator that the drive(s) are empty.

If the VLS thinks that media is present in the drive(s) it will perform the following steps:

1. Aligns drive with cartridge window.
2. Verifies appropriate magazine slot is empty.
3. Aligns magazine slot with cartridge window.
4. Displays message: "Manually eject media".

- 
5. Waits until door is opened, then closed (because operator should have opened door, pressed eject button on drive, then closed door).
  6. Checks that cartridge in transit sensor detects presence of media (because drive ejected cartridge).
  7. Returns media to magazine.
  8. Aligns second drive with cartridge window (if VLS thinks both drives contain media).
  9. Repeats steps 2 through 7.

If the VLS thinks that the drive(s) are empty it will display: “All configured drives are empty”.

This option is usually used for diagnostics only by a trained technician.

# Appendix C

---

## Glossary

This Appendix ...

- contains terms and definitions of common expressions used with the VLS and the 4mm drive.

---

<b>ALT</b>	This button is used to activate the load/unload functions on the front panel.
<b>byte</b>	8 bits or one character.
<b>C</b>	Celsius (Centigrade).
<b>cassette</b>	A storage medium item. A cassette is sometimes called a tape or cartridge and is capable of storing vast amounts of magnetically-written data. Some cassettes can store more than 24 GB of data. The 4mm drive in the VLS uses data-grade DDS cassettes.
<b>cleaning cassette</b>	Media used to clean the drive heads and tape path.
<b>cm</b>	Centimeter (0.3937 inches).
<b>DAT</b>	Digital Audio Tape.
<b>DDS</b>	DDS (Digital Data Storage) is the original industry-standard data interchange recording format that supports the use of DAT for computer applications. The DDS format is an overlay to the basic DAT audio format. Under DDS, fixed capacity data groups are constructed on tape with pairs of tracks (or frames) from the audio format.
<b>DDS-3</b>	DDS-3 is an industry-standard data interchange recording format built on the strengths of the DDS format, combined with increased performance. The DDS-3 format allows writing of compressed entities and uncompressed records on the same tape. The DDS-3 format is written to MP+ media only, presently available exclusively in 125-meter data cassettes.
<b>DDS-3 cassette</b>	Media used with the DDS-3 DAT tape drive in the VLS 4mm unit. It is a data-quality 4mm metal-particle cassette. These cassettes require no formatting or other media conditioning before use.

---

<b>DDS-3 drive</b>	Drive that may be used in the 4mm VLS. It is an enhanced 4mm digital helical-scan cassette tape subsystem.
<b>FCC</b>	Federal Communications Commission
<b>ferrite bead</b>	a device required to suppress radio noise in certain conditions to meet specifications
<b>GB</b>	gigabyte (1 GB = 1,024 Megabytes)
<b>HSM</b>	Hierarchical Storage Management – a system where different types of storage medium are used based on cost and time efficiency. For example, for fastest access, data is usually stored on a local drive. If you have a very large file that is needed occasionally, you may store it on a tape in a VLS magazine, or on an optical drive. In an HSM system, the data source should be transparent to the user.
<b>Hz</b>	Hertz (replacement for "cycles-per-second").
<b>initiator</b>	A host computer system that requests an operation to be performed by a target.
<b>KB</b>	Kilobyte (1 KB = 1,024 bytes)
<b>keypad</b>	Front panel on the VLS with 8 buttons used to activate the various functions of the VLS.
<b>LCD</b>	Liquid Crystal Display, a commonly used alphanumeric display that responds to specified input voltages and signals
<b>LED</b>	Light Emitting Diode, a commonly used semiconductor device that glows when supplied with a specified voltage.

---

<b>load</b>	The process where the VLS checks each slot to see if a cassette is physically present, and if so, whether the orientation of the cassette in the magazine is correct. It also places the magazine in position for the first cassette to be inserted into the drive. In sequential mode, the first cassette is physically inserted into the drive.
<b>magazine</b>	The item that holds the tape cassettes for use within the VLS. The 4mm magazine holds 15 cassettes. The magazine provides long-term storage of cassettes.
<b>MB</b>	megabyte (1 MB = 1,024 Kilobytes)
<b>mm</b>	millimeter (0.03937 inches)
<b>POST</b>	Power-On Self-Test is a built-in self-test for the 4mm drive. POST automatically occurs each time the VLS powers up.
<b>random-access mode</b>	Gives the software the ability to communicate with the robotics in such a way as to be able to access the cassettes in the magazine (and data on the cassettes) in any order. (Also, see sequential-access mode.)
<b>RMA</b>	Return Merchandise Authorization.
<b>RMA number</b>	An identifying number given to a customer who needs to return equipment for repair, whether under warranty or not.
<b>SCSI</b>	Small Computer System Interface. An industry standard for connecting peripheral devices and their controllers to a microprocessor. The SCSI defines both hardware and software standards for communication between a host computer and a peripheral.
<b>SCSI address</b>	The octal representation of the unique address (0 to 7) assigned to a SCSI device.



---

<b>SCSI bus</b>	Signal path or line shared by the devices on the same SCSI channel. Information is often sent to all devices throughout the same bus; only the device to which it is addressed will accept it.
<b>sequential-access mode</b>	The cassettes in the magazine are inserted into the drive in a sequential manner, i.e. number 1 is first, number 2 is second, etc. When the last cassette is ejected from the drive, the sequence will either stop and the VLS will issue an error message or loop back to the first cassette. (Also, see random-access mode.)
<b>slot</b>	A slot is the place within the magazine where the media is placed. Each slot has a reference position, i.e. position 1 through position 15.
<b>terminator</b>	a physical block which tells the SCSI bus that this is the end of the line. A terminator is required at both ends of a SCSI bus. A bus may be terminated internally (on a device inside the host system) or externally on a peripheral device.
<b>unload</b>	The process which returns the magazine to its resting position where it can be removed from the VLS unit.
<b>VLS</b>	Virtual Library System.

---

**Blank Page**

# Appendix D

---

## Specifications

This Appendix ...

- ❑ contains terms and definitions of common expressions used with the VLS and the 4mm drive.

---

# Specifications

## Drive

Data Capacity:	Up to 24 GB per 125-meter DDS-3 cassette (DDS-3 drive w/2:1 compression) Up to 360 GB per 15 cassette magazine (DDS-3 drive w/2:1 compression)
Type:	HP model C1533A (DDS-2) HP model C1537A (DDS-3) Sony model SDT-5000 (DDS-2) Sony model SDT-7000 (DDS-2) Sony model SDT-9000 (DDS-3)  (Optional dual drives available)
Data Transfer Rate:	Up to 288 MB/min. w/2:1 compression (dual Sony SDT-9000) Up to 240 MB/min. w/2:1 compression (dual HP C1537A drives)
Load Time:	20 seconds

## Changer

Magazine:	15 Cassettes
Media type:	DDS, 4mm metal-particle cassettes
Cassette Change:	8 seconds, maximum
Indicators/Controls:	8 button keypad with LCD menu display, POWER LED and LOCKED LED to monitor and control system status, diagnostics and configuration
Interface:	SCSI-2

## Reliability

Maintenance:	Use cleaning cassette every 8-10 hours of tape use
MSBF:	Greater than 100,000 cassette changes (net, drive and media)
MTBF:	More than 80,000 power-on hours
MTTR:	Within 30 minutes

---

## Physical

Dimensions: 17.4" (w) x 15.8" (d) x 8.0" (h)  
Weight: 30 lb. (32 lb. with dual drives)

## Power Consumption

Less than 65 Watts

## Environment

Electrical: 100-240 VAC Automatic AC line voltage selection  
Temperature: 10° C to 40° C (Operating)  
-40° C to 70° C (Storage/Shipping)  
Humidity: 20% to 80% (Operating)  
5% to 95% (Storage/Shipping)  
Vibration: 0.25g (5-500 Hz) (Operating)  
0.5g (5-500 Hz) (Storage/Shipping)  
Shock: 2g Operating  
30g Storage/Shipping

---

**Blank Page**



---

## Index

---

## —A—

alarm mode, 20  
alarm sound, 20  
archiving, 39

## —B—

backup software, *xii*, 2, 6, 14, 16  
bail locks, 10, 11  
Busy LED, 51  
Buzzer Configuration, 19, 20, 21

## —C—

cassette label, 30, 39  
Changer Cassette Change Time, 71  
Changer Indicators/Controls, 71  
Changer Interface, 71  
Changer Magazine Capacity, 71  
Changer Maintenance, 71  
Changer Media Type, 71  
Clean LED, 50  
cleaning cassette, 6, 37, 39, 40, 41, 42, 43, 66, 71  
cleaning confirmation, 42  
cleaning cycle, 39, 40  
Cleaning the Drive Head, 6, 28, 39  
Cleaning the Enclosure, 44  
Cleaning the Fan Filter, 43  
Configuration Menu, 19, 20  
Connecting Multiple VLS Units, 12  
Connecting the Interface Cables, 10  
*Copyright*, *ii*, *iii*  
Cycle Test, 19

## —D—

DAT, 5, 28, 39, 66  
Data Transfer Rate, 71  
DDS, 5, 66

DDS Media, 28  
DDS-3, 66  
DDS-3 cassette, 66  
DDS-3 drive, 67  
Declaration of Conformity, *v*  
Diagnostics Menu, 19, 25, 58  
Dimensions, 72  
disabling drives, 23  
Drive Configuration, 19, 20, 23  
drive eject button, 35, 38, 64  
Drive Load Time, 71  
Drive Status LEDs, 50, 51  
drive warning LEDs, 28  
Drive Warning Signals, 49  
duplex, 39  
dust cover, 4, 29, 30, 39

## —A—

EMI/RFI Compliance, *iv*  
EMI/RFI limit specification, *iv*  
EMI/RFI suppression limits, 56  
Environmental Considerations, 52  
Error Counters, 19, 59  
Error Messages, 46  
Event Counters, 19, 58, 59

## —F—

ferrite bead, *iv*, 56, 67  
Firmware Revision, 19, 58, 61  
Front Panel Keypad, 4, 17, 20, 58, 67, 71  
Front Panel LCD Display, 17, 71  
Front Panel Lock, 17  
Front Panel Locked LED, 17  
Front Panel MENU Button, 17, 20, 46, 58  
Front Panel Switches and Indicators, 16



---

## —G—

gripper arm, 38, 60

## —H—

Hierarchical Storage Management, 2, 67  
host computer, *x*, *xii*, 2, 7, 10, 13, 14, 16,  
67, 68  
HSM, 2, 67  
humidity, 51, 72

## —I—

I/O connector, 7  
Inserting Data Cassettes into Magazine, 29  
Inserting Magazine into VLS, 31  
Installing the Backup Software, 14  
Installing the SCSI Host Interface, 7  
interface cable, *iv*, 10, 12, 56

## —L—

Load Magazine, 60  
Load Medium, 19, 58, 62  
Loading Individual Cassette, 37  
Loading Magazine with Cassette in Drive,  
34  
Loading the Magazine, 33  
Locked LED, 71

## —M—

magazine, *xi*, 4, 5, 16, 17, 23, 28, 29, 30,  
31, 32, 33, 34, 35, 36, 37, 39, 40, 42,  
62, 63, 64, 67, 68, 69  
magazine position pin, *xi*, 31, 32, 33  
Magazine Release, 36  
Main Menu, 18  
mean swaps between failures (MSBF), 71  
mean time between failures (MTBF), 71

mean time to repair (MTTR), 71  
media, 4, 5, 25, 28, 29, 40, 41, 51, 60, 63,  
64, 66, 69, 71  
Media Caution indication, 6, 28, 40, 50,  
51  
Mode of operation, 2

## —N—

Necessary tools, 3

## —O—

off-line menu, 20  
off-line mode, 17, 22  
Off-line Time, 19, 20, 22  
off-site storage, 39  
on-line data access, 39  
On-line Mode, 19, 20, 23, 46  
operating environment, 3  
Operation Log, 19, 58, 59

## —P—

packing materials, 3  
pick arm, 17  
Position, 25  
Position Drive, 19, 58, 60, 62  
Position Magazine, 19, 58, 60, 62  
Power Consumption, 72  
Power Cord Protection, *vi*  
Power Eject, 38  
Power LED, 17, 71  
Powering on the System, 13  
Preparing the Host Computer, 7

## —Q—

Quickstart Guide, *ix*

---

## —R—

random-access mode, 2, 13, 23, 24, 33, 34, 68, 69  
Rear Panel AC Power Connector, 18  
Rear Panel Power Switch, 18  
Rear Panel SCSI I/O Connectors, 18  
Rear Panel Switches and Connectors, 18  
Removing a Cassette Loaded in Drive, 35  
Removing Cassette from the Magazine, 39  
Removing Magazine from VLS, 36  
Removing Magazine with Cassette in Drive, 36, 37  
Return for Repair, 54  
Return Merchandise Authorization, 54, 68  
RMA, 54, 68  
RMA number, 54, 68

## —S—

Safety Warnings, vi  
SCSI address, 68  
SCSI bus, 69  
SCSI cable, 11  
SCSI chain, x, 7  
SCSI channel, iv, 11, 12, 18, 56, 69  
SCSI commands, 59  
SCSI connections, 2  
SCSI connector, x, 10, 11  
SCSI controller, 3  
SCSI host adapter, 60  
SCSI ID, 12, 60  
SCSI ID configuration, 19, 20, 21  
SCSI interface cable, x, 2, 10, 11  
SCSI Parity, 19, 20, 21, 22  
sequential-access mode, xi, 2, 13, 24, 33, 34, 68, 69

Sequential-Access Mode Configuration, 19, 20, 24  
Serial Number, 19, 58, 61  
shielded cable, iv, 10  
Shock, 72  
Small Computer System Interface, 68  
Space requirements, 2  
Specifications, iii, 71  
Status LED, 51  
storage environment, 3  
Storing the Magazine, 39

## —T—

Tape LED, 50, 51  
temperature, 72  
terminator, x, 11, 69

## —U—

Unload Drives, 58, 63  
Unload Magazine, 60  
Unload Medium, 19, 58, 63  
Unpacking and Inspecting, 3

## —V—

Vibration, 72

## —W—

warranty, ii, iii, 39, 68  
Weight, 72  
When You Need Assistance, 52  
Write EEPROM Mode, 19, 26  
write-protect switch, 5, 28, 38